

Geosynthetic Reinforced Soil Integrated Bridge System Interim Implementation Guide

PUBLICATION NO. FHWA-HRT-11-026

JANUARY 2011



U.S. Department of Transportation
Federal Highway Administration

Research, Development, and Technology
Turner-Fairbank Highway Research Center
6300 Georgetown Pike
McLean, VA 22101-2296

FOREWORD

Geosynthetic Reinforced Soil (GRS) technology consists of closely spaced layers of geosynthetic reinforcement and compacted granular fill material. GRS has been used for a variety of earthwork applications since the U.S. Forest Service first used it to build walls for roads in steep mountain terrain in the 1970s. Since then, the technology has evolved into the GRS Integrated Bridge System (IBS), a fast, cost-effective method of bridge support that blends the roadway into the superstructure. GRS-IBS includes a reinforced soil foundation, a GRS abutment, and a GRS integrated approach. The application of IBS has several advantages. The system is easy to design and economically construct. It can be built in variable weather conditions with readily available labor, materials, and equipment and can easily be modified in the field. This method has significant value when employed for small, single-span structures meeting the criteria described in this manual.

As a result of the demonstrated performance of GRS-IBS, the technology was selected for the Federal Highway Administration's (FHWA) Every Day Counts initiative, aimed at accelerating implementation of proven, market-ready technologies. This manual is the first in a two-part series and outlines the design and construction of GRS-IBS. The second document is a synthesis report to substantiate the design method. Both documents are a collaboration between many disciplines within FHWA: geotechnical, structural, hydraulic, maintenance, and pavement engineering.

Jorge Pagán-Ortiz
Director, Office of Infrastructure
Research and Development

Notice

This document is disseminated under the sponsorship of the U.S. Department of Transportation in the interest of information exchange. The U.S. Government assumes no liability for the use of the information contained in this document. This report does not constitute a standard, specification, or regulation.

The U.S. Government does not endorse products or manufacturers. Trademarks or manufacturers' names appear in this report only because they are considered essential to the objective of the document.

Quality Assurance Statement

The Federal Highway Administration (FHWA) provides high-quality information to serve Government, industry, and the public in a manner that promotes public understanding. Standards and policies are used to ensure and maximize the quality, objectivity, utility, and integrity of its information. FHWA periodically reviews quality issues and adjusts its programs and processes to ensure continuous quality improvement.

TECHNICAL REPORT DOCUMENTATION PAGE

1. Report No. FHWA-HRT-11-026	2. Government Accession No.	3. Recipient's Catalog No.	
4. Title and Subtitle Geosynthetic Reinforced Soil Integrated Bridge System, Interim Implementation Guide		5. Report Date January 2011	
		6. Performing Organization Code:	
7. Author(s) Michael Adams, Jennifer Nicks, Tom Stabile, Jonathan Wu, Warren Schlatter, and Joseph Hartmann		8. Performing Organization Report No.	
9. Performing Organization Name and Address Office of Infrastructure Research and Development Federal Highway Administration 6300 Georgetown Pike McLean, VA 22181		10. Work Unit No.	
		11. Contract or Grant No.	
12. Sponsoring Agency Name and Address Federal Highway Administration U.S. Department of Transportation 1200 New Jersey Avenue, SE Washington, DC 20590		13. Type of Report and Period Covered	
		14. Sponsoring Agency Code	
15. Supplementary Notes The FHWA Contracting Officer's Technical Representative (COTR) was Mike Adams, HRDS-40.			
16. Abstract This manual outlines the state-of-the-art and recommended practice for designing and constructing Geosynthetic Reinforced Soil (GRS) technology for the application of the Integrated Bridge System (IBS). The procedures presented in this manual are based on 40 years of State and Federal research focused on GRS technology as applied to abutments and walls. This manual was developed to serve as the first in a two-part series aimed at providing engineers with the necessary background knowledge of GRS technology and its fundamental characteristics as an alternative to other construction methods. The manual presents step-by-step guidance on the design of GRS-IBS. Analytical and empirical design methodologies in both the Allowable Stress Design (ASD) and Load and Resistance Factor Design (LRFD) formats are provided. Material specifications for standard GRS-IBS are also provided. Detailed construction guidance is presented along with methods for the inspection, performance monitoring, maintenance, and repair of GRS-IBS. Quality assurance and quality control procedures are also covered in this manual. The second part of this series (FHWA-HRT-11-027) is a synthesis report that covers the background of GRS-IBS and provides other supporting information to substantiate the design method.			
17. Key Words Geosynthetic Reinforced Soil (GRS), Integrated Bridge System (IBS), Design, Construction, Performance test, Geosynthetic, material specifications, Quality assurance, Quality control		18. Distribution Statement	
19. Security Classif. (of this report) Unclassified	20. Security Classif. (of this page) Unclassified	21. No. of Pages 169	22. Price

SI* (MODERN METRIC) CONVERSION FACTORS

APPROXIMATE CONVERSIONS TO SI UNITS

Symbol	When You Know	Multiply By	To Find	Symbol
LENGTH				
in	inches	25.4	millimeters	mm
ft	feet	0.305	meters	m
yd	yards	0.914	meters	m
mi	miles	1.61	kilometers	km
AREA				
in ²	square inches	645.2	square millimeters	mm ²
ft ²	square feet	0.093	square meters	m ²
yd ²	square yard	0.836	square meters	m ²
ac	acres	0.405	hectares	ha
mi ²	square miles	2.59	square kilometers	km ²
VOLUME				
fl oz	fluid ounces	29.57	milliliters	mL
gal	gallons	3.785	liters	L
ft ³	cubic feet	0.028	cubic meters	m ³
yd ³	cubic yards	0.765	cubic meters	m ³
NOTE: volumes greater than 1000 L shall be shown in m ³				
MASS				
oz	ounces	28.35	grams	g
lb	pounds	0.454	kilograms	kg
T	short tons (2000 lb)	0.907	megagrams (or "metric ton")	Mg (or "t")
TEMPERATURE (exact degrees)				
°F	Fahrenheit	5 (F-32)/9 or (F-32)/1.8	Celsius	°C
ILLUMINATION				
fc	foot-candles	10.76	lux	lx
fl	foot-Lamberts	3.426	candela/m ²	cd/m ²
FORCE and PRESSURE or STRESS				
lbf	poundforce	4.45	newtons	N
lbf/in ²	poundforce per square inch	6.89	kilopascals	kPa

APPROXIMATE CONVERSIONS FROM SI UNITS

Symbol	When You Know	Multiply By	To Find	Symbol
LENGTH				
mm	millimeters	0.039	inches	in
m	meters	3.28	feet	ft
m	meters	1.09	yards	yd
km	kilometers	0.621	miles	mi
AREA				
mm ²	square millimeters	0.0016	square inches	in ²
m ²	square meters	10.764	square feet	ft ²
m ²	square meters	1.195	square yards	yd ²
ha	hectares	2.47	acres	ac
km ²	square kilometers	0.386	square miles	mi ²
VOLUME				
mL	milliliters	0.034	fluid ounces	fl oz
L	liters	0.264	gallons	gal
m ³	cubic meters	35.314	cubic feet	ft ³
m ³	cubic meters	1.307	cubic yards	yd ³
MASS				
g	grams	0.035	ounces	oz
kg	kilograms	2.202	pounds	lb
Mg (or "t")	megagrams (or "metric ton")	1.103	short tons (2000 lb)	T
TEMPERATURE (exact degrees)				
°C	Celsius	1.8C+32	Fahrenheit	°F
ILLUMINATION				
lx	lux	0.0929	foot-candles	fc
cd/m ²	candela/m ²	0.2919	foot-Lamberts	fl
FORCE and PRESSURE or STRESS				
N	newtons	0.225	poundforce	lbf
kPa	kilopascals	0.145	poundforce per square inch	lbf/in ²

*SI is the symbol for the International System of Units. Appropriate rounding should be made to comply with Section 4 of ASTM E380.
(Revised March 2003)

TABLE OF CONTENTS

CHAPTER 1. GEOSYNTHETIC REINFORCED SOIL INTEGRATED BRIDGE SYSTEM	1
1.1. INTRODUCTION.....	1
1.2 BENEFITS OF GRS-IBS	3
CHAPTER 2. NOTATION, ABBREVIATIONS, AND TERMINOLOGY.....	5
2.1 NOTATION.....	5
2.2 ABBREVIATIONS.....	11
2.3 TERMINOLOGY	12
CHAPTER 3. MATERIALS.....	15
3.1 INTRODUCTION.....	15
3.2 FACING ELEMENTS.....	15
3.3 BACKFILL MATERIAL.....	17
3.3.1 GRS Abutment Backfill.....	17
3.3.2 RSF Backfill.....	20
3.3.3 Integrated Approach Backfill.....	20
3.4 GEOSYNTHETIC	20
3.5 MISCELLANEOUS MATERIALS	23
CHAPTER 4. DESIGN METHODOLOGY FOR GRS-IBS	25
4.1 OVERVIEW OF GRS-IBS DESIGN METHOD.....	25
4.2 BASIC DESIGN STEPS FOR GRS-IBS	27
4.3 GRS-IBS DESIGN GUIDELINES	28
4.3.1 Step 1—Establish Project Requirements	28
4.3.2 Step 2—Perform a Site Evaluation	29
4.3.3 Step 3—Evaluate Project Feasibility	30
4.3.4 Step 4—Determine Layout of GRS-IBS.....	30
4.3.5 Step 5—Calculate Applicable Loads.....	35
4.3.6 Step 6—Conduct an External Stability Analysis.....	39
4.3.7 Step 7—Conduct Internal Stability Analysis.....	44
4.3.8 Step 8—Implement Design Details	50
4.3.9 Step 9—Finalize Material Quantities and Layout	53
4.4 DESIGN EXAMPLE: BOWMAN ROAD BRIDGE, DEFIANCE COUNTY, OH	54
4.4.1 Step 1—Establish Project Requirements	54
4.4.2 Step 2—Site Evaluation.....	56
4.4.3 Step 3—Evaluate Project Feasibility	58
4.4.4 Step 4—Determine Layout of GRS-IBS.....	58
4.4.5 Step 5—Calculate Loads.....	59
4.4.6 Step 6—Conduct an External Stability Analysis.....	60
4.4.7 Step 7—Conduct Internal Stability Analysis.....	63
4.4.8 Step 8—Implement Design Details	70
4.4.9 Step 9—Finalize Material Quantities and Layout	70

CHAPTER 5. SPECIAL REQUIREMENTS FOR HYDRAULIC AND SEISMIC CONDITIONS.....	71
5.1 INTRODUCTION.....	71
5.2 HYDRAULIC DESIGN.....	71
5.3 HYDRAULIC DESIGN CONSIDERATIONS.....	71
5.4 SEISMIC DESIGN.....	73
5.5 IMPACT EVENTS.....	73
CHAPTER 6. IN-SERVICE PERFORMANCE.....	75
6.1 INTRODUCTION.....	75
6.2 DEFORMATIONS.....	75
6.3 THERMAL CYCLES.....	78
6.4 MONITORING FOR SCOUR.....	78
CHAPTER 7. CONSTRUCTION.....	79
7.1 INTRODUCTION.....	79
7.2 LABOR AND EQUIPMENT.....	80
7.2.1 Labor Requirements.....	80
7.2.2 Tool and Equipment Requirements.....	80
7.3 SITE PREPARATION.....	82
7.3.1 Site Layout.....	82
7.3.2 Excavation.....	82
7.3.3 Placement of Abutment Behind Existing Substructure.....	83
7.4 RSF.....	85
7.5 COMPACTION.....	87
7.5.1 Compaction Procedure.....	88
7.6 REINFORCEMENT.....	88
7.6.1 Operating Equipment on Geosynthetic Reinforcement.....	90
7.6.2 Bearing Reinforcement Bed.....	90
7.6.3 Superelevation.....	91
7.7 WALL FACE.....	91
7.7.1 Leveling Course.....	92
7.7.2 Setting the CMU Block.....	92
7.7.3 Wall Face Alignment.....	92
7.7.4 Block Alignment for Battered Walls.....	93
7.7.5 Superelevation.....	94
7.7.6 Wall Corners.....	95
7.7.7 Top of Facing Wall.....	96
7.8 BEAM SEAT.....	97
7.8.1 Beam Seat Procedure.....	99
7.8.2 Setback.....	100
7.8.3 Aluminum Flashing.....	101
7.8.4 CIP or Precast Footing.....	101
7.9 PLACEMENT OF SUPERSTRUCTURE.....	101
7.9.1 Crane Position on GRS Mass.....	102
7.9.2 Reinforcement of Beam Seat.....	102
7.9.3 Setting Superstructure on Beam Seat (Without CIP Footing).....	102
7.9.4 Wing Walls and Parapets.....	103

7.10 APPROACH INTEGRATION	103
7.10.1 Wrapped Reinforcement Layers on Sides.....	106
7.10.2 Preloading	106
7.10.3 Paving	106
7.10.4 Guardrail Post	107
7.11 SITE DRAINAGE.....	107
CHAPTER 8. IN-SERVICE INSPECTION, MAINTENANCE, AND REPAIR.....	109
8.1 INTRODUCTION.....	109
8.2 IN-SERVICE INSPECTION	109
8.3 MAINTENANCE	110
8.4 REPAIR	111
CHAPTER 9. QUALITY CONTROL AND QUALITY ASSURANCE	115
9.1 INTRODUCTION.....	115
9.2 ROLE OF THE CONTRACTOR	115
9.3 TESTING.....	115
9.3.1 Laboratory Testing.....	115
9.3.2 Field Testing	116
9.4 CONSTRUCTION INSPECTION	116
9.4.1 Materials	116
9.4.2 Equipment.....	117
9.4.3 Project Layout.....	117
9.4.4 Construction Activities	117
9.5 DOCUMENTATION.....	119
9.5.1 Compliance Documentation.....	119
9.5.2 Record Drawings	119
9.6 CONTRACTING METHODS.....	119
9.6.1 Performance Method.....	120
9.6.2 Procedural Method.....	120
9.6.3 Contractor Submittals	122
9.7 PROJECT DRAWINGS AND DOCUMENTS.....	122
APPENDIX A. IN-SERVICE GRADATIONS	123
APPENDIX B. PERFORMANCE TEST PROCEDURE	125
B.1 PERFORMANCE TEST OVERVIEW	125
B.2 PERFORMANCE TEST EXAMPLE: VEGAS MINI-PIER	125
B.3 PERFORMANCE TEST EXAMPLE: DEFIANCE COUNTY	
PERFORMANCE TEST	130
APPENDIX C. LRFD DESIGN PROCEDURE	135
C.1 INTRODUCTION.....	135
C.2 GRS-IBS DESIGN GUIDELINES	136
C.2.1 Step 6—Conduct an External Stability Analysis	137
C.2.2 Step 7—Conduct Internal Stability Analysis	139

C.3 DESIGN EXAMPLE (LRFD): BOWMAN ROAD BRIDGE, DEFIANCE COUNTY, OH	141
C.3.6 Step 6—Conduct an External Stability Analysis	141
C.3.7 Step 7—Conduct Internal Stability Analysis	143
C.3.8 Step 8—Implement Design Details.....	147
APPENDIX D. TYPICAL GRS-IBS WORKING DRAWINGS	149
D.1 SINGLE-PAGE PLAN SHEET	149
D.2 ESTIMATED QUANTITIES AND GENERAL NOTES	150
D.3 PROJECT PLAN AND PROFILE	151
D.4 GRS ABUTMENT DETAILS	152
D.5 SITE PLAN	153
ACKNOWLEDGEMENTS	155
REFERENCES	157

LIST OF FIGURES

Figure 1. Illustration. Typical GRS-IBS cross section	2
Figure 2. Illustration. GRS walls with different facings	15
Figure 3. Photo. Split face CMU blocks	16
Figure 4. Photo. Detail view of split face CMU blocks	16
Figure 5. Photo. Sample of VDOT 21-A gravel	19
Figure 6. Photo. Sample of AASHTO No. 89 gravel	20
Figure 7. Illustration. Geosynthetic roll direction	21
Figure 8. Photo. Bitumen coating on concrete beam ends	23
Figure 9. Chart. Steps for GRS-IBS design	28
Figure 10. Photo. Bridge seat and setback distances	31
Figure 11. Illustration. Clear space distance	32
Figure 12. Illustration. RSF dimensions	33
Figure 13. Illustration. Reinforcement schedule for a GRS abutment	34
Figure 14. Illustration. Vertical and lateral pressures on a GRS abutment	35
Figure 15. Illustration. Boussinesq load distribution with depth for a strip load	37
Figure 16. Illustration. Internal lateral stress in GRS abutment wall due to bridge loading	38
Figure 17. Illustration. External stability: direct sliding	40
Figure 18. Illustration. External stability: bearing capacity	40
Figure 19. Illustration. External stability: global stability	40
Figure 20. Graph. Design envelope for vertical capacity and strain at 8-inch reinforcement spacing	45
Figure 21. Illustration. Lateral deformation of a GRS structure	48
Figure 22. Illustration. Typical cross section of a GRS wing wall	50
Figure 23. Illustration. Typical cross section of a GRS abutment face wall	51
Figure 24. Photo. Guardrail lay-down distance	52
Figure 25. Photo. GRS abutment and wing walls built around core of native soil	52
Figure 26. Illustration. Top view of Bowman Road Bridge showing the bridge, abutments, and wing walls	54
Figure 27. Illustration. Aerial view of the existing site with the planned Bowman Road Bridge superimposed	55
Figure 28. Illustration. Schematic of the west abutment for Bowman Road Bridge	56
Figure 29. Illustration. Schematic of the east abutment for Bowman Road Bridge	56
Figure 30. Illustration. Reinforcement schedule and RSF dimensions for Bowman Road Bridge	59
Figure 31. Screenshot. ReSSA results for global stability for Bowman Road Bridge	63
Figure 32. Graph. Stress-strain curve for Bowman Road Bridge showing ultimate capacity	64
Figure 33. Graph. Vertical strain for Bowman Road Bridge	65
Figure 34. Illustration. Lateral pressure due to the bridge load	68
Figure 35. Illustration. Secondary reinforcement for super-elevation at Bowman Road Bridge	70
Figure 36. Illustration. Typical cross section for sloping rock (adapted)	72
Figure 37. Illustration. Survey level method for superstructure and wall settlement	76
Figure 38. Photo. Location of survey targets on Tiffin River Bridge, Defiance County, OH	77
Figure 39. Photo. Location of total station reference pole	77
Figure 40. Photo. Typical labor crew with centrally located track hoe	80
Figure 41. Photo. Cut slope of retained soil	82

Figure 42. Photo. Horseshoe-shaped excavation with native soil still intact in middle	83
Figure 43. Photo. GRS-IBS built behind an existing concrete abutment	84
Figure 44. Illustration. Cross section of GRS-IBS built behind an existing concrete abutment	84
Figure 45. Photo. Building the RSF behind an existing abutment.....	85
Figure 46. Photo. RSF excavation below stream level	85
Figure 47. Photo. RSF cut preparation.....	86
Figure 48. Photo. Encapsulation of fill in RSF	86
Figure 49. Photo. Placement of wall block on wrapped RSF	87
Figure 50. Illustration. Typical reinforcement zones.....	89
Figure 51. Reinforcement rolled out parallel to wall face	89
Figure 52. Illustration. Superelevation reinforcement schedule	91
Figure 53. Photo. Superelevation reinforcement layers.....	91
Figure 54. Photo. Checking block alignment with string line reference from back of block	93
Figure 55. Photo. Negative batter wall face.....	94
Figure 56. Photo. Blocks trimmed to match superelevation	94
Figure 57. Photo. Right-angle wall corner.....	95
Figure 58. Photo. Vertical seam in wing wall.....	95
Figure 59. Photo. Rebar installed in vertical seam prior to grout	96
Figure 60. Photo. Connecting the top courses of blocks.....	96
Figure 61. Photo. Rounded coping cap.....	97
Figure 62. Photo. Square coping cap	97
Figure 63. Photo. Box beam placed on beam seat	98
Figure 64. Photo. Detail view of box beam placed on beam seat.....	98
Figure 65. Photo. Bearing area block grouted prior to beam placement	98
Figure 66. Photo. Foam board and 4-inch block assembly to form beam seat	99
Figure 67. Photo. 4-inch concrete block on top of foam board against top CMU face block	99
Figure 68. Photo. First 4-inch wrap butted against foam board.....	100
Figure 69. Photo. Top 4-inch wrap butted against 4-inch solid block.....	100
Figure 70. Photo. Aluminum flashing (drip edge) between beams and top of CMU block	101
Figure 71. Photo. Steel girder on CIP footing	101
Figure 72. Photo. Outrigger pads near wall face	102
Figure 73. Photo. Additional reinforcement under beam	102
Figure 74. Photo. Parapet and wing wall construction, view 1.....	103
Figure 75. Photo. Parapet and wing wall construction, view 2.....	103
Figure 76. Photo. Placing reinforcement	104
Figure 77. Photo. First 6-inch fill lift.....	104
Figure 78. Photo. Secondary reinforcement sheet	105
Figure 79. Photo. Completed wrapped approach layer.....	105
Figure 80. Photo. Second 6-inch fill lift	105
Figure 81. Photo. Completed approach fill.....	106
Figure 82. Photo. Use of GRS wall to repair damaged MSE wall.....	111
Figure 83. Photo. CMU GRS wall with a shotcrete face	112
Figure 84. Photo. GRS wall damaged by large sandstone boulder.....	112
Figure 85. Photo. Repair of a GRS wall after damage caused by rock fall	113
Figure 86. Illustration. Plan view of Vegas Mini-Pier Experiment	126
Figure 87. Illustration. Elevation view of Vegas Mini-Pier Experiment.....	126

Figure 88. Photo. Vegas Mini-Pier Experiment reaction base.....	127
Figure 89. Illustration. Side view of Vegas Mini-Pier Experiment	128
Figure 90. Illustration. Face view of Vegas Mini-Pier Experiment.....	128
Figure 91. Photo. Hollow-core hydraulic ram bolted to the top channel beams	129
Figure 92. Graph. Vegas Mini-Pier stress-strain curve.....	130
Figure 93. Illustration. Plan view of Defiance County experiment	130
Figure 94. Illustration. Elevation view of Defiance County experiment.....	131
Figure 95. Photo. Defiance County experiment before testing.....	132
Figure 96. Graph. Defiance County stress-strain curve.....	132
Figure 97. Photo. Defiance County experiment after testing.....	133
Figure 98. Graph. Defiance County stress-strain curve (weaker fabric)	134
Figure 99. Graph. Defiance County experiment comparison	134
Figure 100. Illustration. Single-page plan sheet	149
Figure 101. Illustration. Estimated quantities and general notes	150
Figure 102. Illustration. Project plan and profile.....	151
Figure 103. Illustration. Abutment details	152
Figure 104. Illustration. Site plan	153

LIST OF TABLES

Table 1. GRS abutment well-graded backfill (VDOT 21-A)	18
Table 2. GRS abutment open-graded backfill (AASHTO No. 89).....	19
Table 3. Conformance criteria	22
Table 4. Bearing capacity factors.....	43
Table 5. Foundation and retained backfill soil properties.....	57
Table 6. Road base soil properties	57
Table 7. Reinforced fill properties.....	58
Table 8. Loads and surcharges for Bowman Road Bridge	60
Table 9. Depth of bearing bed reinforcement calculations.....	67
Table 10. Required reinforcement along height of wall	69
Table 11. Defiance County, OH, AASHTO No. 89, clean, crushed limestone.....	123
Table 12. Warren County, OH, AASHTO No. 67, clean, crushed rock.....	123
Table 13. King County, WA, WSDOT 1 ¹ / ₄ -inch minus gravel, clean round rock with sand mixture-pit run.....	123
Table 14. St. Lawrence County, NY, NYSDOT No. 1, clean crushed rock.....	123
Table 15. Urbana, IL, Seismic Test Abutment, IDOT CA6 road base, subrounded gravel with sand mix.....	124
Table 16. Typical load combinations and load factors	135
Table 17. Load factors for permanent loads	136
Table 18. Depth of bearing bed reinforcement calculations (LRFD).....	147

CHAPTER 1. GEOSYNTHETIC REINFORCED SOIL INTEGRATED BRIDGE SYSTEM

1.1. INTRODUCTION

The Geosynthetic Reinforced Soil (GRS) Integrated Bridge System (IBS) provides an economical solution to accelerated bridge construction. Employing this technology will help agencies save both time and money in planning and executing projects. This interim implementation manual and its companion document were developed to assist deployment of this promising technology as part of the Federal Highway Administration's (FHWA) Every Day Counts initiative.⁽¹⁾ The purpose of this manual is to provide a framework for GRS-IBS design and construction that is safe and consistent with the policies and procedures of FHWA and the American Association of State Highway and Transportation Officials (AASHTO), except where the behavior of this technology relieves itself of those requirements.

GRS-IBS was initially developed by FHWA during the Bridge of the Future initiative to help meet the demand for the next generation of small, single span bridges in the United States. GRS-IBS can be built with lower cost, faster construction, and potential improved durability and can be used to build bridges on all types of roads, on or off the National Highway System.

GRS-IBS is a fast, cost-effective method of bridge support that blends the roadway into the superstructure to create a jointless interface between the bridge and the approach (see figure 1). It consists of three main components: the reinforced soil foundation (RSF), the abutment, and the integrated approach. The RSF is composed of granular fill material that is compacted and encapsulated with a geotextile fabric. It provides embedment and increases the bearing width and capacity of the GRS abutment. It also prevents water from infiltrating underneath and into the GRS mass from a river or stream crossing. This method of using geosynthetic fabrics to reinforce foundations is a proven alternative to deep foundations on loose granular soils, soft fine-grained soils, and soft organic soils.⁽²⁾ The abutment uses alternating layers of compacted fill and closely spaced geosynthetic reinforcement to provide support for the bridge, which is placed directly on the GRS abutment without a joint and without cast-in-place (CIP) concrete. GRS is also used to construct an integrated approach to transition to the superstructure. This bridge system therefore alleviates the "bump at the bridge" problem caused by differential settlement between bridge abutments and approach roadways.

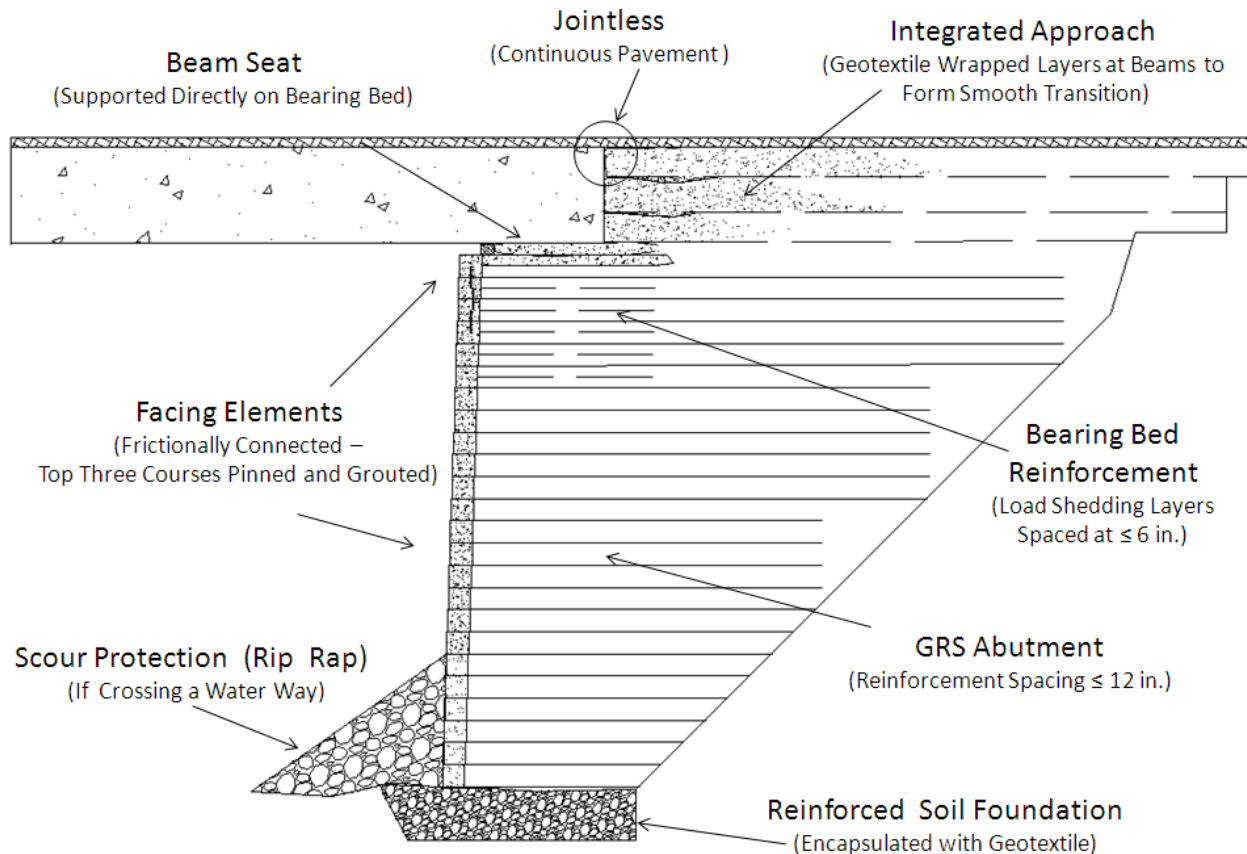

Figure 1. Illustration. Typical GRS-IBS cross section.

The riding surface of GRS-IBS can be maintained as if it is part of the roadway pavement. No special attention to joints or the bridge deck is required. Unlike a traditional integral abutment, IBS is unique in its use of GRS to support the superstructure. This method of accelerated bridge construction is as easy as 1-2-3: (1) a row of facing blocks, (2) a layer of compacted granular fill, and (3) a layer of geosynthetic reinforcement. The 1-2-3 process is repeated until the required abutment height is reached.

GRS-IBS has many other distinct and innovative qualities. GRS technology is extremely durable and can perform well in earthquakes if constructed as outlined in this manual. GRS abutments can be built with readily available material using common construction equipment without the need for highly skilled labor. Construction of the abutment is contained within its footprint for a reduction of environmental impact as well as a reduced work zone. Additional benefits are convenience and design flexibility, as GRS-IBS can be built in variable weather conditions and can be adapted easily in the case of unforeseen site conditions.

This manual addresses the design and construction of GRS-IBS. In-service performance, inspection, maintenance, and repair are also described, along with special requirements for hydraulic and seismic conditions. Finally, procedures for quality assurance (QA) and quality control (QC) (including necessary construction documents) are provided. The ultimate purpose of this manual is to allow designers and contractors to effectively design and construct a durable GRS-IBS.

1.2 BENEFITS OF GRS-IBS

Based on constructed demonstration projects, GRS-IBS is more cost-effective than traditional bridge construction, utilizes common materials and construction techniques, and provides a safer work environment for personnel in work zones.⁽³⁾ GRS-IBS bridges can be built in less time (in weeks, rather than months), which translates into less congestion; fewer road closures, disruptions, and shutdowns around work zones; and lower materials and labor costs. The method of construction is such that the abutments are built from the inside out, reducing the exposure of personnel to potential roadside hazards. In addition, the technology is environmentally sensitive and results in minimal environmental impacts. The technology produces a reduced construction and carbon footprint, eliminates the need for installation of a deep foundation or CIP concrete, and can be adapted to fit the site-specific environmental needs.

The cost to build a GRS-IBS bridge is potentially 25–60 percent less than traditional methods, depending on the standard of construction. The savings is attributable to the simplicity and flexibility of the design, speed of construction (which is less dependent on weather conditions than CIP abutments), use of readily available materials and equipment, and elimination of the deep foundation and other construction details associated with the approach way to the bridge. Furthermore, this method has the potential for reduced maintenance costs because it eliminates the bump at the end of the bridge, creating a smoother and safer transition. Also, the application of GRS technology in other facets of earthwork (e.g., walls, culverts, foundations, slope stability, rock fall barriers, etc.) has the potential to result in significant cost savings and more effective use of transportation funding.

In summary, the benefits of GRS-IBS include the following:

- Reduced construction time.
- 25–30 percent lower cost than standard pile cap abutments on deep foundations with 2:1 slopes for off-system bridges.
- 50–60 percent lower cost than standard department of transportation bridges.
- Construction that is less dependent on weather conditions.
- Flexible design that is easily field-modified for unforeseen site conditions.
- Easier maintenance due to fewer parts.
- Construction with common equipment and materials.
- Better quality control.

CHAPTER 2. NOTATION, ABBREVIATIONS, AND TERMINOLOGY

2.1 NOTATION

α	Angle between wall face and projection of the midline of the surcharge to the wall face [rad]
α_b	Angle between wall face and projection of the midline of the bridge surcharge to the wall face [rad]
β	Angle between the projections of the inner and outer edge lines of the surcharge to the wall face [rad]
β_b	Angle between the projections of the inner and outer edge lines of the bridge surcharge to the wall face [rad]
γ	Unit weight of soil [F/L^3]
γ_b	Unit weight of retained backfill [F/L^3]
$\gamma_{DC\ MAX}$	Maximum load factor for dead load (DL)
$\gamma_{DC\ MIN}$	Minimum load factor for DL
$\gamma_{EH\ MAX}$	Maximum load factor for horizontal earth pressure
$\gamma_{EH\ MIN}$	Minimum load factor for horizontal earth pressure
$\gamma_{ES\ MAX}$	Maximum load factor for earth surcharge
$\gamma_{ES\ MIN}$	Minimum load factor for earth surcharge
$\gamma_{EV\ MAX}$	Maximum load factor for vertical earth pressure
$\gamma_{EV\ MIN}$	Minimum load factor for vertical earth pressure
γ_f	Unit weight of foundation soil [F/L^3]
γ_{LS}	Load factor for live load (LL) surcharge
γ_r	Unit weight of reinforced backfill [F/L^3]
γ_{rb}	Unit weight of road base material [F/L^3]
ϵ_L	Lateral strain
ϵ_V	Vertical strain
μ	Friction factor between the wall base and the foundation
σ_h	Lateral pressure [F/L^2]

$\sigma_{h,f}$	Equivalent lateral stress distribution due to the retained soil behind the GRS abutment [F/L ²]
$\sigma_{h,f}$	Factored lateral pressure [F/L ²]
$\sigma_{h,bridge}$	Lateral pressure due to bridge DL surcharge within GRS [F/L ²]
$\sigma_{h,bridge,eq}$	Lateral pressure due to the equivalent bridge load [F/L ²]
$\sigma_{h,bridge,f}$	Factored lateral pressure due to the equivalent bridge load [F/L ²]
$\sigma_{h,LL}$	Lateral stress distribution due to the equivalent superstructure LL pressure [F/L ²]
$\sigma_{h,q}$	Lateral pressure due to surcharge loading [F/L ²]
$\sigma_{h,rb}$	Lateral pressure due to road base surcharge within GRS [F/L ²]
$\sigma_{h,rb,f}$	Factored lateral pressure due to road base surcharge within GRS [F/L ²]
$\sigma_{h,t}$	Lateral pressure due to traffic surcharge within GRS [F/L ²]
$\sigma_{h,t,f}$	Factored lateral pressure due to traffic surcharge within GRS [F/L ²]
$\sigma_{h,total}$	Total lateral pressure due to loads on GRS mass [F/L ²]
$\sigma_{h,W}$	Lateral stress due to weight of GRS [F/L ²]
$\sigma_{v,base,n}$	Nominal vertical pressure at the base of the GRS mass [F/L ²]
$\sigma_{v,base,R}$	Factored vertical pressure at the base of the GRS mass [F/L ²]
ΣM_D	Total driving moment [L-F/L]
$\Sigma M_{D,R}$	Total factored driving moment [L-F/L]
ΣM_R	Total resisting moment [L-F/L]
$\Sigma M_{R,R}$	Total factored resisting moment [L-F/L]
ΣV	Total vertical load [F/L]
ΣV_R	Total factored vertical load [F/L]
ϕ	Soil friction angle [deg]
ϕ_b	Friction angle of retained backfill [deg]
ϕ_{crit}	Critical friction angle [deg]
ϕ_{design}	Friction angle of reinforced fill used in design [deg]
ϕ_f	Friction angle of foundation soil [deg]
ϕ_r	Friction angle of reinforced backfill [deg]

ϕ_{rb}	Friction angle of road base material [deg]
ϕ_{rep}	Repose angle [deg]
ϕ_{test}	Friction angle of reinforced fill found from standard direct shear test [deg]
Φ_{τ}	Resistance factor for shear resistance
Φ_{bc}	Resistance factor for bearing capacity
Φ_{cap}	Resistance factor for ultimate capacity
Φ_{reinf}	Resistance factor of the required reinforcement strength
ω	Batter angle [deg]
a	Distance between the back of the wall face and a surcharge (setback) [L]
a_b	Setback distance between the back of the face and the beam seat [L]
a_{rb}	Setback distance for the road base surcharge over the GRS mass [L]
a_t	Setback distance for the traffic surcharge over the GRS mass [L]
b	Bearing width for bridge; beam seat [L]
b_{block}	Width of the facing element [L]
b_q	Width of surcharge loading [L]
$b_{q,vol}$	Width of the load along the top of the wall (including the setback) [L]
$b_{rb,t}$	Distance over which the road base DL and roadway LL surcharges act over the GRS mass [L]
B	Base length of reinforcement not including the wall face [L]
B'	Effective foundation width [L]
B_b	Width of the bridge [L]
B_{RSF}	Width of the RSF [L]
B_{total}	Total base width of the GRS abutment including the block face
c	Cohesion [F/L^2]
c_b	Cohesion of retained backfill [F/L^2]
c_f	Cohesion of foundation soil [F/L^2]
c_r	Cohesion of reinforced backfill [F/L^2]
c_u	Undrained shear strength of foundation soil [F/L^2]
d_e	Clear space distance [L]

d_{\max}	Maximum grain size [L]
$D_{50\text{riprap}}$	Mean grain size for riprap
D_f	Depth of embedment [L]
D_L	Maximum lateral displacement [L]
D_V	Vertical settlement in the GRS mass [L]
D_{RSF}	RSF depth [L]
$e_{B,n}$	Nominal eccentricity for bearing capacity calculations [L]
$e_{B,R}$	Factored eccentricity for bearing capacity calculations [L]
F_b	Lateral force due to the retained backfill [F/L]
F_n	Nominal driving force for direct sliding calculations [F/L]
F_{rb}	Lateral force due to the road base surcharge [F/L]
F_R	Factored driving force for direct sliding calculations [F/L]
F_t	Lateral force due to LL on the roadway [F/L]
FS	Factor of safety
FS_{bearing}	Factor of safety against bearing failure
FS_{capacity}	Factor of safety for vertical capacity using the empirical method
FS_{reinf}	Factor of safety for required reinforcement strength
FS_{slide}	Factor of safety against direct sliding
G	Grade [L/L]
h_{eq}	Equivalent height of overburden for traffic surcharge [L]
h_{rb}	Height of road base (equals height of bridge beam) [L]
H	Height of the GRS abutment including the clear space distance [L]
H_{abut}	Height of the GRS abutment [L]
K_a	Coefficient of active earth pressure
K_{ab}	Coefficient of active earth pressure for the retained backfill
K_{ar}	Coefficient of active earth pressure for the reinforced backfill
K_{pr}	Coefficient of passive earth pressure for the reinforced backfill
L_{abut}	Abutment length [L]

L_{block}	Length of a facing block [L]
L_{span}	Span length of the bridge [L]
$(LL + IM)_{\text{total}}$	Governing abutment reaction for the HL-93 LL model for one lane
N_{γ}	Dimensionless bearing capacity coefficient
N_{block}	Number of facing blocks in a column
N_c	Dimensionless bearing capacity coefficient
N_{lanes}	Number of lanes
N_q	Dimensionless bearing capacity coefficient
q	Surcharge load [F/L^2]
q_b	Equivalent superstructure DL pressure [F/L^2]
q_{LL}	Equivalent superstructure LL pressure [F/L^2]
q_n	Bearing capacity of the foundation soil [F/L^2]
$q_{n,\text{an}}$	Nominal ultimate load-carrying capacity of the foundation using the analytical method [F/L^2]
$q_{n,\text{emp}}$	Nominal ultimate load-carrying capacity of the foundation using the empirical method [F/L^2]
q_R	Factored bearing resistance [F/L^2]
q_{rb}	Surcharge due to the structural backfill (road base) DL [F/L^2]
q_t	Equivalent roadway LL surcharge [F/L^2]
$q_{\text{ult},\text{an}}$	Ultimate load-carrying capacity of GRS using the analytical method [F/L^2]
$q_{\text{ult},\text{emp}}$	Ultimate load-carrying capacity of GRS using the empirical method [F/L^2]
Q_{LL}	LL reaction load [F]
R_n	Nominal resisting force for direct sliding calculations [F/L]
R_R	Factored resisting force for direct sliding calculations [F/L]
S_e	Superelevation angle [deg]
S_k	Skew angle [deg]
S_v	Reinforcement spacing [L]
$T_{@ \epsilon = 2\%}$	Reinforcement strength at 2 percent reinforcement strain [F/L]
T_{allow}	Allowable reinforcement strength [F/L]

T_f	Ultimate reinforcement strength [F/L]
$T_{f,f}$	Factored reinforcement strength [F/L]
T_{req}	Required reinforcement strength [F/L]
$T_{req,f}$	Factored required reinforcement strength [F/L]
$V_{allow,an}$	Factored applied stress on top of GRS mass using the analytical method [F/L ²]
$V_{allow,emp}$	Factored applied stress on top of GRS mass using the empirical method [F/L ²]
$V_{applied}$	Applied stress on top of GRS mass [F/L ²]
$V_{applied,f}$	Factored applied stress on top of GRS mass [F/L ²]
W	Weight of the GRS abutment backfill [F/L]
W_B	Total width of riprap [L]
W_{block}	Weight of an individual facing block [F]
W_{face}	Weight of the facing elements [F/L]
W_L	Distance between abutment faces [L]
W_{RSF}	Weight of the RSF [F/L]
W_t	Total weight (weight of GRS plus weight of bridge beam plus weight of the road base over the GRS mass only) [F/L]
$W_{t,R}$	Factored total resisting weight (weight of GRS plus weight of bridge beam plus weight of the road base over the GRS mass only) [F/L]
W_T	Width of level riprap along the top [L]
x	Distance from the edge of the load to the point of interest for lateral pressure [L]
Y_{sc}	Contraction scour plus long-term degradation scour referenced to the thalweg [L]
Y_{Tot}	Distance from the top of riprap to the bottom of riprap [L]
x_{RSF}	Length of the RSF in front of the abutment wall face [L]
z	Location along height of wall (measured from the top of the wall) [L]

2.2 ABBREVIATIONS

AASHTO	American Association of State Highway and Transportation Officials
ASD	Allowable Stress Design
ASTM	American Society for Testing and Materials (known as ASTM International)
CIP	Cast-in-place
CMU	Concrete masonry unit
DL	Dead load
EDM	Electronic distance measurement
FHWA	Federal Highway Administration
GRS	Geosynthetic Reinforced Soil
HEC	Hydraulic Engineering Circular
IBS	Integrated Bridge System
IDOT	Illinois Department of Transportation
LL	Live load
LRFD	Load and Resistance Factor Design
MSE	Mechanically stabilized earth
NCHRP	National Cooperative Highway Research Program
NYSDOT	New York State Department of Transportation
PET	Polyethylene terephthalate (polyester)
PP	Polypropylene
HDPE	High density polyethylene
QA	Quality assurance
QC	Quality control
RSF	Reinforced soil foundation
SPT	Standard penetration test
SRW	Segmental retaining wall
VDOT	Virginia Department of Transportation
WSDOT	Washington State Department of Transportation

2.3 TERMINOLOGY

Biaxial: Reinforcement strength is approximately equal in both the machine and the cross machine directions.

Clear space: The vertical distance between the top of the wall face (block) and base superstructure. Typically, this distance is about 3 inches or at least 2 percent of the wall height.

GRS: Alternating layers of compacted granular fill reinforced with geosynthetic reinforcement (e.g., geotextiles, geogrids). The primary reinforcement spacing in GRS is less than or equal to 12 inches. Facing elements can be frictionally connected to the reinforcement layers to form the outer wall. The facing elements do not need mechanical connections to each other or the layers of reinforcement. The outer wall facing can be built with natural rock, concrete modular block, gabions, timber, or geosynthetic wrapped face. GRS is generic and can be built with any combination of geosynthetic reinforcement, compacted granular fill, and facing system, although some combinations of the three components are more compatible than others.

GRS abutment: A GRS system designed and built to support a bridge. Usually, GRS abutments have three sides: the abutment face wall and two wing walls. All GRS abutments must have the abutment face wall. In some circumstances, depending on the layout, a GRS abutment can be built with one or none of the wing walls.

GRS abutment face wall: The vertical or near vertical wall parallel to the center of bearing and designed to support the bridge. The length of a GRS abutment face wall is typically the total width of the bridge structure plus any additional width necessary to accommodate the structure (e.g., guardrail deflection distance).

GRS-IBS: A unique application of GRS technology in the specific context of bridge abutments. GRS-IBS is different from other, more general GRS abutments that use many common elements associated with traditional bridge abutments. GRS-IBS bridge abutments are built to economically support a bridge on the granular fill directly behind the block face. GRS-IBS can be used to integrate the bridge structure with the bridge approach to create a jointless bridge system. One version of GRS-IBS uses adjacent concrete box beams or void slabs supported directly on the GRS abutments without a concrete footing or elastomeric pads. The bridge has no CIP concrete or approach slab. A typical cross section of IBS shows a GRS mass compacted directly behind the bridge beams to form the approach way and to create a smooth transition from the roadway to the bridge. Another version of GRS-IBS uses steel girders with either a CIP footing or a precast sill. The footing or sill is placed directly on the GRS abutment. The reinforcement layers behind the beam ends are wrapped to confine the compacted approach fill against the beam ends and the adjacent side slopes to prevent lateral spreading. Since the wrapped-face GRS mass behind the beam ends is free standing, the active lateral pressure against the beam ends is considered negligible. The wrapped-face fill also prevents migration of fill during thermal bridge cycles and vehicle LL.

GRS mass or GRS structure: A composite mass built with GRS that creates a freestanding, internally supported structure with reduced lateral earth pressures with considerable strength. This design permits the use of lightweight modular blocks and the elimination of mechanical

connections between blocks and the reinforcement. A GRS mass is not rigid and is therefore tolerant to differential foundation settlement.

GRS wall: Any wall built with GRS.

GRS wing wall: A wall attached and adjacent to the abutment face wall. The wing walls are built at the same time as the abutment face wall and at a right or other angle to the abutment face wall. The wing walls are built to support the roadway and the approach embankment. The wing walls must be designed to retain the soil fill in the core of the approach embankment and to protect the abutment from erosion.

Setback: The lateral distance from the back of the wall face to the front of the bearing area. This distance must be a minimum of 8 inches.

Uniaxial: Reinforcement strength is larger in one direction than the other.

CHAPTER 3. MATERIALS

3.1 INTRODUCTION

Building GRS is as easy as 1-2-3: (1) a row of blocks (the facing elements), (2) a layer of compacted granular fill to the height of the facing blocks, and (3) a layer of geosynthetic reinforcement. The materials used for each step of the process need not be proprietary and are readily available. Recommendations are made to optimize the design based on numerous case histories and field experiments. There are also several miscellaneous materials needed for the details of GRS-IBS.

3.2 FACING ELEMENTS

The facing element is not a structural member of GRS-IBS. Its purpose is to provide a form for compaction, serve as a façade, and protect the granular fill from outside weathering. Since the facing is not a structural element of a GRS mass, it is up to the user to define the type of facing used. It may be made of various materials, including concrete, timber, natural rock, metal, automobile tires, shotcrete, and gabion baskets. While some of the facing elements shown would not be appropriate for use in GRS-IBS bridges, figure 2 shows various facing elements that have been used in the construction of GRS walls.

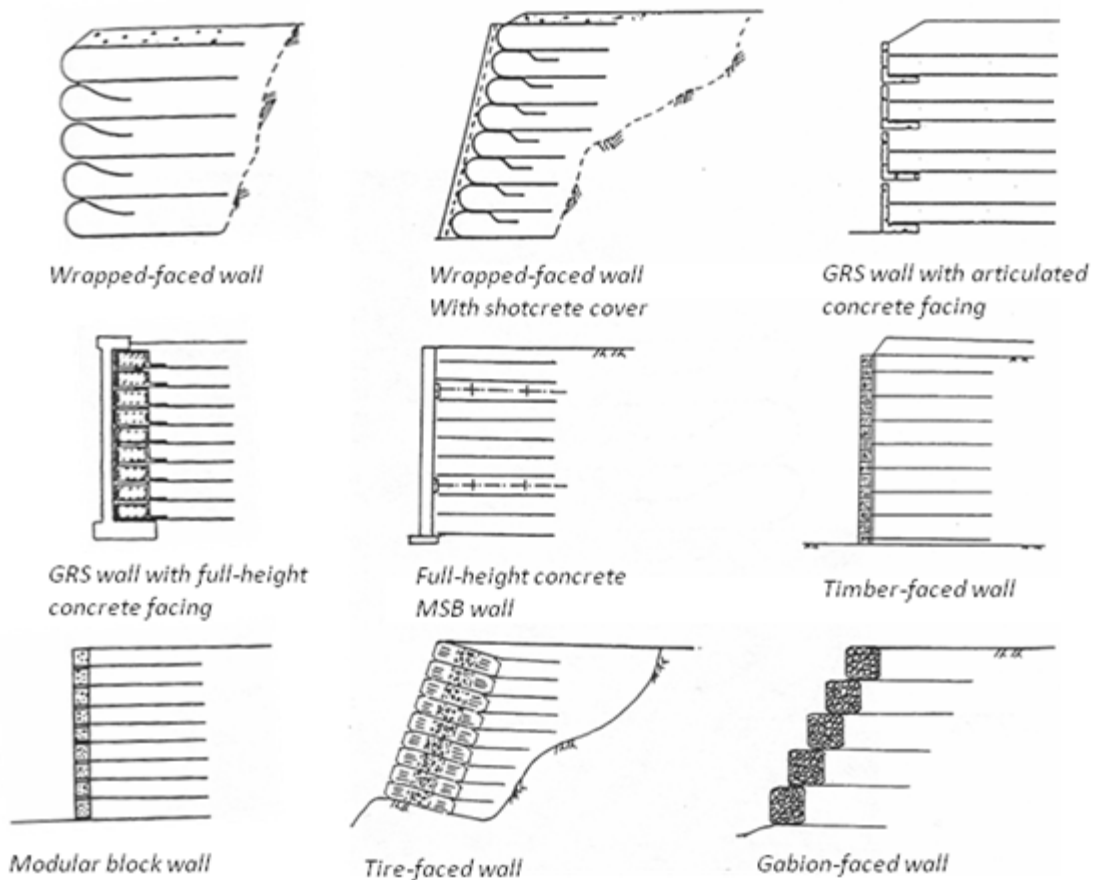

Figure 2. Illustration. GRS walls with different facings.⁽⁴⁾

The most commonly used facing element for GRS walls and abutments is the split face concrete masonry unit (CMU) with nominal dimensions of 8 inches by 8 inches by 16 inches and actual dimensions of $7\frac{5}{8}$ inches by $7\frac{5}{8}$ inches by $15\frac{5}{8}$ inches (see figure 3 and figure 4). It is important to use the actual dimensions in designing and detailing GRS-IBS. CMU blocks are lightweight, easy to place, and ensure compaction at every 8-inch lift before placement of the next geosynthetic layer. As seen in figure 3, the reinforcement extends directly beneath each layer of CMU blocks as a frictional connection.



Figure 3. Photo. Split face CMU blocks.

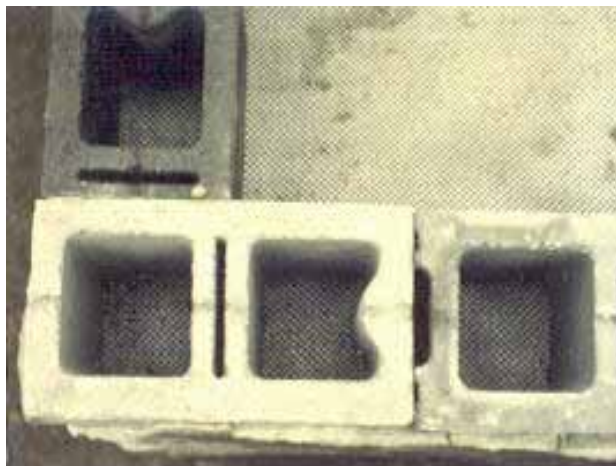

Figure 4. Photo. Detail view of split face CMU blocks.

The CMU should have a minimum compressive strength of 4,000 psi and a water absorption limit of 5 percent. In colder climates, a freeze-thaw test (ASTM C1262-10) should be conducted to assess the durability of the CMU and ensure it follows the standard specification (ASTM C1372). One method to ensure the overall quality of the CMU is to review the QA/QC process of a particular producer.

There are several types of CMU that are commonly used in GRS-IBS construction: solid face, hollow core, and corner block. All of these blocks come in the standard dimensions previously described. In addition to the $7\frac{5}{8}$ -inch height, there are a $3\frac{5}{8}$ -inch solid CMU blocks that can be

used as spacers to form the beam seat (see chapter 7). CMU blocks have been used for GRS construction because they are readily available and inexpensive. They are also compatible with the frictional connection to the recommended reinforcement. Since the facing element is not structural in a GRS wall or abutment, any facing element can be used. With other facing elements, however, special design considerations may apply, and such considerations are beyond the scope of this guide.

3.3 BACKFILL MATERIAL

Backfill selection for GRS-IBS is important because it is a major structural component for the abutment. The backfill must be properly compacted to a minimum of 95 percent of maximum dry density according to AASHTO T-99. Other procedures to determine the degree of compaction can also be used (e.g., modulus-based test methods), as discussed in chapter 7. In GRS-IBS construction, other areas to consider for backfill selections are the RSF and the integrated approach.

Locally sourced aggregates, as long as they meet the material qualifications, are the most economical choice for GRS construction. Most State specifications for aggregate, which are usually met by local quarries and aggregate suppliers, will satisfy the material requirements. Recommendations are provided in this section for GRS abutment, RSF, and approach-way backfills.

It should be noted that some backfill materials are easier to work with than others. Certain backfills are more suitable for compacting behind a given facing element than others. These factors need to be considered when selecting the backfill for a given project.

It has been observed that some fine-grained sands and open-graded coarse aggregates with a maximum grain size greater than 2 inches are difficult to compact directly behind the face of a frictionally connected split face CMU block. The selection of a compatible fill and facing element is therefore necessary for the following purposes:

- Ensure adequate compaction directly behind the face.
- Control face alignment.
- Limit post construction lateral deformation.

3.3.1 GRS Abutment Backfill

Because a GRS abutment is designed to support load, the backfill is considered a structural component. Abutment backfill should consist of crushed, hard, durable particles or fragments of stone or gravel. These materials should be free from organic matter or deleterious material such as shale or other soft particles that have poor durability. The backfill should follow the size and quality requirements for crushed aggregate material normally used locally in the construction and maintenance of highways by Federal or State agencies.

Abutment backfill typically consists of either well-graded or open-graded aggregates (example gradations are shown in sections 3.3.2.1 and 3.3.2.2, respectively). It is recommended that either one of these gradations or a blend in between the two be used as backfill behind GRS abutments. At the time of this report, open-graded aggregates had been selected on all GRS-IBS projects due to the relative ease of construction and favorable drainage characteristics (see appendix A). If the

abutment will be submerged at any point in time, open-graded gravel should be used because it is free-draining. The friction angle of the backfill should be no less than 38 degrees.

Lower quality granular or natural fill materials can be used if the amount of fines is limited to less than 12 percent for drainage. However, a performance test must be conducted (see appendix B) to quantify the deformation and composite behavior of the mass. The engineer should be cautious when using fills of a lower quality than specified, as the allowable load may be significantly reduced. Safety factors for reinforcement strength and ultimate capacity will also deviate from what is specified in design (see chapter 4). It is therefore recommended to follow the abutment backfill specifications outlined in this chapter.

In addition to the gradation requirement, the backfill selection is dependent on the following factors:

- Ability to ensure compaction.
- Drainage (open-graded backfill is recommended for an abutment located in a flood zone to facilitate the flow of water out of the abutment).
- Workability (open-graded fine aggregates (about 0.5 inches) are easier to spread, level, and compact than well-graded fill).
- Angular particles are recommended to maximize the shear strength of the GRS mass.

3.3.1.1 Well-Graded Backfill

Most State transportation department subbase aggregates have a specification for well-graded backfill. A maximum grain size of 2 inches is recommended for efficient compaction behind the abutment wall facing. An example of this type of aggregate is shown in table 1 and in figure 5. The exact gradation is not required. As long as the maximum aggregate size is not exceeded, the amount of fines passing the No. 200 sieve is not greater than 12 percent, and the friction angle is at least 38 degrees, the backfill material will be adequate for GRS-IBS.

Table 1. GRS abutment well-graded backfill (VDOT 21-A).

	U.S. Sieve Size	Percent Passing
Gradation (VDOT 21-A)	2 inch	100
	1 inch	94–100
	³ / ₈ inch	63–72
	No. 10	32–41
	No. 40	14–24
	No. 200	6–12
	Plasticity Index (PI) (AASHTO T-90)	PI ≤ 6
Soundness (AASHTO T-104)	The backfill shall be substantially free of shale or other poor durability particles. The material shall have a magnesium sulfate loss of less than 30 percent after four cycles (or a sodium value less than 15 percent after five cycles).	



Figure 5. Photo. Sample of VDOT 21-A gravel.

3.3.1.2 Open-Graded Backfill

Recommended open-graded backfill material consists of clean, crushed angular (not rounded) stone. The minimum maximum grain size to efficiently achieve compaction behind the abutment wall face is 0.5 inches. An example of a typical open-graded abutment backfill is shown in table 2 and in figure 6. The amount of fines passing the No. 200 sieve should be as close to 0 percent as possible and no more than 5 percent.

Table 2. GRS abutment open-graded backfill (AASHTO No. 89).

	U.S. Sieve Size	Percent Passing
Gradation (AASHTO M-43)	$\frac{1}{2}$ inch	100
	$\frac{3}{8}$ inch	90–100
	No. 4	20–55
	No. 8	5–30
	No. 16	0–10
	No. 50	0–5
Plasticity Index (PI) (AASHTO T-90)	PI \leq 6	
Soundness (AASHTO T-104)	The backfill shall be substantially free of shale or other poor durability particles. The material shall have a magnesium sulfate loss of less than 30 percent after four cycles (or a sodium value less than 15 percent after five cycles).	



Figure 6. Photo. Sample of AASHTO No. 89 gravel.

3.3.2 RSF Backfill

The backfill for the RSF should be well-graded so a dense packing can occur during compaction. The recommended backfill is the same as that used in abutment construction (see table 1).

3.3.2.1 Riprap Protection

Riprap protection should be sized appropriately for the class of stone specified. The stone used should be hard, durable, angular, free of organic and spoil material, and resistant to weathering and water action. It should be free of clay or soft shale seams that can slake when exposed to water. Hydraulic Engineering Circular 23 (HEC-23) should be used to adequately size riprap or other scour countermeasures.⁽⁵⁾

3.3.3 Integrated Approach Backfill

The GRS located directly behind the beam end is necessary to provide a smooth, integrated transition from the approach way to the bridge deck. This area of GRS-IBS is called the approach-way transition. The fill material used for this transition should be a well-graded gravel similar to that used for the RSF backfill (see table 1).

3.4 GEOSYNTHETIC

Since GRS is generic, there are many types of geosynthetic materials of various strengths available for abutment construction. At the time of this report, all in-service GRS-IBSs have used a biaxial, woven polypropylene (PP) geotextile in the abutment. This geotextile was used for several reasons, including cost, ease of placement, and compatibility with the friction connection that is used between the block facing and the GRS mass. While any geosynthetic meeting the requirements outlined in this section can be used in the abutment, a geotextile must be used for the RSF and the integrated approach to encapsulate the material.

An ultimate strength of at least 4,800 lb/ft is used for GRS load-bearing applications. In some cases, it might be appropriate to specify stronger reinforcement strength depending on the design requirements. Chapter 4 provides design guidance on the required reinforcement strength for a particular application, which is a function of the lateral stress, reinforcement spacing, and backfill properties.

The reinforcement strength at 2 percent strain is also an important consideration in the performance of GRS-IBS (see chapter 4). Limiting the required reinforcement strength to less than the reinforcement strength at 2 percent strain will ensure long-term performance and serviceability.

In some situations, the permittivity and apparent opening size of a geosynthetic need to be considered to ensure adequate long-term drainage, particularly when the abutment may be submerged at any point. Since the use of a free-draining backfill is recommended in this situation, a rapid release of water from the reinforced soil fill can occur. Nevertheless, the impact of water on wall design needs to be considered, particularly in situations where rapid drawdown can occur as the result of receding floodwaters. It is also important to ensure that the geosynthetic material is capable within its specific environment.

Geosynthetics can be either uniaxial or biaxial, meaning the reinforcement either has more strength in one direction or it has equal strength in both directions along its length. The term *machine direction* (or warp direction) refers to the strength along the length of the roll, and the term *cross-machine direction* (or fill or weft direction) refers to the strength along the width of the roll (see figure 7). If a uniaxial reinforcement is used, having greater strength in the cross-machine direction allows for easy placement, as the geosynthetic can be rolled out parallel to the wall. When using geosynthetics that are uniaxial in the machine direction, the placement must be perpendicular to the wall, adding to construction time. It is recommended, however, that biaxial reinforcement be used to eliminate construction placement errors and ensure approximately equal strength in both directions.

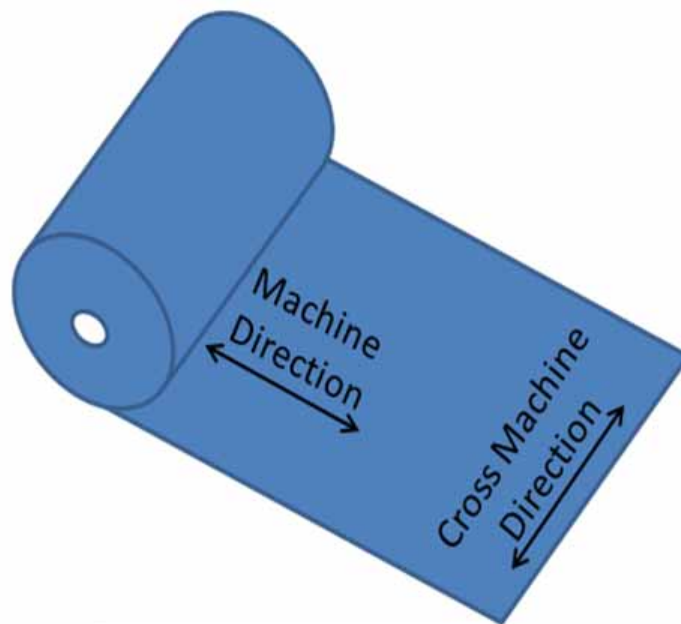

Figure 7. Illustration. Geosynthetic roll direction.

It is important to properly select the geosynthetic for the specific site conditions. The following should be specified for geosynthetic reinforcement:

- Laboratory test results documenting ultimate strength in accordance with ASTM D4595 for geotextiles or ASTM D6637 for geogrids. Tests should be conducted at a strain rate of 10 percent per minute.
- Follow industry standards on the hydrolysis resistance of polyester (PET), oxidative resistance of PP and high density polyethylene (HDPE), and stress cracking resistance of HDPE for all components of the geosynthetic
- Laboratory tests documenting direct sliding coefficients for various soil types or project specific soils in accordance with ASTM D5321.
- Manufacturing QC program and data indicating minimum test requirements, test methods, test frequency, and lot size for each product. Further minimum conformance requirements as prescribed by the manufacturer shall be indicated. Table 3 shows the minimum conformance criteria required for approval.

Table 3. Conformance criteria.

Test	Test Procedure
Wide Width Tensile (geotextiles)	ASTM D4595
Wide Width Tensile (geogrids)	ASTM D6637
Specific Gravity (HDPE only)	ASTM D1505
Melt Flow Index (PP and HDPE)	ASTM D1238
Inherent Viscosity (PET only)	ASTM D4603
Carboxyl End Group (PET only)	ASTM D2455
Single Rib Tensile (geogrids)	ASTM D6637

- The primary resin used in manufacturing shall be identified as to its ASTM type, class, grade, and category.
 - For HDPE resin, type, class, grade, and category in accordance with ASTM D1248 shall be identified. For example: Type III, Class A, Grade E5, Category 5.
 - For PP resins, group, class, and grade in accordance with ASTM D4101 shall be identified. For example: Group 1, Class 1, Grade 4.
 - For PET resins, minimum production inherent viscosity (ASTM D4603) and maximum carboxyl end groups (ASTM D2455) shall be identified.
- For all products, the minimum UV resistance as measured by ASTM D4355 shall be identified.

3.5 MISCELLANEOUS MATERIALS

The three main materials involved in GRS construction are the facing element, the backfill, and the geosynthetic reinforcement. Other miscellaneous materials are also necessary during construction, including the following:

- **Concrete block wall fill:** Concrete block wall fill, along with rebar, is used to fill in and bind together the top three courses of facing blocks (see chapter 7). It is also used for runoff coping and, if necessary, to connect the wing wall to the abutment face when a vertical seam is located at the corners. The concrete used should be ASTM Class A concrete with 4,000 psi compressive strength.
- **Rebar:** No. 4 rebar (0.5-inch diameter), preferably epoxy-coated, is used in the concrete block wall fill to pin the top three courses of facing blocks. If necessary, it can also be used to connect the wing wall to the abutment face at the corners (see chapter 7).
- **Flashing:** Flashing (e.g., aluminum flashing) can be used for two main purposes: (1) to serve as a drip edge under the superstructure within the clear space to shed potentially corrosive fluids off of the dry cast block as a precaution and (2) to prevent animals from burrowing into the abutment (see chapter 7). Typical dimensions of the aluminum fascia are 4 inches by 1.5 inches. This may not be necessary and is a decision left to the engineer.
- **Foam board:** A rigid foam insulation board is used to provide setback and to create a bearing buffer between the superstructure and the wall face (see chapter 7). The foam board is 2-inches thick by 12-inches wide.
- **Bitumen coating:** A bitumen coating is often shop-installed on a concrete beam where it will be embedded within the GRS abutment and wing walls to prevent corrosion of the embedded concrete (see figure 8).



Figure 8. Photo. Bitumen coating on concrete beam ends.

CHAPTER 4. DESIGN METHODOLOGY FOR GRS-IBS

4.1 OVERVIEW OF GRS-IBS DESIGN METHOD

During the past 30 years, GRS technology has been used to build walls, shallow foundations, culverts, bridge abutments, and rock fall barriers. The technology also has been used to stabilize slopes and repair roadways. This chapter focuses on the GRS design method used for GRS-IBS including an abutment and wing walls. While GRS technology can provide solutions in a variety of applications and under certain extreme conditions, the design method described in this manual provides a recipe for design of GRS-IBS with limitations on abutment heights, bridge spans, and design loads.

The design methods described in this chapter are appropriate for GRS structures (an abutment and wing walls) with a vertical or near vertical face and at a height that does not exceed 30 ft. Although the majority of bridges built with GRS-IBS have spans of less than 100 ft, spans of up to 140 ft have been constructed. While larger spans are possible, the bearing stress on the GRS abutment is limited to 4,000 lb/ft². The demands of longer spans on GRS-IBS are not fully understood at this time, and it is recommended that engineers limit bridge spans to approximately 140 ft until further research has been completed.

GRS-IBS abutment capacities are dependent on a combination of the strength of the fill material and the strength of the reinforcement when built in accordance with the two rules of GRS construction: (1) good compaction (95 percent of maximum dry unit weight, according to AASHTO T99) of high-quality granular fill and (2) closely spaced layers of reinforcement (12 inches or less). It is recommended that design or allowable bearing pressure be limited to 4,000 lb/ft².

For design pressures larger than 4,000 lb/ft², the performance criteria must be checked against the applicable stress-strain curve resulting from a performance test (discussed later in this chapter and in appendix B). The performance criteria for GRS-IBS consist of a tolerable vertical strain of 0.5 percent and lateral strain of 1 percent. A significant amount of research and practical experience has shown that GRS-IBS designed and constructed within the limits defined in this manual will produce safe, durable systems.

The design process starts with establishing the project requirements from which the preliminary geometry of GRS-IBS is determined. Once the geometry is defined, it is then evaluated against external and internal modes of failure. An iterative process is used to assess the geometry and make adjustments as necessary to facilitate construction and assure long-term performance. Economy should also be a consideration when evaluating each design alternative (e.g., deeper embedment versus larger footing).

A general and identifying feature of the GRS-IBS design is a mass built with alternating layers of compacted granular fill material and closely spaced reinforcement (less than or equal to 12 inches). In nearly all of the GRS masses built in the United States as full-scale experiments or as in-service structures, however, the design has been based on an 8-inch layered system. There are other features and principles common to a GRS mass. Most GRS walls have been built with dry-stacked concrete facing blocks and are flexible (in terms of global bending stiffness).

A GRS abutment is a type of gravity structure. Therefore, external stability should be evaluated for the direct sliding, bearing capacity, global stability, and overturning failure modes limiting this type of construction. However, because a GRS mass is relatively ductile and free of tensile strength, overturning about the toe, in a strict sense, is not a possible response to earth pressures at the back of the mass or loading on its top. Other attributes of GRS-IBS also tend to preclude overturning as a mode of failure. GRS-IBS consists of two abutments supporting an integrated superstructure that would function as a strut to resist overturning, and each GRS mass has a reinforced integration zone above its heel, also resisting the overturning mode of failure. Consequently, while direct sliding, bearing capacity, and global stability are evaluated in conventional ways, overturning is sometimes addressed by inspection and comparison to observations of past performance.

Observations of past performance show that the flexible, internally stabilized soil mass of GRS-IBS construction, in combination with an RSF, results in more uniform stress distribution, resisting any applied vertical and lateral loads. Observations also show that, in addition to lack of overturning, the combination of vertical and lateral loads, as limited by analysis of direct sliding, bearing capacity, and global stability, does not cause excessive deformation at the face of the GRS mass or other undesirable performance.

While this combination of unique features and behavior eliminates the need to analyze overturning as a failure mode for completed GRS-IBS, the engineer may choose to analyze for overturning during an intermediate phase of construction with consideration for the time needed for an overturning mechanism to develop and the concurrent level of loading or for project configurations different from those described herein. For example, overturning may still be a viable failure mode for abutment wing walls constructed with GRS technology if they retain soil other than reinforced soil from the abutment or opposite wing wall (i.e., if they retain natural soil).

GRS is inherently internally stable because of the interaction between the soil and the reinforcement layers. The strength and stiffness of a GRS mass depends on the unique combination of compacted soil and reinforcement. The vertical capacity of the GRS abutment can be determined either empirically or analytically.

Empirically, the capacity is found using a stress-strain curve specific to the combination of the reinforcement type and granular fill material. If the designer uses a combination of the materials previously tested, then the appropriate stress-strain curve can be used for design. If the designer decides to change the materials from those already tested, then a performance test can be performed to obtain an applicable stress-strain curve for the empirical method. Guidelines on how to conduct a performance test are given in appendix B.

Alternatively, the designer can predict the ultimate vertical capacity of the GRS abutment by using an analytical equation. The equation is a function of reinforcement spacing, soil strength, and soil grain size. Note that the analytical method does not predict vertical deformation. A performance test is needed to adequately predict the deformation behavior of the GRS abutment. This design method is based on the results of many full-scale experiments and verified using case history performance data collected on several in-service GRS structures more than 20 years old.

The design of GRS-IBS is based on the following assumptions:

- The spacing of the reinforcement (12 inches or less) is a principal factor in the performance of GRS-IBS.
- A GRS mass is a composite material that is stabilized internally.
- Both the compacted granular fill and the reinforcement layers strain laterally together in response to vertical stress until the system approaches a failure condition.
- A GRS mass is not supported externally, and therefore, the facing system is not considered a structural element in design.
- Lateral earth pressure at the face of a GRS mass (i.e., thrust) is not significant, eliminating connection failure as a possible limit state.
- The facing elements of a GRS mass are frictionally connected to the geosynthetic reinforcement.
- Under the prescribed granular fill and reinforcement conditions, reinforcement creep is not a concern for the sustained loads. Therefore, individual reduction factors for reinforcement creep are not necessary. Creep can be accommodated safely within the factor of safety used for design.

As described in greater detail in subsequent sections of this manual, GRS-IBS design and construction processes follow from these basic assumptions and principles.

4.2 BASIC DESIGN STEPS FOR GRS-IBS

There are nine basic steps in the design of GRS-IBS (see figure 9). Note that the design philosophy illustrated in this section is Allowable Stress Design (ASD). It is FHWA policy that design for all Federal-aid funded projects be conducted using the AASHTO Load and Resistance Factor Design (LRFD) methodology. Guidelines to design GRS-IBS in an LRFD format are presented in appendix C. The LRFD format presented was normalized to produce the same results as the ASD method and does not represent a statistically based calibration that would be consistent with other AASHTO LRFD methods. After sufficient data is produced and collected as a result of this technology deployment and other efforts, a thorough statistical analysis will be performed to produce LRFD specifications for the design of GRS-IBS.

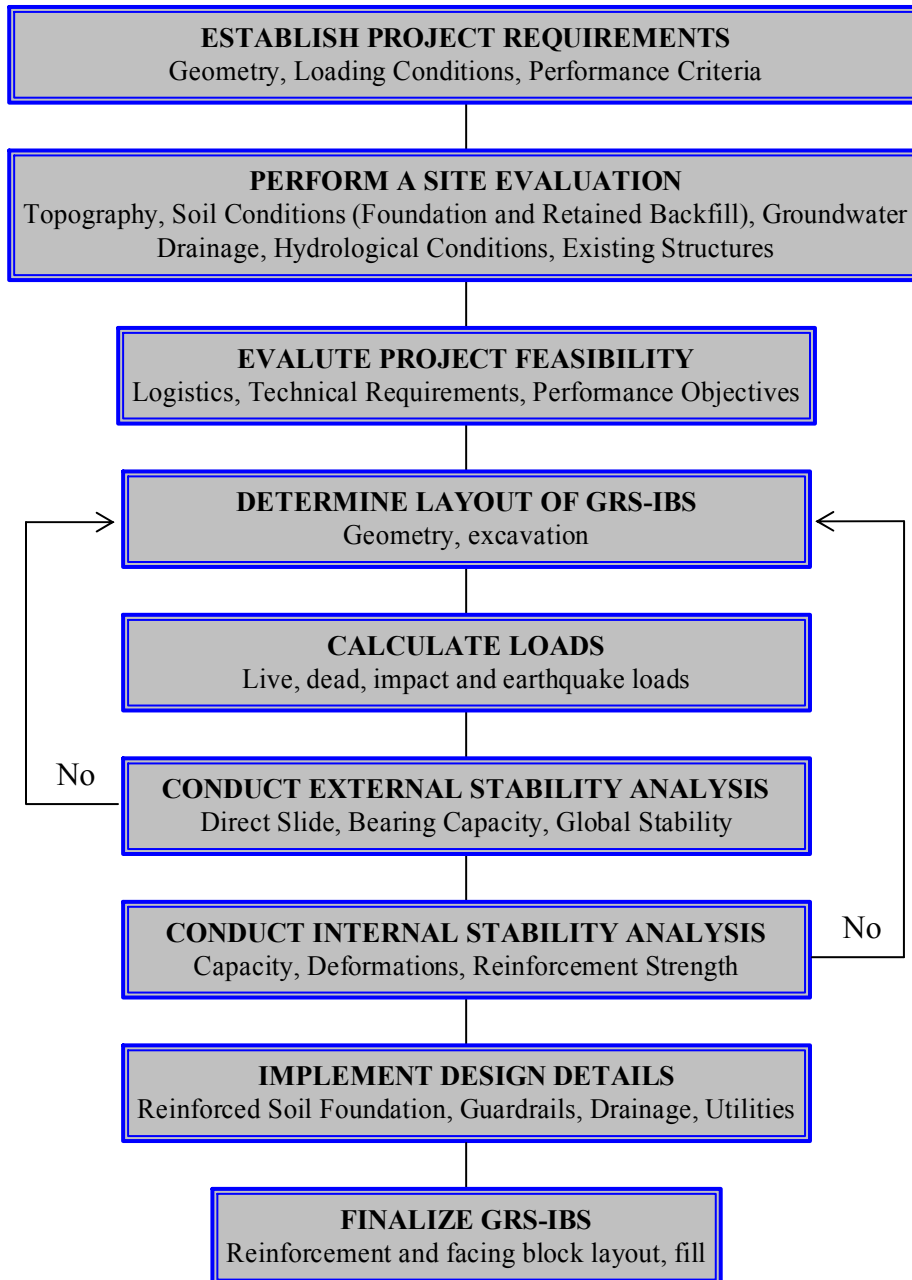

Figure 9. Chart. Steps for GRS-IBS design.

4.3 GRS-IBS DESIGN GUIDELINES

4.3.1 Step 1—Establish Project Requirements

The following parameters must be defined:

- Geometry of abutment and wing walls.
 - Height.

- Length.
- Batter (vertical or near vertical).
- Wall placement with respect to ground conditions: back slope, toe slope.
- Skew.
- Grade.
- Superelevation.
- Loading conditions.
 - Soil surcharge.
 - DL.
 - LL.
 - Seismic load.
 - Impact loads.
 - Loads from adjacent structures.
- Performance criteria.
 - Design format (e.g., ASD, LRFD).
 - Tolerable movements.
 - Vertical settlement.
 - Lateral displacements.
 - Differential settlement.
 - Angular distortion between abutments.
 - Design life.
 - Constraints.
 - Environmental.
 - Construction.

4.3.2 Step 2—Perform a Site Evaluation

To properly assess conditions at the site, a site visit must be conducted. During this visit, the following must be performed by the agency and/or its designer:

- Study the existing topography with respect to the proposed GRS-IBS.
- Check any existing structures/roads for problems to aid in the assessment and design.

- Conduct a subsurface investigation. Refer to AASHTO's *Standard Practice for Conducting Geotechnical Subsurface Investigations* for more information. Alternatively, refer to FHWA's *Soils and Foundations Manual*.^(6,7)
 - Foundation soil properties ($\gamma_f, \phi'_f, C'_f, C_u$).
 - Groundwater conditions.
- Evaluate soil properties for the retained earth ($\gamma_b, \phi_b, C'_b, C_b$).
- Evaluate soil properties for the reinforced backfill ($\gamma_r, \phi_r, C_r, d_{max}$). In addition to the basic soil properties, the maximum diameter of the granular backfill (d_{max}) is necessary to determine the ultimate capacity and required reinforcement strength. The gradation of the reinforced backfill is also important.
- Evaluate hydraulic conditions. This can be accomplished through consultation with a qualified hydrologist.

4.3.3 Step 3—Evaluate Project Feasibility

The feasibility of the project should be evaluated in terms of cost, logistics, technical requirements, and performance objectives. In particular, in the case of abutments for bridges constructed over water, the potential for scour, sedimentation, and/or channel instability must be evaluated in accordance with the policy and procedures of both FHWA and AASHTO. It is necessary to determine the potential for scour at all bridges constructed over water. If the abutment will be impacted by scour, additional design requirements are necessary (see chapter 6). These additional design requirements can be determined and implemented through a hydraulic and scour analysis of the site. Once the scour potential is determined, a countermeasure can be designed to protect the abutment against failure during a flood due to the scour that will occur at the toe of the abutment. A designed countermeasure will also protect the abutment from lateral channel migration that could undermine the foundation.

4.3.4 Step 4—Determine Layout of GRS-IBS

The layout of GRS-IBS is ultimately based on site conditions (e.g., desired road alignment, right of way, geotechnical issues, and hydraulic considerations). A survey should be conducted to determine the location of the GRS abutment and the layout. The layout of the abutment face wall needs to coincide with the wing walls because the system is built from the bottom up one course at a time. Both walls are built at the same time. Use the following steps to design the abutment:

1. Define the geometry of the abutment face wall and wing walls.
2. Layout the abutment with respect to the superstructure (skew, superelevation, grade).
 - The recommended minimum bearing width (b) for the superstructure is 2.5 ft for span lengths (L_{span}) greater than or equal to 25 ft, as shown in figure 10. For span lengths (L_{span}) less than 25 ft, the minimum bearing width is 2.0 ft.

3. Account for setback and clear space to calculate the elevation of the abutment face wall and the span length of the bridge.
- The setback distance (a_b) between the back of the face and the beam seat should be the height of a standard CMU (nominally 8 inches) or more, as shown in figure 10.
 - The minimum clear space (d_e), defined as the distance from the top of the uppermost facing block to the bottom of the superstructure, should be 3 inches or 2 percent of the abutment height, whichever is greater (see figure 11). The gap is to ensure that the superstructure does not bear on the facing block due to an unforeseen event.

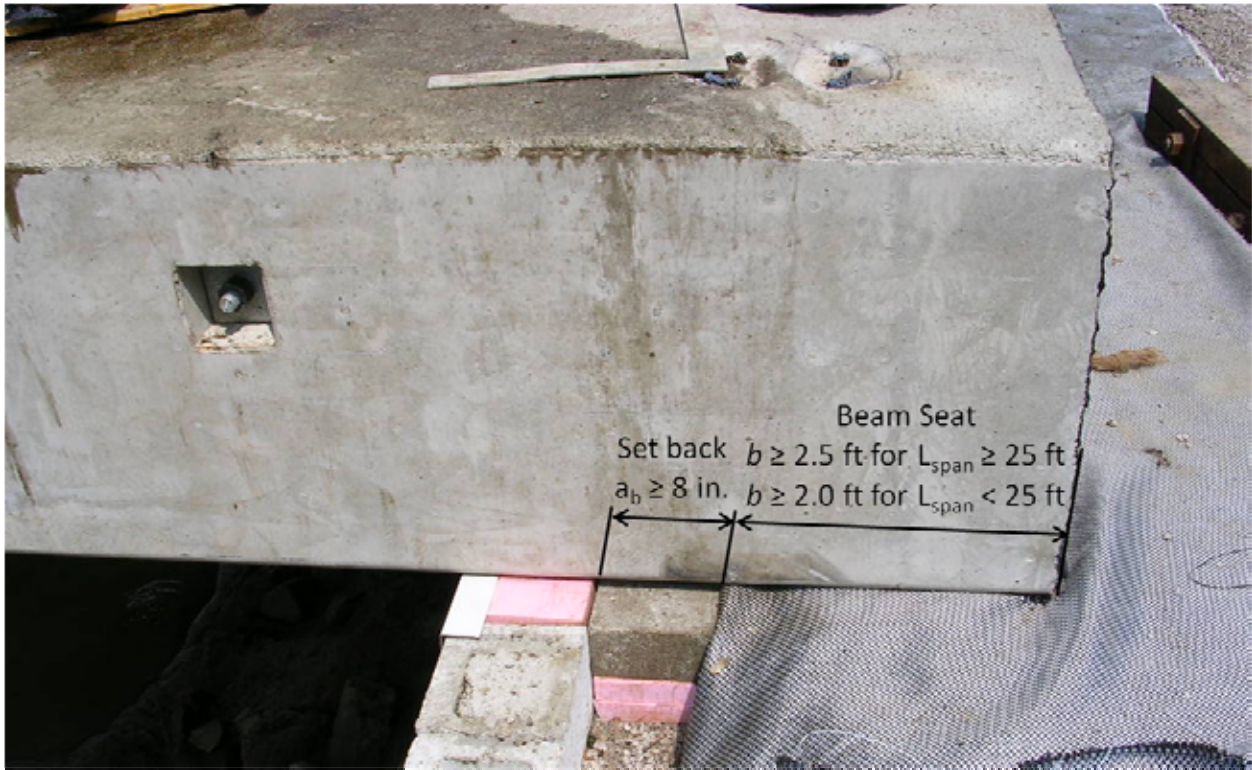

Figure 10. Photo. Bridge seat and setback distances.

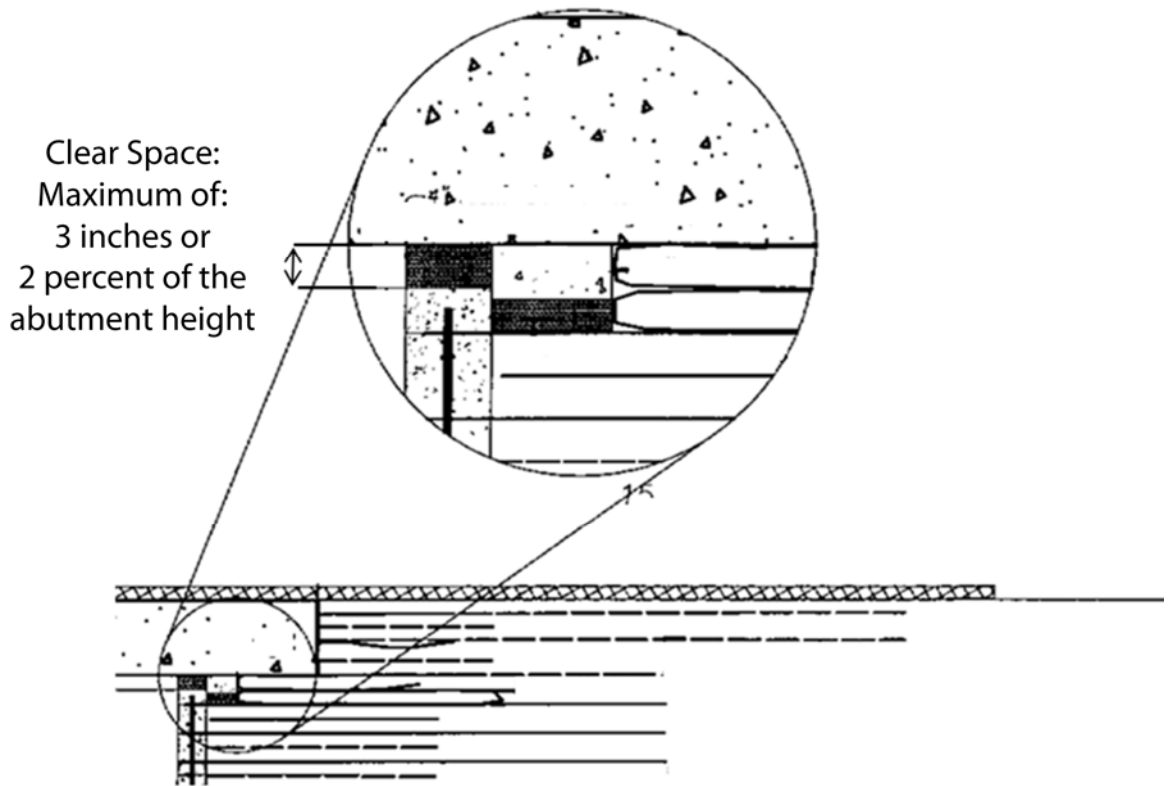

Figure 11. Illustration. Clear space distance.

4. Determine the depth and volume of excavation necessary for construction. A GRS abutment is inherently stable and therefore can be built with a truncated base to reduce the excavation. Truncation also reduces the requirements for backfill and reinforcement.
 - For span lengths (L_{span}) greater than or equal to 25 ft, a minimum base width of the wall including the block face (B_{total}) of 6 ft should initially be chosen. For span lengths (L_{span}) less than 25 ft, a minimum base width of the wall including the block face (B_{total}) of 5 ft should initially be chosen. Whether a cut or fill situation, there should be a minimum base-to-height (B_{total}/H) ratio of 0.3. If GRS-IBS is to cross water, the base of the abutment should be placed at the calculated scour depth (see chapter 5).
 - Excavation of one-quarter the total width of the base of the abutment including the block face should be made at the base in front of the face of the wall to accommodate for construction of the RSF. The total width of the RSF should extend beyond the base of the GRS abutment by one-fourth the width of the base (see figure 12).
 - The depth of the excavation for the RSF (D_{RSF}) should equal one-quarter the total width of the base of the GRS abutment including the block face (see figure 12). Additional excavation may be necessary depending on the soil conditions (e.g., compressible soils) and should be determined by the engineer.

In some situations, it may be beneficial to improve the ground beneath the RSF to reduce settlement of the bridge system.

- Before designing and constructing an RSF, it is prudent to conduct a soil investigation of the existing foundation soil including applicable lab tests to determine the soil's properties, as discussed in section 4.3.2.

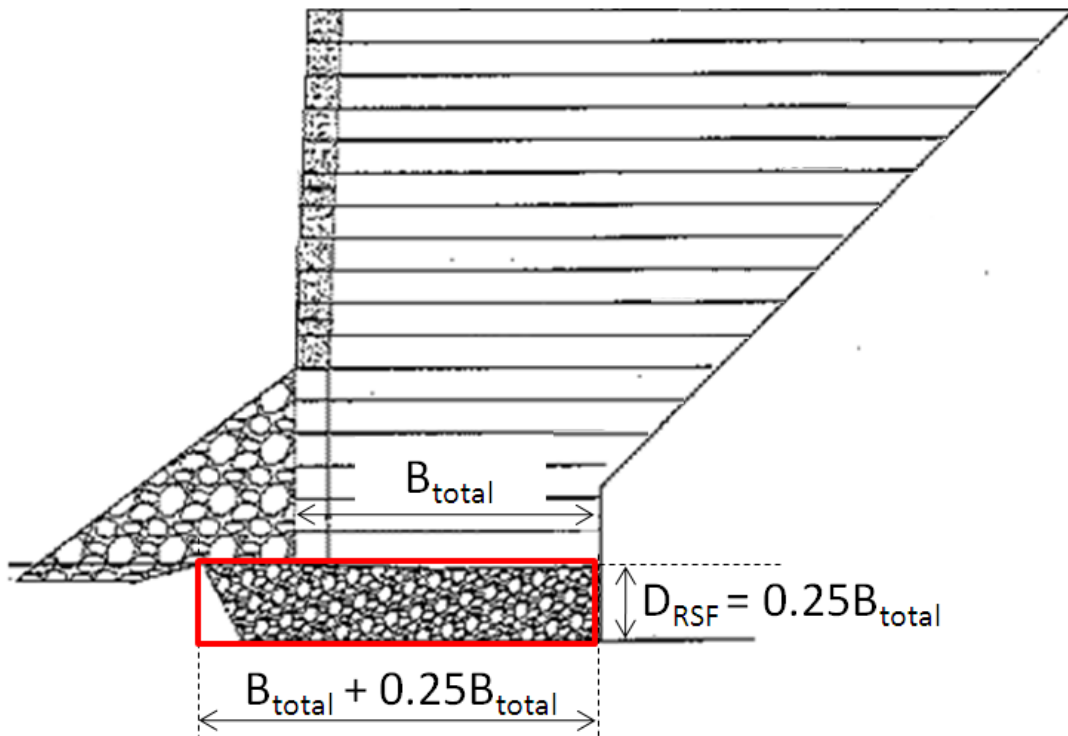

Figure 12. Illustration. RSF dimensions.

5. Select the length of reinforcement for the abutment. The minimum reinforcement length at the lowest level should extend the width of the base (B_{total}) and have a minimum base-to-height ratio (B/H) (not including the facing block) of 0.3. The minimum reinforcement length at the lowest level should extend the width of the base (B_{total}), with a minimum of 5–6 ft or a base-to-height ratio (B/H) of 0.3 (see previous step). Once the base length of the reinforcement is chosen, the reinforcement schedule should follow the cut slope, if applicable, up to a B/H ratio of 0.7. From there, the reinforcement length can get progressively longer in reinforcement zones (see figure 13). Not every layer will need to extend fully to the cut slope. The progressively longer lengths of reinforcement serve to improve the quality of construction and overall stability of the GRS abutment. The reinforcement zones also serve to provide a transition from the substructure to the superstructure. The exact details of the reinforcement zones, such as number of layers and length, are left to the designer. For cut slopes flatter than 1:1, reinforcement zones with lengths larger than 1H may not be necessary. The backfill between the reinforced zone and the cut slope or retained soil must be the same structural backfill as the reinforced fill and compacted to the same effort (see chapter 3). The reinforcement spacing should be no more than 12 inches at the wall face, in accordance with the two rules of GRS construction.

6. Add a bearing reinforcement zone underneath the bridge seat to support the increased loads due to the bridge (see figure 13). This bearing bed reinforcement serves as an embedded footing in the reinforced soil mass. The bearing bed reinforcement spacing directly underneath the beam seat should be, at a minimum, half the primary spacing (e.g., for an 8-inch primary spacing, the bearing bed reinforcement spacing will equal 4 inches). In general, the minimum length of the bearing bed reinforcement should be twice the setback plus the width of the bridge seat. The depth of the bearing reinforcement zone is determined based on internal stability design for required reinforcement strength (see section 4.4.7.3.1). At a minimum, there should be five bearing bed reinforcement layers (see figure 13).

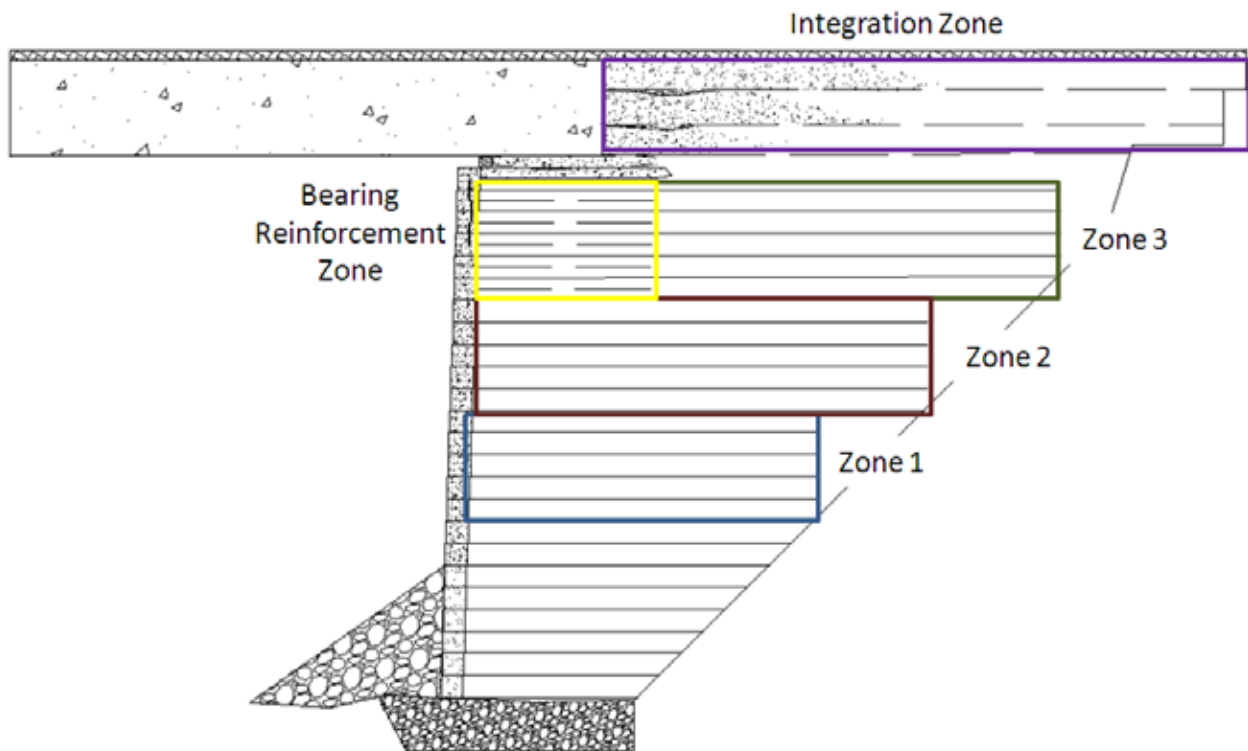

Figure 13. Illustration. Reinforcement schedule for a GRS abutment.

7. Blend the reinforcement layers in the integration zone to create a smooth transition. The layers should extend to the cut slope, if applicable, with the exception of the top reinforcement layer, depending on the site. This top layer should extend beyond the cut slope to prevent moisture infiltration. The integration zone is part of the integrated approach of GRS-IBS (see figure 13). It is added behind the bridge superstructure to limit the development of a tension crack at the cut slope and reinforced soil interface and to blend the approach way on to the roadway to create a smooth transition. The number of reinforcement layers in the integration zone depends on the height of the superstructure, but each wrapped layer should be no more than 12 inches in height. Additional work is needed to integrate the substructure with the superstructure within the integration zone. This is described in chapter 7.

4.3.5 Step 5—Calculate Applicable Loads

The applicable external pressures and loads (permanent and transient) on the reinforced zone of the GRS abutment should be calculated. The most common pressures (which may be resolved into forces) on GRS-IBS for stability computations are depicted in figure 14.

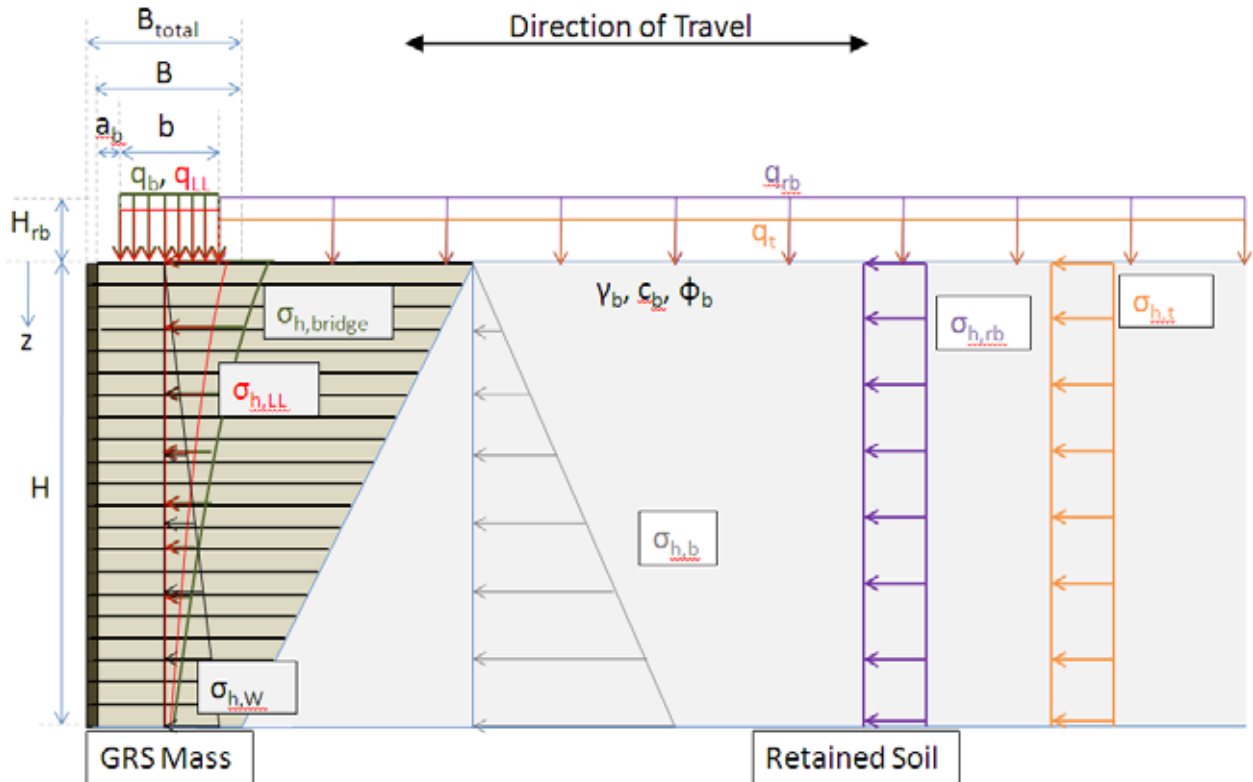

Figure 14. Illustration. Vertical and lateral pressures on a GRS abutment.

The applicable pressures on a GRS abutment are as follows:

- q_t = equivalent roadway LL surcharge
- $\sigma_{h,t}$ = lateral stress distribution due to the equivalent roadway LL surcharge
- q_{rb} = surcharge due to the structural backfill of the integrated approach (road base)
- $\sigma_{h,rb}$ = lateral stress distribution due to the structural backfill of the integrated approach
- q_b = equivalent superstructure DL pressure
- $\sigma_{h,bridge}$ = lateral stress distribution due to the equivalent superstructure DL pressure
- $\sigma_{h,b}$ = equivalent lateral stress distribution due to retained soil behind the GRS abutment
- q_{LL} = equivalent superstructure LL pressure

- $\sigma_{h,LL}$ = lateral stress distribution due to the equivalent superstructure LL pressure
- $\sigma_{h,W}$ = lateral stress distribution due to the weight of the GRS fill

4.3.5.1 Lateral Pressures and Stresses

The lateral earth pressure can be calculated according to classical soil mechanics for active earth pressure. The active earth pressure coefficient (K_a) is calculated according to equation 1.

$$K_a = \frac{1 - \sin \phi}{1 + \sin \phi} = \tan^2 \left(45^\circ - \frac{\phi}{2} \right) \quad (1)$$

Where ϕ is the friction angle of interest (for example, substitute ϕ_b when calculating K_{ab} for the retained soil). The lateral stress distribution due to the weight of the GRS fill ($\sigma_{h,W}$) is found using Rankine's active stress condition, shown in equation 2.

$$\sigma_{h,W} = \gamma_r z K_{ar} \quad (2)$$

Where γ_r is the unit weight of the reinforced fill, z is the depth from the top of the wall, and K_{ar} is the coefficient of active earth pressure (equation 1) using the friction angle of the reinforced fill (ϕ_r).

The lateral stress distributions due to the equivalent roadway LL surcharge ($\sigma_{h,t}$) and structural backfill of the integrated approach ($\sigma_{h,rb}$) are found according to equation 3 and equation 4, respectively.

$$\sigma_{h,t} = q_t K_{ab} \quad (3)$$

$$\sigma_{h,rb} = q_{rb} K_{ab} \quad (4)$$

Where q_t is the equivalent roadway LL surcharge, q_{rb} is the surcharge due to structural backfill (road base), and K_{ab} is the coefficient of active earth pressure (equation 1) using the friction angle of the retained backfill (ϕ_b). Note that equation 3 and equation 4 assume that the loading is continuous across the retained soil.

Where the loads are not continuous across the GRS abutment or retained soil, the lateral pressure is based on Boussinesq theory for load distribution through a soil mass for an area transmitting a uniform stress a distance x from the edge of the load (see figure 15).⁽⁸⁾ The actual pressure using this theory depends on the location of interest. For required reinforcement strength calculations, the location of interest is directly underneath the beam seat centerline (e.g., $x = b_q/2$ for the bridge DL).

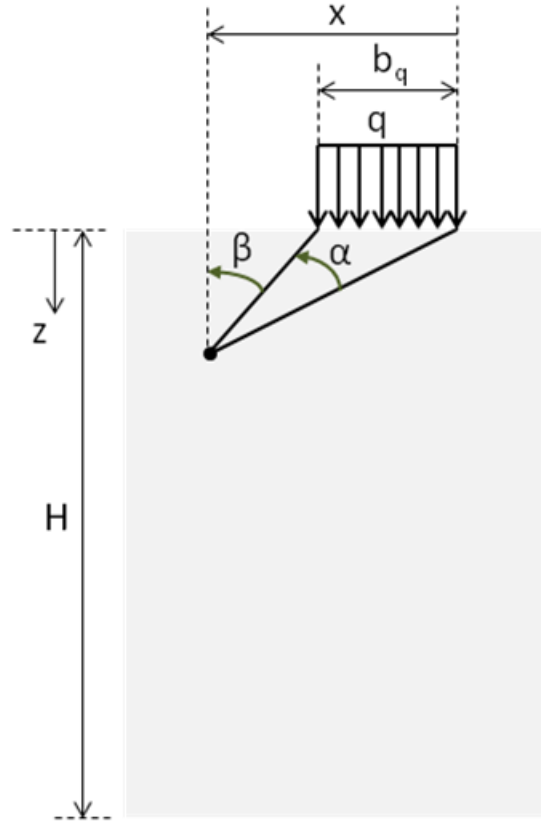

Figure 15. Illustration. Boussinesq load distribution with depth for a strip load.

The lateral pressure due to surcharge loading ($\sigma_{h,q}$) is calculated according to equation 5.

$$\sigma_{h,q} = \frac{q}{\pi} [\alpha + \sin(\alpha) \cos(\alpha + 2\beta)] K_a \quad (5)$$

Where q is the surcharge pressure (e.g., q_b for the bridge surcharge), K_a is the coefficient of active earth pressure (equation 1), and α and β are the angles shown in figure 15, found using equation 6 and equation 7, respectively. Note that α and β must be input in radians in equation 5.

$$\alpha = \tan^{-1} \left(\frac{x}{z} \right) - \beta \quad (6)$$

$$\beta = \tan^{-1} \left(\frac{x - b_q}{z} \right) \quad (7)$$

The lateral pressure in the GRS abutment due to the superstructure DL and LL will have a trend similar to that shown in figure 16, where the stress is highest at the top of the GRS abutment and lowest at the base. Note that the bearing bed reinforcement underneath the beam seat helps to mitigate the increased vertical (and thus lateral) pressures in this location. In fact, the bearing bed reinforcement is recommended in the design of GRS abutments for this reason.

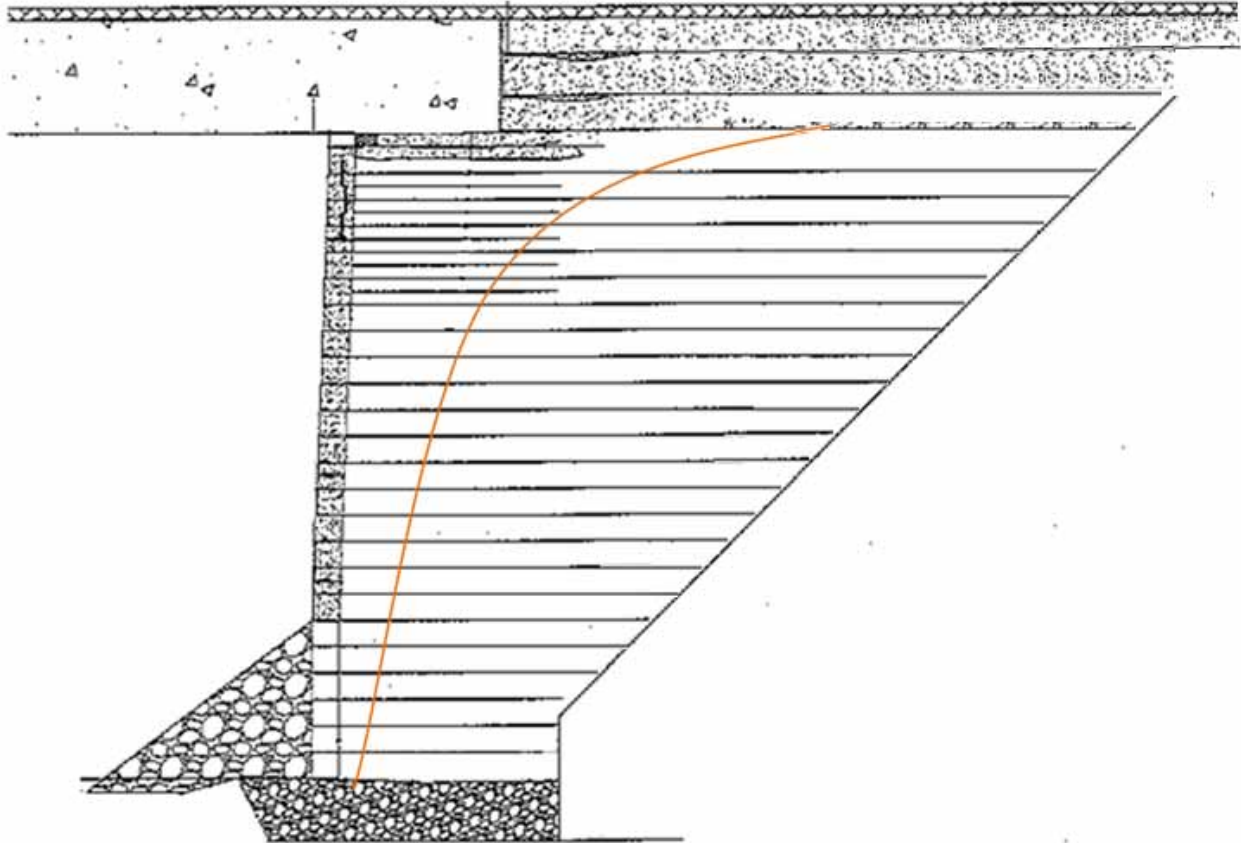

Figure 16. Illustration. Internal lateral stress in GRS abutment wall due to bridge loading.

Note that other load distributions are available besides Boussinesq. For example Westergaard is more applicable to a GRS mass than Boussinesq. However, it gives lower stresses than Boussinesq, and therefore, using Boussinesq will provide a more conservative estimate of stresses.

4.3.5.2 Dead Loads

4.3.5.2.1 Bridge: In a GRS-IBS design with adjacent concrete box beams, the bridge superstructure bears directly upon the GRS abutment. For superstructures with spread girders, a footing (which bears directly upon the GRS abutment) is necessary to ensure even load distribution on the GRS abutment. The equivalent DL design pressure on the abutment seat includes the dead loads due to the bridge beams, asphalt, overlay, guardrail, and any other applicable permanent loads related to the superstructure.

4.3.5.2.2 Road Base: Behind the bridge beams, road base is wrapped in geotextile (called the integrated approach). The wrapped face controls lateral load from the road base on the beam or abutment sill.

4.3.5.3 Live Loads

There are two applications of LL that affect the design of GRS-IBS: LL on the approach pavement and LL on the superstructure. Both of these live loads are defined by AASHTO and should be appropriately quantified by the design engineer.⁽⁹⁾

4.3.5.3.1 LL on the Approach Pavement: An LL surcharge (q_l) is used to account for the vehicular load on the approach pavement leading up to the superstructure. This load consists of a uniform height (h_{eq}) of earth that produces an equivalent lateral effect on the abutment as the application of the vehicular LL specified for the superstructure. The equivalent height of earth is dependent on the abutment height and the orientation of the abutment with respect to the roadway (e.g., perpendicular). This load is used for both internal and external stability analyses.

4.3.5.3.2 LL on the Superstructure: The vehicular LL used for designing GRS-IBS is determined by applying the HL-93 LL model to the superstructure. This model consists of appropriately locating a design truck or design tandem in combination with a design lane load in each design lane of the bridge to create the maximum force effect at each abutment. The vehicular portion of the LL model is amplified for dynamic load allowance (impact). The governing LL is distributed to the abutment by multiplying by the number of design lanes and dividing by the bridge seat bearing area. This equivalent distributed LL pressure on the abutment seat (q_{LL}) can be determined using equation 8.

$$q_{LL} = \frac{(LL + IM)_{total} (N_{lanes})}{b(B_b)} \quad (8)$$

Where N_{lanes} is the number of design lanes on the bridge, b is the bridge seat bearing width (see figure 14), B_b is the width of the bridge, and $(LL+IM)_{total}$ is the governing abutment reaction for the HL-93 LL model for one lane.

If the bridge seat bearing width is unknown and needs sizing, the LL from the superstructure should be quantified as a reaction (Q_{LL}) rather than a pressure (see equation 9).

$$Q_{LL} = (LL + IM)_{total} (N_{lanes}) \quad (9)$$

4.3.5.4 Design Pressure

Adding LL on the superstructure and bridge DL per abutment will give the total load that the bridge seat must support. Dividing this total load by the area of the bridge seat will give the bearing pressure. For abutment applications, the bearing pressure should be targeted to around 4,000 lbs/ft². If this is exceeded, the width of the bridge seat should be increased. Although higher design pressures have been successfully applied to in-service GRS-IBS, this is not encouraged.⁽¹⁾

4.3.6 Step 6—Conduct an External Stability Analysis

The external stability of GRS-IBS is evaluated by looking at the following potential external failure mechanisms:

- Direct sliding (shown in figure 17).
- Bearing capacity (shown in figure 18)
- Global stability (shown in figure 19).

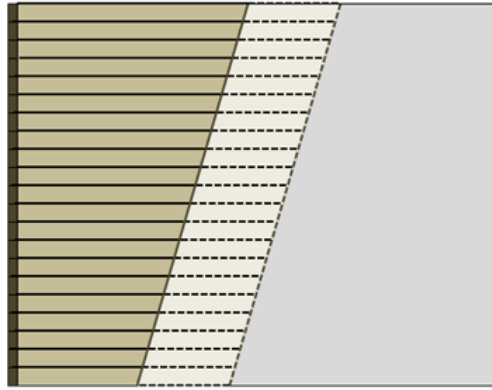

Figure 17. Illustration. External stability: direct sliding.

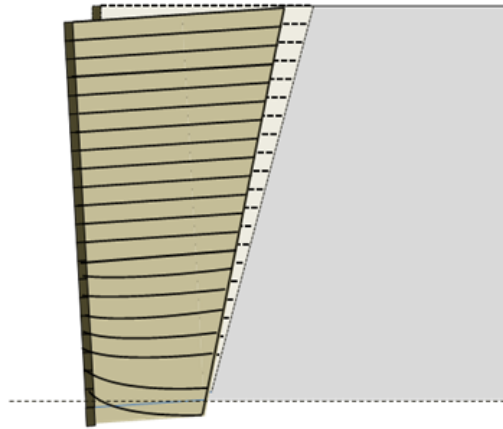

Figure 18. Illustration. External stability: bearing capacity.

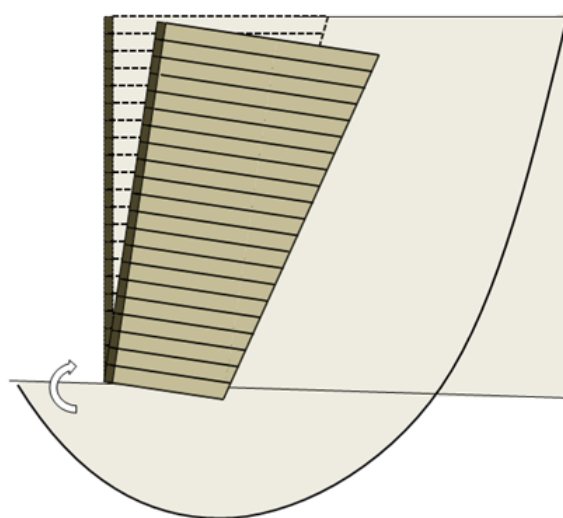

Figure 19. Illustration. External stability: global stability.

4.3.6.1 Direct Sliding

The GRS abutment must resist translation, or direct sliding. The LL on the approach pavement (q_t) is assumed to act only over the retained backfill and not the reinforced soil mass. While the contribution of q_t (and q_{LL}) is ignored for both a wall and an abutment, the bridge load (q_b) has a stabilization effect against direct sliding when considering an abutment. Since the road base extends over the GRS abutment and the retained backfill, it acts to both stabilize and drive direct sliding. Contributions to both the driving force and to the resisting force from the road base must be taken into account because it is a permanent load.

The thrust forces behind the GRS abutment from the retained backfill (F_b), the road base (F_{rb}), and the roadway LL surcharge (F_t) are calculated using equation 10, equation 11, and equation 12.

$$F_b = \frac{1}{2} \gamma_b K_{ab} H^2 \quad (10)$$

$$F_{rb} = q_{rb} K_{ab} H \quad (11)$$

$$F_t = q_t K_{ab} H \quad (12)$$

Where γ_b is the unit weight of the retained backfill, K_{ab} is the active earth pressure coefficient for the retained backfill (equation 1), H is the height of the wall including the clear space distance, q_{rb} is the road base DL, and q_t is the roadway LL.

The total driving force (F_n) is calculated by summing each thrust force previously calculated, as shown in equation 13.

$$F_n = F_b + F_{rb} + F_t \quad (13)$$

The resisting force (R_n) is calculated according to equation 14.

$$R_n = W_t \mu \quad (14)$$

Where W_t is the total resisting weight (calculated in equation 15), μ is the friction factor between the wall base and the foundation (taken as $\tan \phi_{crit}$), and ϕ_{crit} is the critical friction angle. Since the RSF is encapsulated with geotextile, sliding at the base of the GRS abutment will occur between soil and the geotextile reinforcement. The critical friction angle will therefore be the interface friction angle between the soil and reinforcement. The interface friction angle should be determined with an interface direct shear test for the particular combination of geosynthetic and reinforced fill material (ASTM D5321). If this information is not available for geotextiles and geogrids, assume that the friction factor is equal to $^{2/3}$ times the tangent of the reinforced granular fill friction angle ($\mu = ^{2/3} \tan(\phi_r)$).

$$W_t = W + q_b b + q_{rb} b_{rb,t} \quad (15)$$

Where W is the weight of the GRS abutment (calculated in equation 16), q_b is the bridge DL, b is the width of the bridge load (measured along the direction of the roadway), q_{rb} is the road base

DL, and $b_{rb,t}$ is the width over the GRS abutment where the road base DL acts (see figure 14). The LL on the approach pavement and the superstructure are not included as resisting forces because they are transient loads.

$$W = \gamma_r HB \quad (16)$$

Where γ_r is the unit weight of the reinforced fill, H is the height of the GRS abutment including the clear space distance, and B is the base width of the GRS abutment not including the wall facing.

The factor of safety against direct sliding (FS_{slide}) is computed according to equation 17. The factor of safety must be greater than or equal to 1.5. If not, consider lengthening the reinforcement at the base.

$$FS_{slide} = \frac{R_n}{F_n} \geq 1.5 \quad (17)$$

4.3.6.2 Bearing Capacity

To prevent bearing failure, the vertical pressure at the base of the RSF must not exceed the allowable bearing capacity of the underlying soil foundation. The vertical pressure is a result of the weight of the GRS abutment, the weight of the RSF, the bridge seat load, the LL on the superstructure, and the LL on the approach pavement. The pressure at the base ($\sigma_{v,base,n}$) is calculated according to a Meyerhof-type distribution, shown in equation 18.⁽¹⁰⁾

$$\sigma_{v,base,n} = \frac{\Sigma V}{B_{RSF} - 2e_{B,n}} \quad (18)$$

Where ΣV is the total vertical load on the GRS abutment (calculated in equation 19), B_{RSF} is the width of the RSF, and $e_{B,n}$ is the eccentricity of the resulting force at the base of the wall (calculated in equation 20).

$$\Sigma V = W + W_{RSF} + W_{face} + b_{rb,t}(q_t + q_{rb}) + b(q_b + q_{LL}) \quad (19)$$

Where W is the weight of the GRS abutment (equation 16), W_{RSF} is the weight of the RSF, W_{face} is the weight of the facing elements, q_t is the roadway LL, $b_{rb,t}$ is the width of the traffic and road base load over the GRS abutment, q_{rb} is the road base surcharge, q_b is the bridge DL, b is the width of the bridge seat, and q_{LL} is the LL on the superstructure.

$$e_{B,n} = \frac{\Sigma M_D - \Sigma M_R}{\Sigma V} \quad (20)$$

Where ΣM_D is the total driving moment, ΣM_R is the total resisting moment, and ΣV is the total vertical load (equation 19). The moments should be calculated about the bottom and center of the RSF for the specific layout of the GRS abutment. If $e_{B,n}$ is negative, take $e_{B,n}$ equal to zero for the term $B_{RSF} - 2e_{B,n}$.

The bearing capacity of the foundation (q_n) can be found using equation 21.⁽⁹⁾

$$q_n = c_f N_c + \frac{1}{2} B' \gamma_f N_\gamma + \gamma_f D_f N_q \quad (21)$$

Where c_f is the cohesion of the foundation soil, N_c , N_γ , and N_q are dimensionless bearing capacity coefficients as shown in table 4, γ_f is the unit weight of the foundation soil, B' is the effective foundation width (equal to $B_{RSF} - 2e_{B,n}$), and D_f is the depth of embedment. The friction angle in table 4 should be taken as the foundation's friction angle (ϕ_f). If groundwater is present, modifications to equation 21 may be necessary and are provided by AASHTO.⁽⁹⁾

Table 4. Bearing capacity factors.⁽⁹⁾

ϕ_f	N_c	N_q	N_γ	ϕ_f	N_c	N_q	N_γ
0	5.14	1.0	0.0	23	18.1	8.7	8.2
1	5.4	1.1	0.1	24	19.3	9.6	9.4
2	5.6	1.2	0.2	25	20.7	10.7	10.9
3	5.9	1.3	0.2	26	22.3	11.9	12.5
4	6.2	1.4	0.3	27	23.9	13.2	14.5
5	6.5	1.6	0.5	28	25.8	14.7	16.7
6	6.8	1.7	0.6	29	27.9	16.4	19.3
7	7.2	1.9	0.7	30	30.1	18.4	22.4
8	7.5	2.1	0.9	31	32.7	20.6	26.0
9	7.9	2.3	1.0	32	35.5	23.2	30.2
10	8.4	2.5	1.2	33	38.6	26.1	35.2
11	8.8	2.7	1.4	34	42.2	29.4	41.1
12	9.3	3.0	1.7	35	46.1	33.3	48.0
13	9.8	3.3	2.0	36	50.6	37.8	56.3
14	10.4	3.6	2.3	37	55.6	42.9	66.2
15	11.0	3.9	2.7	38	61.4	48.9	78.0
16	11.6	4.3	3.1	39	67.9	56.0	92.3
17	12.3	4.8	3.5	40	75.3	64.2	109.4
18	13.1	5.3	4.1	41	83.9	73.9	130.2
19	13.9	5.8	4.7	42	93.7	85.4	155.6
20	14.8	6.4	5.4	43	105.1	99.0	186.5
21	15.8	7.1	6.2	44	118.4	115.3	224.6
22	16.9	7.8	7.1	45	133.9	134.9	271.8

The factor of safety against bearing failure ($FS_{bearing}$) is computed according to equation 22. The factor of safety must be greater than or equal to 2.5. If not, increase the width of the GRS abutment and RSF (by increasing the length of the reinforcements), replace the foundation soil with a more competent soil, or add embedment depth.

$$FS_{bearing} = \frac{q_n}{\sigma_{v,base,n}} \geq 2.5 \quad (22)$$

Beyond bearing capacity, consolidation settlement should be evaluated to ensure excessive deformations will not occur over the life of the bridge. Design considerations such as excavation and the RSF reduce the pressure on the foundation soil. Nevertheless, settlement of the foundation soil should be assessed as with any other spread footing according to FHWA guidance.⁽⁷⁾ Determining the criterion for tolerable foundation settlement is left up to the engineer.

A stress history analysis should be conducted to ascertain settlement and stability prediction. Answers to the following questions will provide insight on the stress history for an efficient design:

- Is the site bridge a replacement project built in the same location?
- What was the performance of the existing bridge?
- Were there any chronic maintenance issues associated with the existing structure?
- What was the combined weight of the abutment and superstructure within the footprint of the new bridge foundation? How does that stress compare with the stress of the new structure?
- Does the site involve an excavation equivalent to the weight of the new GRS-IBS?
- Can the new bridge be built behind the existing foundation?

4.3.6.3 Global Stability

Global stability is evaluated according to classical slope stability theory using either rotational or wedge analysis. To facilitate the global stability check, it is prudent to collect accurate soil property information. Standard slope stability computer programs can then be used to assess the global and compound stability of a GRS structure. The factor of safety for global stability should equal at least 1.5.

4.3.7 Step 7—Conduct Internal Stability Analysis

The internal stability analysis will vary slightly depending on whether ASD or LRFD is the chosen design method. ASD is presented in this chapter. For guidance on LRFD, refer to appendix B.

4.3.7.1 Ultimate Capacity

The ultimate vertical capacity of a GRS abutment is found either empirically or analytically. It is recommended that the ultimate capacity be found empirically if possible. A performance test should be conducted to determine the ultimate capacity if the reinforced fill is different from those used in the performance tests reported in this guide (see appendix A). Testing will provide the most accurate results for the design. If a performance test cannot be performed, the analytical method can be used to determine the ultimate capacity.

4.3.7.1.1 Empirical Method: Empirically, the results of an applicable performance test using the same geosynthetic reinforcement and compacted granular backfill as planned for the site should be used. The *ultimate vertical capacity* in this case is defined as the stress at which the performance

test mass strains 5 percent vertically. The ultimate vertical capacity is found in figure 20. For this performance test, the nominal capacity ($q_{ult,emp}$) is equal to 26 ksf for a vertical strain of 5 percent.

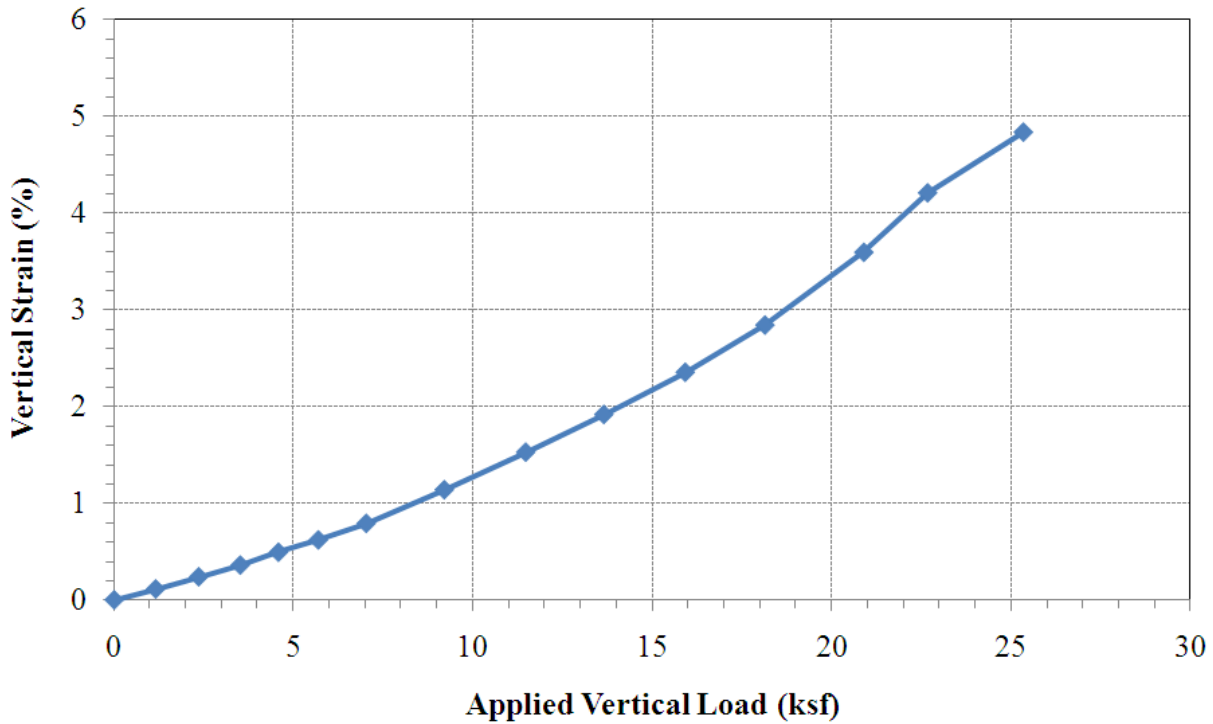

Figure 20. Graph. Design envelope for vertical capacity and strain at 8-inch reinforcement spacing.

Note that figure 20 represents the load-settlement performance of a GRS structure with reinforcement spaced at 8 inches, well-compacted AASHTO No. 89 fill material (having a friction angle of 48 degrees and no cohesion), and 4,800 lb/ft woven PP geosynthetic reinforcement. Other materials have also been tested and are shown in the synthesis report.⁽¹⁾

If the materials used are outside the recommendations provided in chapter 3, then a performance test must be performed to obtain the applicable stress-strain curve similar to figure 20. Guidance on setting up a performance experiment is given in appendix B. The total allowable pressure on the GRS abutment ($V_{allow,emp}$) is the ultimate capacity ($q_{ult,emp}$) divided by a factor of safety for capacity ($FS_{capacity}$) of 3.5, as shown in equation 23.

$$V_{allow,emp} = \frac{q_{ult,emp}}{FS_{capacity}} = \frac{q_{ult,emp}}{3.5} \quad (23)$$

The applied vertical stress ($V_{applied}$), which is equal to the unfactored sum of the vertical pressures on the bridge bearing area, must be less than $V_{allow,emp}$ (see equation 24). This includes the DL from the bridge (q_b) and the LL on the superstructure (q_{LL}). The DL due to the road base (q_{rb}) and the LL due to the approach pavement (q_i) are located behind the bearing area and are therefore not included in vertical capacity calculations related to the bridge superstructure.

$$V_{applied} = q_b + q_{LL} \leq V_{allow,emp} \quad (24)$$

4.3.7.1.2 Analytical Method: As an alternative, the load-carrying capacity of a GRS wall and abutment can also be evaluated using an analytical formula called the soil-geosynthetic composite capacity.⁽¹¹⁾ The analytical formula was originally developed for GRS walls, but it is applicable to GRS abutments as well. Note that the analytical method assumes that the backfill satisfies the criteria outlined in chapter 3.

The ultimate load-carrying capacity ($q_{ult,an}$) of a GRS wall constructed with a granular backfill can be determined by the soil-geosynthetic composite capacity equation shown in equation 25.⁽¹¹⁾

$$q_{ult,an} = \left[0.7 \left(\frac{S_v}{6d_{max}} \right) \frac{T_f}{S_v} \right] K_{pr} \quad (25)$$

Where S_v is the reinforcement spacing, d_{max} is the maximum grain size of the reinforced backfill, T_f is the ultimate strength of the reinforcement, and K_{pr} is the coefficient of passive earth pressure for the reinforced fill (calculated in equation 26).

$$K_{pr} = \frac{1 + \sin \phi_r}{1 - \sin \phi_r} = \tan^2 \left(45^\circ + \frac{\phi_r}{2} \right) \quad (26)$$

Where ϕ_r is the friction angle of the reinforced backfill. The friction angle should be determined from a large-scale direct shear device (ASTM D3080).

The total allowable pressure on the GRS abutment ($V_{allow,an}$) is the ultimate capacity found analytically ($q_{ult,an}$) divided by a factor of safety for capacity ($FS_{capacity}$) of 3.5 (see equation 27).

$$V_{allow,an} = \frac{q_{ult,an}}{FS_{capacity}} = \frac{q_{ult,an}}{3.5} \quad (27)$$

The applied vertical stress ($V_{applied}$), which is equal to the unfactored sum of the vertical pressures on the bridge bearing area, must be less than $V_{allow,an}$ (see equation 28). This includes the DL from the bridge (q_b) and the equivalent LL on the bridge (q_{LL}). The DL due to the road base (q_{rb}) and the LL due to the approach pavement (q_i) are located behind the bearing area and are therefore not included in capacity calculations related to the bridge superstructure.

$$V_{applied} = q_b + q_{LL} \leq V_{allow,an} \quad (28)$$

4.3.7.2 Deformations

The approach for determining vertical deformation involves empirically finding the strain from an applicable performance test curve. If the materials used are within the specifications given in chapter 3, then the curve shown in figure 20 can be used. Otherwise, a performance test must be conducted (see appendix B). The lateral strain is then determined analytically assuming the theory of zero volume change.⁽¹²⁾

4.3.7.2.1 Vertical: The vertical strain of the GRS abutment is found from the intersection of the applied vertical stress due to the DL (q_b) and the performance test design envelope for vertical strain (see figure 20). The vertical strain should be limited to 0.5 percent unless the engineer decides to permit additional deformation. The vertical deformation, or settlement, of the GRS abutment is the vertical strain multiplied by the height of the wall or abutment. Because the GRS abutment is built

with a granular fill, the majority of settlement within the GRS abutment will occur immediately after the placement of DL (q_b) and before the bridge is opened to traffic.

The settlement of the underlying foundation soils is determined separately using classic soil mechanics theory for immediate (elastic) and consolidation settlement. Factors such as excavation and the RSF should be taken into account, as the removal of overburden relieves stress on the foundation soil. Settlement of the foundation soil can be calculated using the FHWA *Soils and Foundations Reference Manual*.⁽⁷⁾

4.3.7.2.2 Lateral: In response to a vertical load, the composite behavior of a properly constructed GRS mass is such that both the reinforcement and soil strain laterally together. This fact can be used to predict both the maximum lateral reinforcement strain and the maximum face deformation at a given load. The method conservatively assumes a zero volume change in the GRS abutment, which represents a worst-case scenario. The maximum lateral displacement of the abutment face wall can be estimated using equation 29.⁽¹²⁾ The lateral strain (ϵ_L) is then found using equation 30 and should be limited to 1 percent.

$$D_L = \frac{2b_{q,vol} D_v}{H} \quad (29)$$

$$\epsilon_L = \frac{D_L}{b_{q,vol}} = \frac{2D_v}{H} = 2\epsilon_v \quad (30)$$

Where $b_{q,vol}$ is the width of the load along the top of the wall (including the setback), D_v is the vertical settlement in the GRS abutment, H is the wall height including the clear space distance, and ϵ_v is the vertical strain at the top of the wall. Note that equation 29 and equation 30 come from the assumptions of a triangular lateral deformation and a uniform vertical deformation (see figure 21). This assumption is based on observed deformation behavior of GRS. Also note that the location of the maximum lateral deformation depends on the loading and fill conditions, but the volume gained will still equal the volume lost. The maximum deformation of a GRS abutment often occurs in the top third of the abutment/wall.⁽¹¹⁻¹³⁾

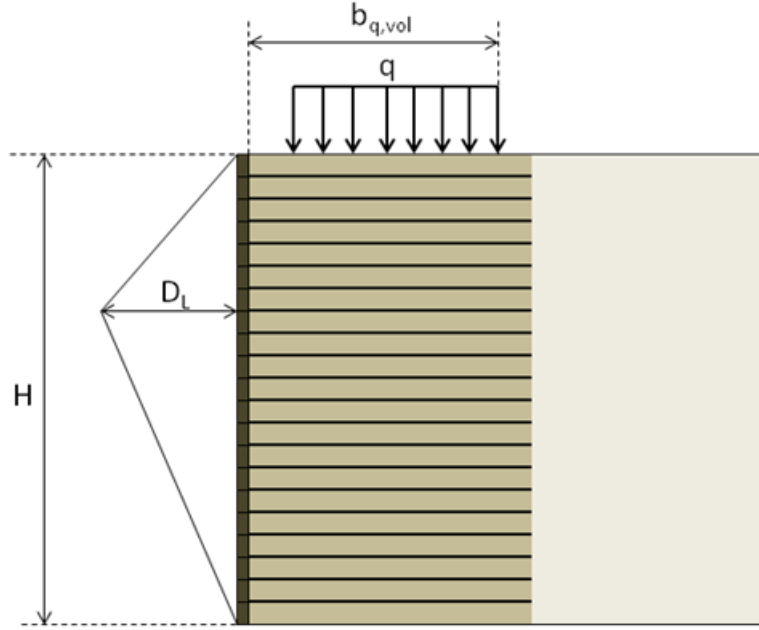

Figure 21. Illustration. Lateral deformation of a GRS structure.

4.3.7.3 Required Reinforcement Strength

The required reinforcement strength in the direction perpendicular to the wall face (T_{req}) can be determined analytically by equation 31.⁽¹¹⁾ The required reinforcement strength should be calculated at each layer of reinforcement to ensure adequate strength throughout the GRS abutment.

$$T_{req} = \left[\frac{\sigma_h}{0.7 \left(\frac{S_v}{6d_{max}} \right)} \right] S_v \quad (31)$$

Where S_v is the reinforcement spacing, d_{max} is the maximum grain size of backfill, and σ_h is the total lateral stress within the GRS abutment at a given depth and location (calculated in equation 32).

$$\sigma_h = \sigma_{h,W} + \sigma_{h,bridge,eq} + \sigma_{h,rb} + \sigma_{h,t} \quad (32)$$

Where $\sigma_{h,W}$ is the lateral earth pressure using Rankine's active stress condition (equation 2), $\sigma_{h,bridge,eq}$ is the lateral pressure due to the equivalent bridge load (calculated in equation 33), $\sigma_{h,rb}$ is the lateral pressure due to the road base (calculated in equation 34), and $\sigma_{h,t}$ is the lateral pressure due to the roadway LL (calculated in equation 35). To simplify calculations, the approach LL and road base DL are extended across the abutment. The vertical components of these loads are then subtracted from the bridge DL and LL, giving an equivalent bridge load. The lateral stress due to the equivalent bridge load is then calculated according to Boussinesq theory. The location of interest to determine the maximum lateral pressure is directly underneath the centerline of the bridge bearing width.

$$\sigma_{h,bridge,eq} = \frac{(q_b + q_{LL}) - (q_{rb} + q_t)}{\pi} [\alpha_b + \sin(\alpha_b) \cos(\alpha_b + 2\beta_b)] K_{ar} \quad (33)$$

$$\sigma_{h,rb} = q_{rb} K_{ar} \quad (34)$$

$$\sigma_{h,t} = q_t K_{ar} \quad (35)$$

Where q_b , q_{rb} , q_t , and q_{LL} are the bridge DL, road base DL, roadway LL, and bridge LL surcharges, respectively, and α_b and β_b are the angles shown in figure 15, found using equation 36 and equation 37, respectively.

$$\alpha_b = \tan^{-1} \left(\frac{b}{2z} \right) - \beta_b \quad (36)$$

$$\beta_b = \tan^{-1} \left(\frac{-b}{2z} \right) \quad (37)$$

The required reinforcement strength (T_{req}) must satisfy two criteria: (1) it must be less than the allowable reinforcement strength (T_{allow}), and (2) it must be less than the strength at 2 percent reinforcement strain ($T_{@ \epsilon=2\%}$)

In design, a minimum value of the ultimate reinforcement strength (T_{allow}) is needed to ensure adequate ductility and satisfactory long-term performance. In addition, it is prudent to specify the resistance required at the working load ($T_{@ \epsilon=2\%}$) to ensure satisfactory performance under the in-service condition.

For abutments, a minimum ultimate tensile strength (T_f) of 4,800 lb/ft is required. The allowable reinforcement strength (T_{allow}) is found by applying a factor of safety for reinforcement strength (FS_{reinf}) of 3.5 to the ultimate strength (see equation 38). The required reinforcement strength (T_{req}) must be less than T_{allow} .

$$T_{allow} = \frac{T_f}{FS_{reinf}} = \frac{T_f}{3.5} \quad (38)$$

Since geosynthetic reinforcements of similar strength can have rather different load-deformation relationships depending on the manufacturing process and the polymer used, it is important that T_{req} be less than the strength at 2 percent reinforcement strain. The strength of the reinforcement at 2 percent ($T_{@ \epsilon=2\%}$) is often given by the geosynthetic manufacturer. If T_{req} is greater than $T_{@ \epsilon=2\%}$, a different geosynthetic must be chosen, the ultimate strength must be increased, or the reinforcement spacing must be decreased.

While the strength of the reinforcement can theoretically vary along the height of the GRS abutment, it is recommended that only one strength of reinforcement be used throughout the entire abutment. This simplifies the construction process and avoids placement errors for the reinforcement.

4.3.7.3.1 Depth of Bearing Bed Reinforcement: The required reinforcement strength (T_{req}) is found at each 8-inch primary spacing layer. If T_{req} is greater than the allowable reinforcement strength (T_{allow}) or the strength at 2 percent strain ($T_{@ \epsilon=2\%}$), then the reinforcement spacing must be reduced to 4 inches to the depth at which T_{req} is less than T_{allow} or $T_{@ \epsilon=2\%}$. This depth is termed the *bearing reinforcement bed*. The minimum required depth is five courses of block.

To check that 4-inch spacing for the bearing reinforcement bed is adequate, calculate the required reinforcement strength again for this new spacing in the top layers to ensure that T_{req} is less than T_{allow} and $T_{@ε=2\%}$ for all layers throughout the GRS abutment.

4.3.8 Step 8—Implement Design Details

Figure 22 and figure 23 are typical cross sections of a GRS wall (or wing wall) and an abutment face wall and illustrate design details that will be discussed in this section.

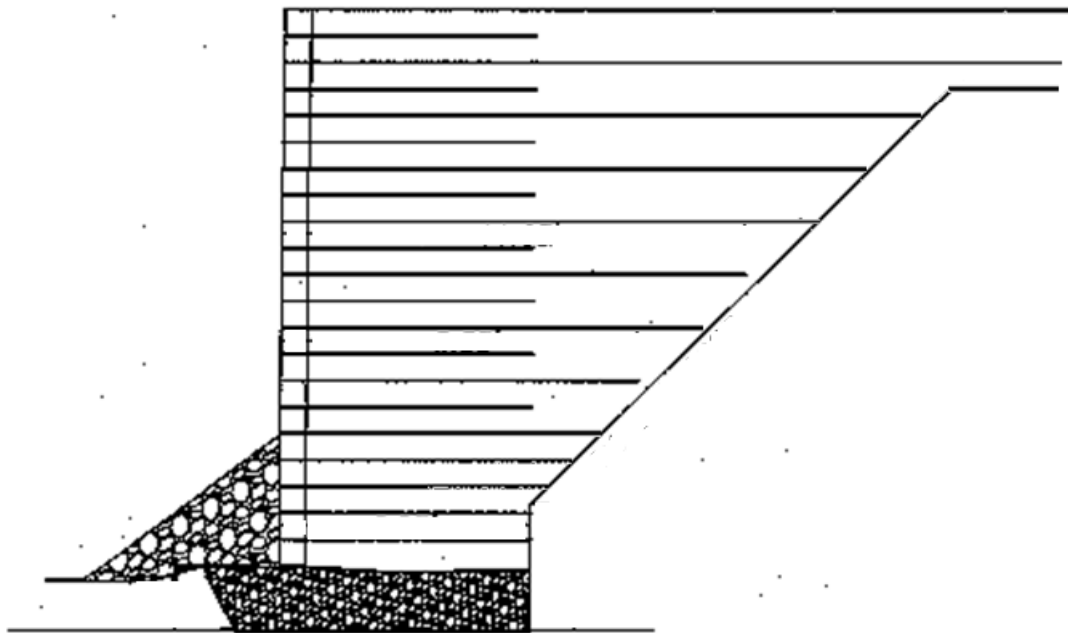

Courtesy of Defiance County, OH

Figure 22. Illustration. Typical cross section of a GRS wing wall.

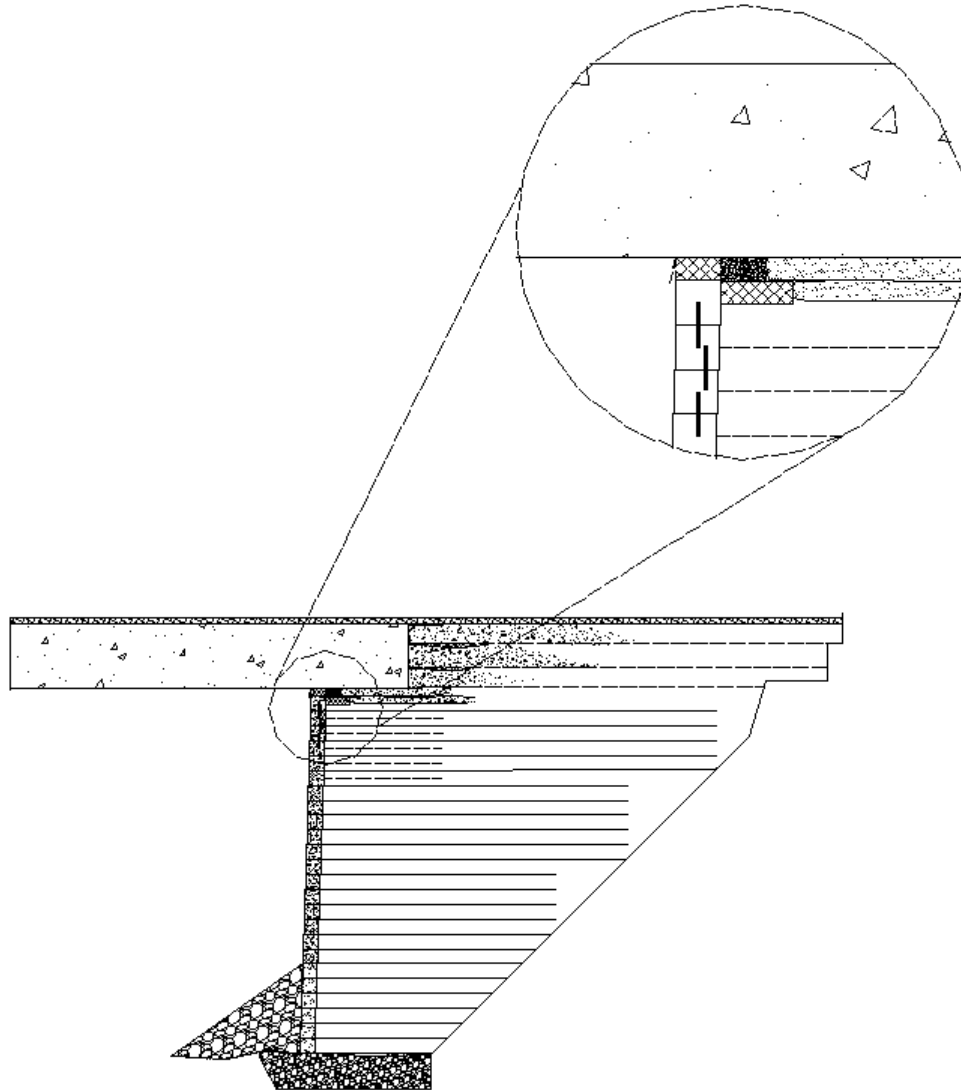

Courtesy of Defiance County, OH

Figure 23. Illustration. Typical cross section of a GRS abutment face wall.

In the case of an abutment, finalize the design layout for ease of construction, drainage, and other considerations that might affect the performance, serviceability, or efficiency of design. The following are some GRS design implications and related details for consideration:

- Conduct a hydraulic analysis in accordance with all appropriate regulatory and policy guidance (see chapter 5). Consult a licensed hydraulic engineer if necessary.
- Ensure that the face of the abutment (which includes the parapet) is wide enough to accommodate the installation of guardrails (see figure 24). The additional width should be enough to allow the guardrail to lay down. This lay-down length is approximately 4 ft. Steel rail posts should be used because wooden posts are nearly impossible to drive into the GRS mass.



Figure 24. Photo. Guardrail lay-down distance.

- Consider a core of native soil in the center of the abutment face and two adjacent wing walls to minimize excavation (see figure 25). The wing walls can be truncated like the abutment. Extend the wing walls sufficiently into the cut slope to prevent erosion caused by undermining or piping. This should be a minimum of two facing-block lengths.



Figure 25. Photo. GRS abutment and wing walls built around core of native soil

- Determine whether to build wing walls with either a full face or a stepped face that leads into the cut slope. The decision depends on several factors related to the height of the abutment, grade of fill slope (which is usually at 2:1), and time and materials. For abutments less than 12 ft in height, a full face is probably most efficient as it is the easiest to construct. However, for abutments greater than 12 ft, it might be more

efficient to design a stepped-face wall (i.e., tiered wall) that leads into the cut slope. Stepped walls use less material but require additional labor in building the second foundation to support the extended stepped wall. In either case, all facing blocks should be supported on well-compacted structural fill.

- Include channel drains along the wings walls to facilitate runoff. The drain path should not be located directly against the wall face. Armor the drain path with a strip of geotextile beneath a layer of channel rock. Grade in compacted native soil against the wing walls with a slope leading to the drainage path.
- GRS-IBS has been used for bridges with skew, superelevation, and grade without problems or serviceability issues.
 - For a skewed bridge, it is important to maintain the minimum bearing area of 2.5 ft along the length of the abutment face wall.
 - For a bridge with superelevation, it is important to ensure that the minimum number of bearing bed reinforcement layers beneath the beam seat (calculated in step 7) are installed across the length of the abutment face.
 - At this time, there are no special considerations for opposing GRS abutments that support a bridge on a grade.
- Contain the GRS integrated approach fill by wrapping the geotextile layers adjacent to the beam ends to prevent lateral spreading (see chapter 7). Extend the reinforcement layers at the approach back onto the road, as indicated in figure 23.
- Avoid any abrupt transition of soil type from the roadway to the bridge. While the RSF and abutment should use a reinforcement with a minimum ultimate strength of 4,800 lb/ft, a lighter geosynthetic of about 2,400 lb/ft could be used for the integrated approach. However, it is recommended that only one strength of reinforcement be used on site to simplify the construction process and avoid placement errors.
- Plan ahead to avoid trenching, and account for the possible installation of utilities.
- Locate and plan to accommodate existing and potential future utilities.

4.3.9 Step 9—Finalize Material Quantities and Layout

To develop the reinforcement schedule, choose a reinforcement length that makes use of the entire roll of the reinforcement material. Reinforcement material is usually 12- to 18-ft wide. For example, the width of a PP geosynthetic roll is 12 ft, and the base of a GRS wall is 6 ft including the width of the wall face. The roll can be cut in half by a chainsaw, and a 6-ft-wide roll can be used to build the base of the wall. The remaining 6-ft-wide rolls can be used for secondary or intermediate layers of reinforcement in the walls.

Draw the layout to scale to avoid errors in the calculation of quantities. Add 10 percent to the estimate of all materials. When using CMU, use the exact dimensions of $7\frac{5}{8}$ inches by $7\frac{5}{8}$ inches by $15\frac{5}{8}$ inches and buy both corner and face blocks.

Building GRS abutments vertically without a batter eliminates the need to trim blocks. This will make it more difficult to hide lateral movement and may give an illusion of instability when the structure is, in fact, stable. Use only high-quality, well-graded gravel, as specified in chapter 3.

4.4 DESIGN EXAMPLE: BOWMAN ROAD BRIDGE, DEFIANCE COUNTY, OH

Construction of Bowman Road Bridge was completed in October 2005 by a Defiance County, OH, construction crew. This project represents the initial deployment of GRS-IBS. The structure was chosen for a design example because it demonstrates many of the variables that can be accommodated by GRS-IBS technology and illustrates the versatility of the construction method.

4.4.1 Step 1—Establish Project Requirements

GRS-IBS was used for the Bowman Road Bridge project. The project included an abutment and a wing wall on each side of the bridge. A top view of the proposed project is shown in figure 26. Figure 27 is an aerial view of the site with the proposed bridge superimposed.

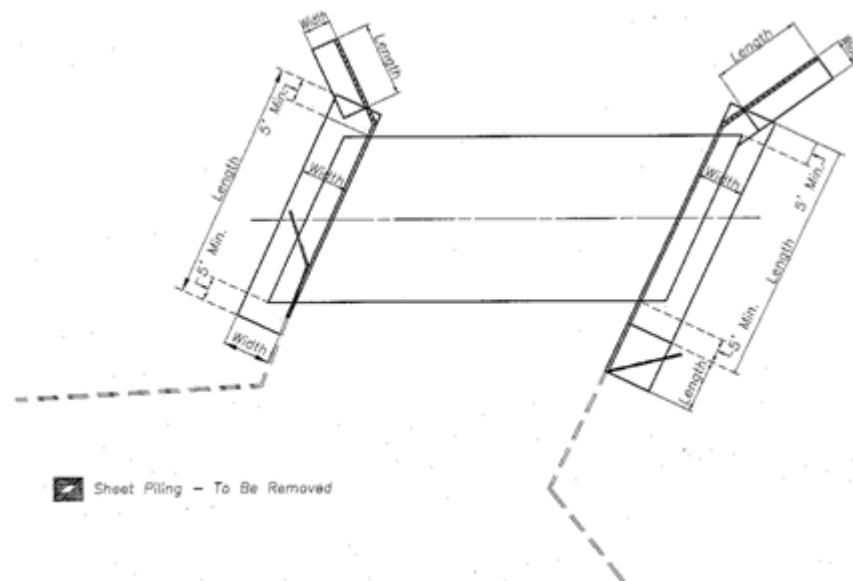

Figure 26. Illustration. Top view of Bowman Road Bridge showing the bridge, abutments, and wing walls.

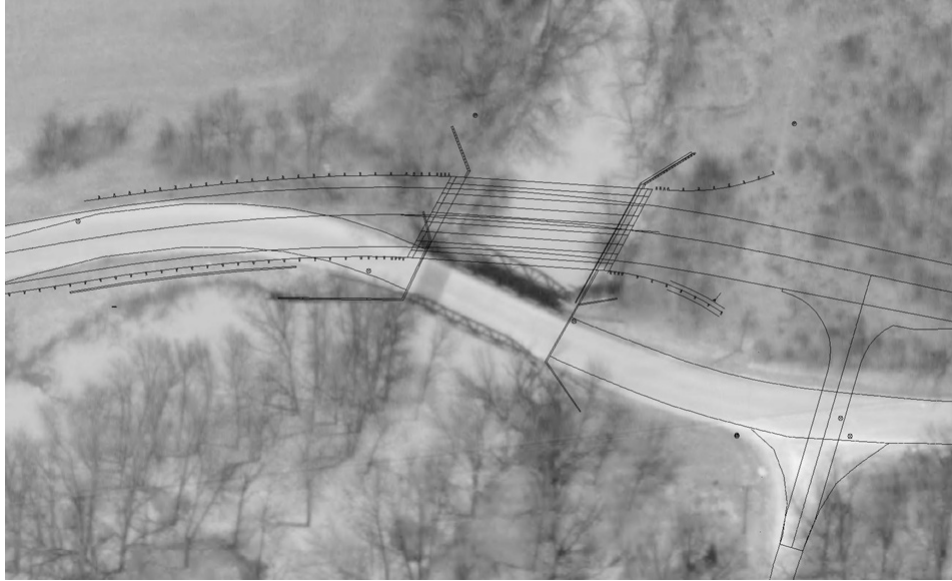

Figure 27. Illustration. Aerial view of the existing site with the planned Bowman Road Bridge superimposed.

Schematics of the proposed abutments are shown in figure 28 and figure 29. The project requirements are as follows:

- Geometry.
 - Wall height (H_{abut}): 15.25 ft.
 - Abutment length (L_{abut}): 43.6 ft.
 - Bridge width (B_b): 34 ft.
 - Batter (ω): 2 degrees.
 - Wall placement with respect to ground conditions (back slope, toe slope): None.
 - Skew (S_k): 24 degrees.
 - Grade (G): 0.006 ft/ft.
 - Superelevation (S_e): 7.6 degrees.
- Loading Conditions.
 - Soil surcharge: Road base will be placed behind the bridge beam to create a smooth transition.
 - DL: DL includes the weight of the bridge beam along with any corresponding components.
 - LL: LL includes traffic and truck loads which are simulated as a surcharge.
 - Seismic load: Seismic effects are negligible in this area.
 - Impact loads: No impact loads are considered.
 - Loads from adjacent structures: Not applicable.

- Performance Criteria.
 - Design code: ASD.
 - Tolerable movements.
 - Vertical settlement: Vertical strain (ϵ_V) is limited to 0.5 percent.
 - Lateral displacements: Lateral strain (ϵ_L) is limited to 1 percent.
 - Design life: 100 years.
 - Constraints.
 - Environmental: None.
 - Construction: Sheet piling from the existing bridge remains in place, reducing the need for two wing walls in the IBS. Only one wing wall is required.

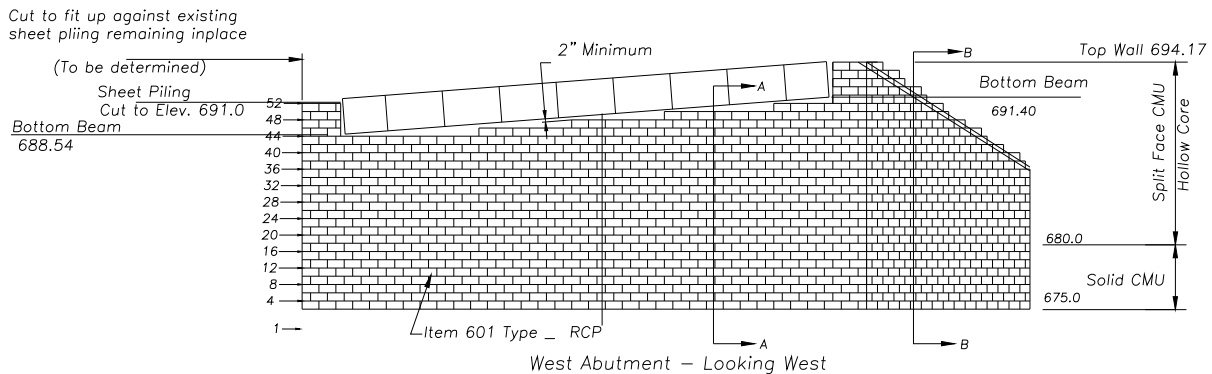

Figure 28. Illustration. Schematic of the west abutment for Bowman Road Bridge.

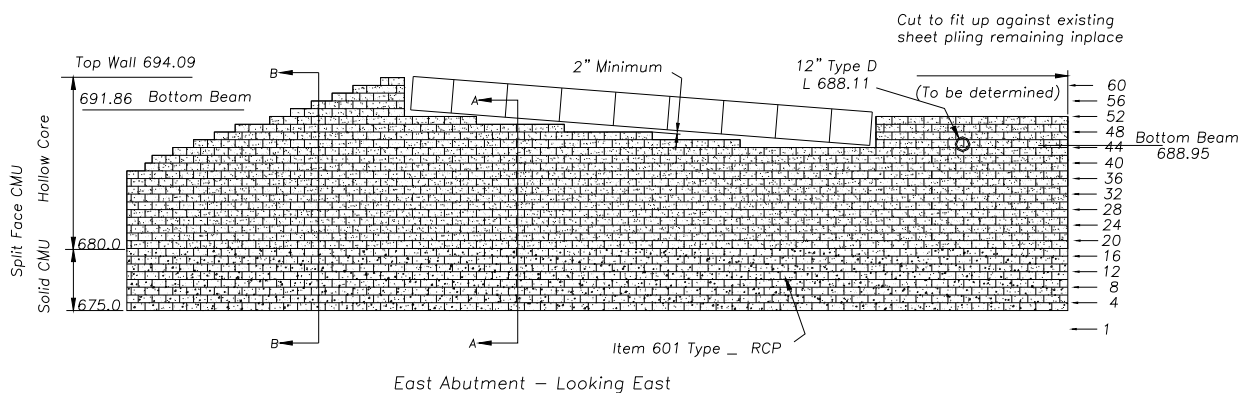

Figure 29. Illustration. Schematic of the east abutment for Bowman Road Bridge.

4.4.2 Step 2—Site Evaluation

The previous bridge at the site was replaced because it was functionally obsolete and structurally deficient. The previous bridge did not experience any problems related to settlement or excessive deformations due to the site conditions. However, a sheet pile wall was installed to protect the stone wall abutments from erosion. The site evaluation determined that the existing sheet piling

should remain in place to support the stream bank. This eliminated the need for wing walls on one side adjacent to the old bridge.

The replacement structure required realignment to meet current road design standards for roadway safety because the location had been prone to accidents. The new Bowman Road Bridge crosses Powell Creek. The proposed location of the new abutments adjacent to the old bridge was not expected to cause any problems with the stream flow.

A hydraulic analysis confirmed that the existing bridge did not have any appreciable potential scour. Therefore, an RSF with appropriate scour countermeasures (in this case, riprap) was used.

A subsurface evaluation was conducted by performing standard penetration tests (SPTs) near the site. The physical characteristics of the soil were determined through index tests taken on split spoon samples. The foundation soil at the site was an overconsolidated clay (with intermediate layers of sandy silt and gravels) with N-values greater than 50 blows per ft at the elevation of the bottom of the abutment (determined from figure 28 and figure 29). Local experts indicated the clay had historically been preloaded with a nearly 1-mi-thick sheet of ice. The clay in this region is also known to be fat and sticky when wet. The bearing capacity of the stiff clay had not been a problem in past projects in the area.

The N-value of the foundation soil can be correlated into an undrained shear strength using published guidance.⁽⁸⁾ For blow counts greater than 30 blows per ft, the unconfined compressive strength is greater than 8,000 lb/ft². The undrained shear strength is therefore estimated as at least 4,000 lb/ft². The design properties for the foundation soil are shown in table 5. The retained backfill is composed of the same material as the foundation soil.

Table 5. Foundation and retained backfill soil properties.

Property	Notation	Measurement
Foundation and backfill soil unit weight	γ_f, γ_b	120 lb/ft ³
Foundation and backfill soil undrained shear strength	c_u, c_b	4,000 lb/ft ²
Foundation and backfill soil effective cohesion	c'_f, c'_b	400 lb/ft ²
Foundation and backfill soil effective friction angle	ϕ'_f, ϕ'_b	28 degrees

The road base was a granular fill material that was brought to the site. For the Bowman Road Bridge project, the properties of the road base are given in table 6.

Table 6. Road base soil properties.

Property	Notation	Measurement
Road base unit weight	γ_{rb}	140 lb/ft ³
Road base cohesion	c_{rb}	0 lb/ft ²
Road base friction angle	ϕ_{rb}	40 degrees

The reinforced fill for the GRS abutment was a select granular fill (AASHTO No. 89 stone). Testing was performed on this fill to determine the c and ϕ properties. The properties of this fill are provided in table 7.

Table 7. Reinforced fill properties.

Property	Notation	Measurement
Reinforced fill unit weight	γ_r	110 lb/ft ³
Maximum diameter of reinforced fill	d_{max}	0.5 inches
Reinforced fill cohesion	c_r	0 lb/ft ²
Reinforced fill friction angle	ϕ_r	48 degrees

4.4.3 Step 3—Evaluate Project Feasibility

As mentioned in step 2, scour was not a significant concern for this bridge. The project was therefore considered feasible for this site. Scour protection was added as a precaution. The riprap was sized for 8.8–10.2 ft/s to create a scour protection apron adjacent to and in front of the abutment face and wing walls. Prior to placement, a 5- to 8-ft-wide strip of geotextile reinforcement between the face of the RSF and the riprap was pinned under the first course of facing blocks to secure it in place. The purpose of the geotextile reinforcement was to create a barrier to mitigate loss of soil beneath the riprap.

4.4.4 Step 4—Determine Layout of GRS-IBS

1. Define the geometry of the abutment face wall and wing walls: See step 1.
2. Layout the abutment with respect to the superstructure: See figure 29. The distance between the abutment faces was 72 ft. Therefore, since the length of the bridge was greater than 25 ft, the minimum bearing width (b) for the superstructure was 2.5 ft. A bearing width of 4 ft, however, had been chosen for this bridge.
3. Account for setback and clear space: The bridge seat had a setback of 8 inches from the edge of the wall. The clear space was 4 inches, which was greater than 2 percent of the wall height.
4. Determine the depth and volume of excavation necessary for construction:
 - A base width of the wall including the block face of 6 ft was chosen for this abutment since the span length was greater than 25 ft and $0.3H$ was less than the 6-ft minimum. Subtracting the wall face width (7.625 inches), the reinforcement length at the base of the wall was 5.4 ft. This equates to a B/H ratio of 0.35, which is greater than the minimum B/H ratio of 0.3.
 - Excavation of 1.5 ft (one-quarter the width, including the block face) was made at the base in front of the face of the wall to accommodate for construction of the RSF. The total width of the RSF was therefore 7.5 ft.

- The depth of the excavation for the RSF was equal to one-quarter the width of the base including the block face—1.5 ft (see figure 12).
5. Select the length of reinforcement for the abutment: The reinforcement length at the base of the wall was equal to 6 ft (or 5.4 ft not including the reinforcement necessary for the frictional connection). The reinforcement lengths up the wall were chosen based on the cut slope angle and an optimization of the width of the reinforcement rolls. The reinforcement schedule is shown in figure 30.

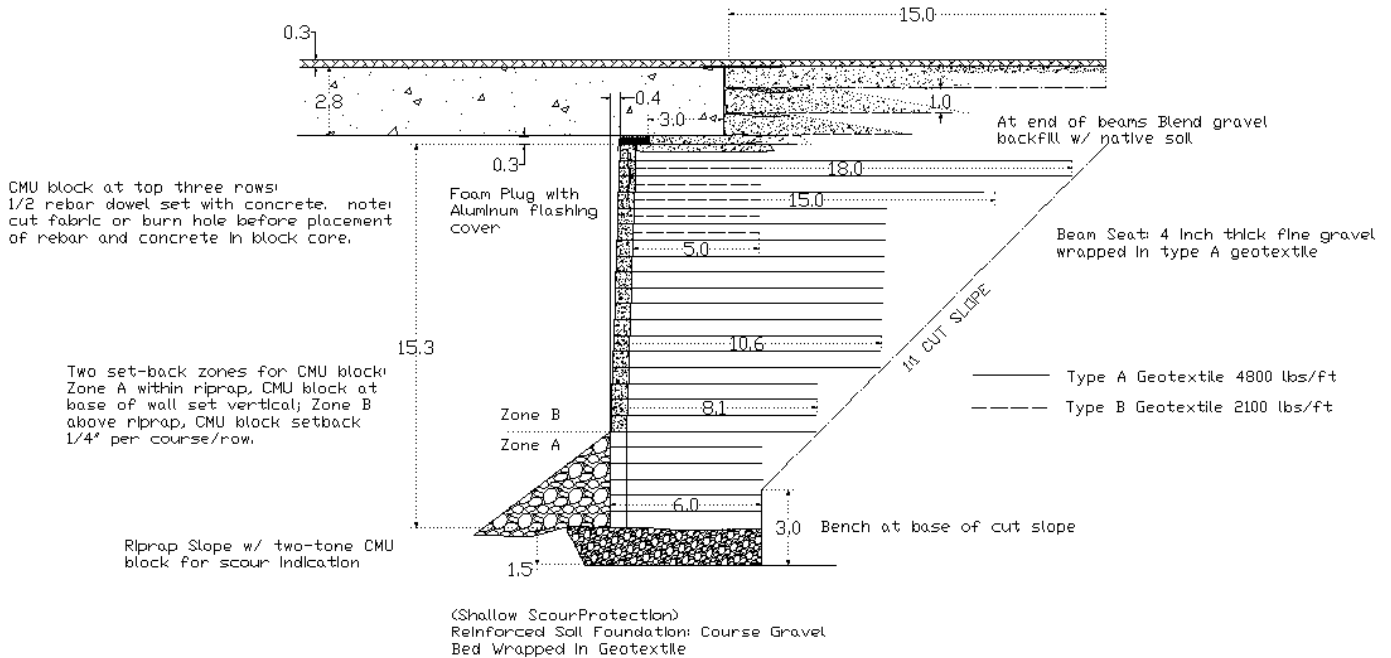

Figure 30. Illustration. Reinforcement schedule and RSF dimensions for Bowman Road Bridge.

6. Add a bearing reinforcement zone underneath the bridge seat: The primary reinforcement spacing was 8 inches at the wall face. The spacing of the bearing reinforcement bed was 4 inches, half of the primary spacing. The length of the bearing reinforcement bed was 5 ft. The depth of the bearing reinforcement bed would be determined when the internal stability analysis was conducted (step 7). At a minimum, however, there would be five intermediate layers between the primary reinforcement layers (at 8-inch spacing) in the bearing reinforcement zone (see figure 12).
7. Blend the reinforcement layers in the integration zone to create a smooth transition: Additional work was needed to integrate the substructure with the superstructure within the integration zone at the approach (see figure 12). There were three layers of wrapped geotextile reinforcement spaced at 0.9 ft. This is described in chapter 7.

4.4.5 Step 5—Calculate Loads

The applicable surcharges and loads associated with the structure were a combination of vertical and lateral components. The vertical components include the surcharges due to the DL (superstructure

and road base from the integrated approach) and the LL (superstructure and roadway), along with the weight of the GRS abutment. The lateral earth pressure due to the retained backfill, shown in table 8, were also considered. Lateral loads resulting from the DL and LL were calculated separately during the external and internal stability calculations performed in step 6 and step 7.

Table 8. Loads and surcharges for Bowman Road Bridge.

Property	Notation	Measurement	Equation
Bridge DL	q_b	2,600 lb/ft ²	Given
Bridge LL	q_{LL}	1,400 lb/ft ²	Given
Roadway LL	q_t	298 lb/ft ²	$q_t = h_{eq}\gamma_b$ $h_{eq} = 2.48$ ft
Road base DL	q_{rb}	385 lb/ft ²	$q_{rb} = h_{rb}\gamma_{rb}$ $h_{rb} = 2.75$ ft
Weight of GRS abutment	W	9,257 lb/ft	$W = BH\gamma_r$
Weight of RSF	W_{RSF}	1,575 lb/ft	$W_{RSF} = B_{RSF}D_{RSF}\gamma_{rb}$
Weight of facing blocks	W_{face}	768 lb/ft	$W_{face} = N_{block} \frac{W_{block}}{L_{block}}$
Lateral load (retained backfill)	F_b	5,258 lb/ft	$F_b = \frac{1}{2}\gamma_b H^2 K_{ab}$ $K_{ab} = \frac{1 - \sin\phi_b}{1 + \sin\phi_b} = 0.361$

Note that the weight of the GRS abutment was calculated with B equal to the shortest reinforcement layer not including the width of the wall face. This is a conservative assumption to simplify hand calculations. Several software programs are available that can account for the varying shape due to different reinforcement lengths along the height of the abutment. The weight of the facing blocks (W_{face}) is the weight of an individual CMU block (42 lb) divided by the length of the block (15.625 inches), multiplied by the total number of blocks in a single column (24 in this case).

4.4.6 Step 6—Conduct an External Stability Analysis

4.4.6.1 Direct Sliding

The driving forces on the GRS abutment include the lateral forces due to the retained backfill, the road base, and the traffic surcharge.

The force due to the backfill is calculated in equation 39.

$$F_b = \frac{1}{2}\gamma_b K_{ab} H^2 = \frac{1}{2}(120)(0.361)(15.58)^2 = 5258 \text{ lb/ft} \quad (39)$$

The lateral force due to the road base and traffic surcharges are calculated in equation 40 and equation 41, respectively.

$$F_{rb} = q_{rb}K_{ab}H = 385(0.361)(15.58) = 2165 \text{ lb/ft} \quad (40)$$

$$F_t = q_tK_{ab}H = 298(0.361)(15.58) = 1676 \text{ lb/ft} \quad (41)$$

The total driving force (F_n) is then calculated in equation 42.

$$F_n = F_b + F_{rb} + F_t = 5258 + 2165 + 1676 = 9099 \text{ lb/ft} \quad (42)$$

The resisting force (R_n) is calculated according to equation 14. The total resisting weight (W_t) includes the weight of GRS plus the weight of the bridge beam plus the weight of the road base over the GRS abutment. Since the live loads are not permanent, they cannot be counted as a resisting force. Total resisting weight (W_t) is calculated in equation 43.

$$W_t = W + q_b b + q_{rb} b_{rb} = 9257 + 2600(4) + 385(0.7) = 19927 \text{ lb/ft} \quad (43)$$

The friction force (μ) is equal to $\tan \phi_{crit}$. The interface friction angle between the reinforced fill and the geotextile was measured at 39 degrees by conducting an interface direct shear test. The resisting force (R_n) calculation is shown in equation 44.

$$R_n = W_t \mu = 19927 \tan(39) = 16137 \text{ lb/ft} \quad (44)$$

The factor of safety against direct sliding (FS_{slide}) is calculated in equation 45 to make sure it is greater than 1.5.

$$FS_{slide} = \frac{R_n}{F_n} = \frac{16137}{9099} = 1.8 \geq 1.5 \quad (45)$$

4.4.6.2 Bearing Capacity

Before calculating the applied vertical bearing pressure, the eccentricity of the resulting force at the base of the wall must first be calculated using equation 20.

The moments are calculated around the center of the base of the RSF. The driving moments (calculated as a counterclockwise moment) include the lateral force due to the retained backfill, the road base DL, and the roadway LL. The calculation is shown in equation 46.

$$\begin{aligned} \sum M_D &= F_b \left(\frac{H}{3}\right) + F_{rb} \left(\frac{H}{2}\right) + F_t \left(\frac{H}{2}\right) \\ &= 5258 \left(\frac{15.58}{3}\right) + 2165 \left(\frac{15.58}{2}\right) + 1676 \left(\frac{15.58}{2}\right) \\ &= 57228 \text{ ft lb/ft} \end{aligned} \quad (46)$$

The resisting moments (calculated as a clockwise moment) include the vertical force due to the bridge and road base DLs and the bridge and roadway LLs. The weight of the GRS abutment is also included as a resisting moment. This calculation is shown in equation 47.

$$\begin{aligned}
\sum M_R &= (q_b b + q_{LL} b) \left[\left(\frac{b}{2} + a \right) - \left(\frac{B_{RSF}}{2} - x_{RSF} - b_{block} \right) \right] \\
&\quad + (q_t b_{rb,t} + q_{rb} b_{rb,t}) \left(\frac{B_{RSF}}{2} - \frac{b_{rb}}{2} \right) + W \left(\frac{B_{RSF}}{2} - \frac{B}{2} \right) \\
&= (2600 * 4 + 1400 * 4) \left[\left(\frac{4}{2} + 0.67 \right) - \left(\frac{7.5}{2} - 1.5 - 0.64 \right) \right] \\
&\quad + (298 * 0.7 + 385 * 0.7) \left(\frac{7.5}{2} - \frac{0.7}{2} \right) + 9059 \left(\frac{7.5}{2} - \frac{5.4}{2} \right) = 28098 \text{ ft lb/ft}
\end{aligned} \tag{47}$$

The total vertical load is equal to the sum of the weight of the GRS abutment, the weight of the RSF, and the load due to the DLs (bridge and road base) and LLs (bridge and roadway). This calculation is shown in equation 48.

$$\begin{aligned}
\sum V &= W + W_{RSF} + W_{face} + q_t b_t + q_{rb} b_{rb} + q_b b + q_{LL} b \\
&= 9257 + 1575 + 768 + 298(0.7) + 385(0.7) + 2600(4) + 1400(4) \\
&= 28078 \text{ lb/ft}
\end{aligned} \tag{48}$$

Thus, the eccentricity of the resulting force at the base of the RSF is calculated in equation 49.

$$e_{B,n} = \frac{\sum M_D - \sum M_R}{\sum V} = \frac{57228 - 28098}{28078} = 1.04 \tag{49}$$

The applied vertical pressure is then calculated in equation 50.

$$\sigma_{v,base,n} = \frac{\sum V}{B_{RSF} - 2e_{B,n}} = \frac{28078}{7.5 - 2(1.04)} = 5180 \frac{\text{lb}}{\text{ft}^2} \tag{50}$$

The bearing capacity is calculated in equation 51. The bearing capacity factors N_c , N_γ , and N_q were found using table 4 for the foundation friction angle of 0 degrees.

$$\begin{aligned}
q_n &= c_f N_c + \frac{1}{2} B' \gamma_f N_\gamma + \gamma_f D_f N_q \\
&= 4000(5.14) + \frac{1}{2} (7.5 - 2 * 0.94)(120)(0) + 120(1.5)(1.0) = 20740 \text{ psf}
\end{aligned} \tag{51}$$

The factor of safety against bearing capacity failure is calculated in equation 52 to make sure it is greater than 2.5.

$$FS_{bearing} = \frac{q_n}{\sigma_{v,base,n}} = \frac{20740}{5180} = 4.0 \geq 2.5 \tag{52}$$

4.4.6.3 Global Stability

Global and compound stability was checked using the software program ReSSA. Figure 31 is a screenshot of the global stability failure mode. The factor of safety was found to equal 6.6, much greater than the minimum requirement of 1.5. Global and compound stability were satisfied.

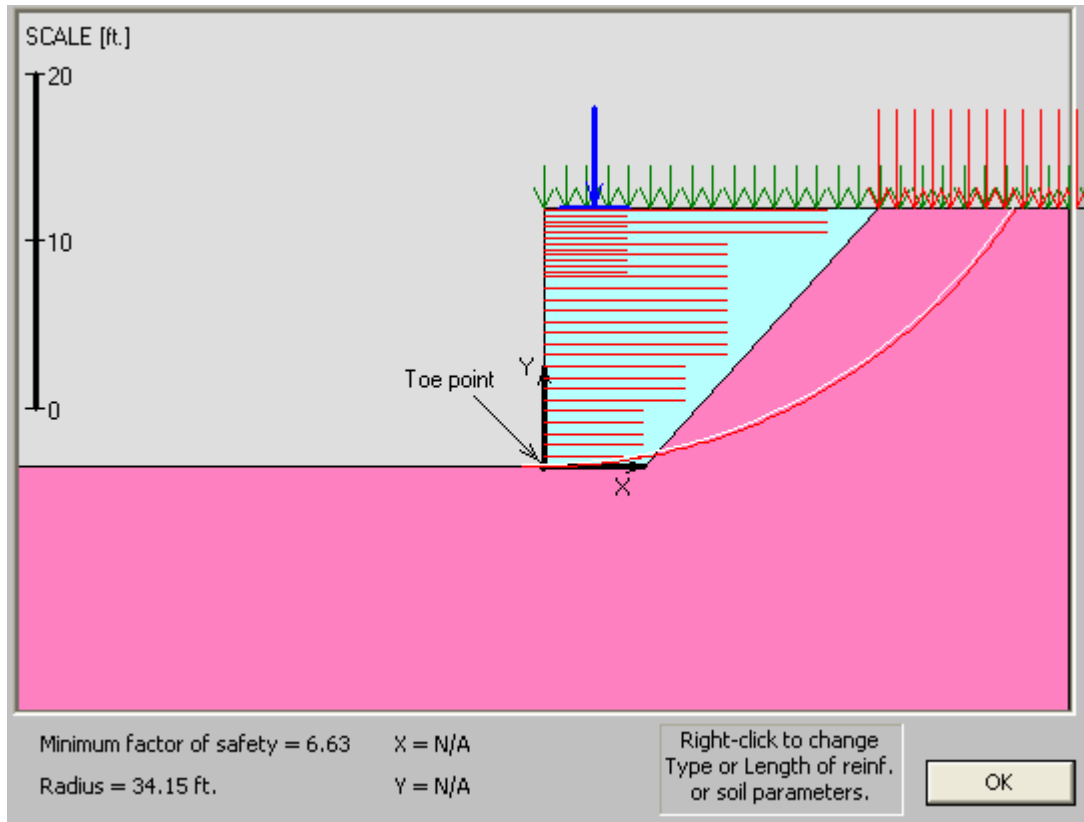

Figure 31. Screenshot. ReSSA results for global stability for Bowman Road Bridge.

4.4.7 Step 7—Conduct Internal Stability Analysis

4.4.7.1 Ultimate Capacity

The ultimate capacity of a GRS abutment can be determined using two different methods: empirical or analytical.

4.4.6.1.1 Empirical Method: The empirical method uses the load test results of a performance test on a GRS composite material identical (or very similar) to that used in the field. The ultimate capacity is found empirically as the stress at 5 percent vertical strain from the stress-strain curve shown in figure 32. For this curve, the ultimate capacity ($q_{ult,emp}$) is 26 ksf.

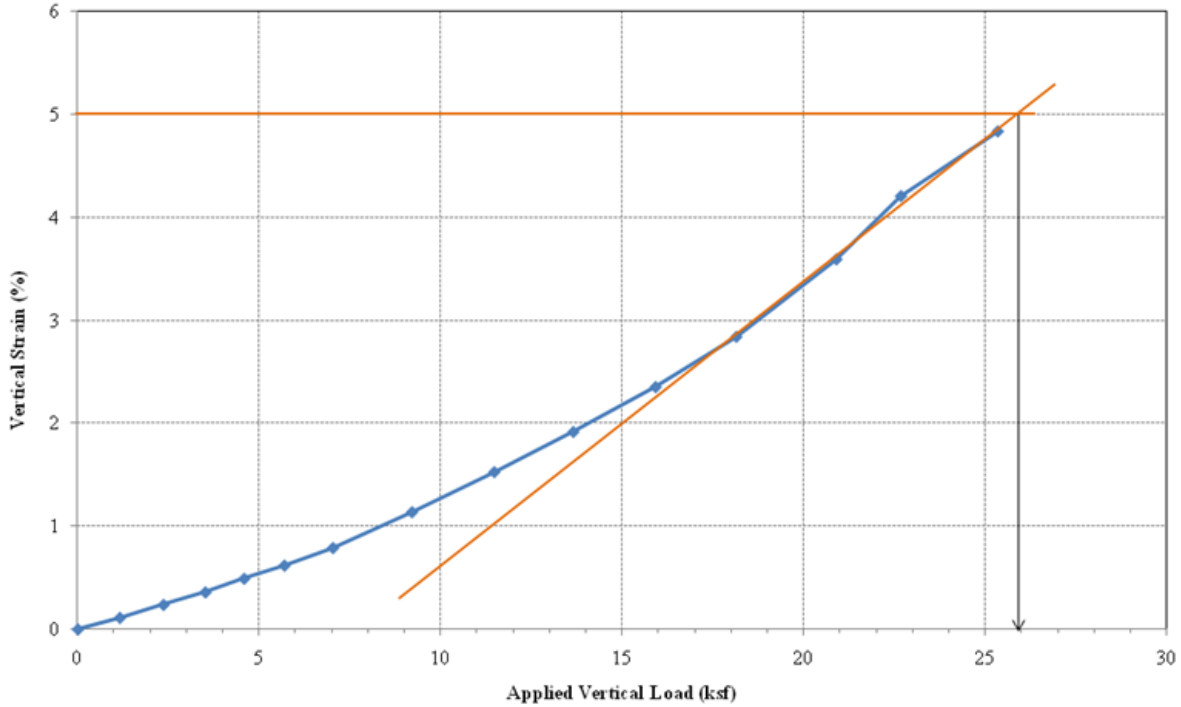

Figure 32. Graph. Stress-strain curve for Bowman Road Bridge showing ultimate capacity.

The total allowable pressure on the GRS abutment ($V_{allow,emp}$) is the ultimate capacity (q_{ult}) divided by a factor of safety for capacity ($FS_{capacity}$) of 3.5, as shown in equation 53.

$$V_{allow,emp} = \frac{q_{ult,emp}}{FS_{capacity}} = \frac{26000}{3.5} = 7429 \frac{lb}{ft^2} \quad (53)$$

The applied vertical stress ($V_{applied}$), which is equal to the unfactored sum of the vertical pressures on the bridge bearing area, must be less than $V_{allow,emp}$. This includes the DL from the bridge (q_b) and the LL due to the notional HL-93 load model (q_{LL}), as shown in equation 54.

$$V_{applied} = q_b + q_{LL} = 2600 + 1400 = 4000 \frac{lb}{ft^2} \leq V_{allow,emp} \quad (54)$$

4.4.7.1.2 Analytical Method: Alternatively, the ultimate capacity can be found analytically for a granular backfill. S_v is equal to 8 inches, d_{max} is equal to 0.5 inches, T_f is equal to 4800 lb/ft, and ϕ_r is equal to 48 degrees (see table 7). Although the spacing under the bridge bearing area was 4 inches, 8 inches was chosen in equation 55 to be conservative.

$$q_{ult,an} = \left[0.7 \left(\frac{S_v}{6d_{max}} \right) \frac{T_f}{S_v} \right] K_{pr} = \left[0.7 \left(\frac{8}{6(0.5)} \right) \frac{4800}{0.67} \right] 6.786 = 18781 \text{ lb/ft}^2 \quad (55)$$

The passive earth pressure for the reinforced fill was determined with equation 56.

$$K_{pr} = \frac{1 + \sin\phi_r}{1 - \sin\phi_r} = \frac{1 + \sin 48}{1 - \sin 48} = 6.786 \quad (56)$$

The total allowable pressure on the GRS abutment ($V_{allow,an}$) is the ultimate capacity ($q_{ult,an}$) divided by a factor of safety for capacity ($FS_{capacity}$) of 3.5, as shown in equation 57.

$$V_{allow,an} = \frac{q_{ult}}{FS_{capacity}} = \frac{18781}{3.5} = 5366 \frac{lb}{ft^2} \quad (57)$$

The applied vertical stress ($V_{applied}$), which is equal to the unfactored sum of the vertical pressures on the bridge bearing area, must be less than V_{allow} . This includes the DL from the bridge (q_b) and the LL due to trucks (q_{LL}). Applied vertical stress is calculated in equation 58.

$$V_{applied} = q_b + q_{LL} = 2600 + 1400 = 4000 \frac{lb}{ft^2} \leq V_{allow,an} \quad (58)$$

4.4.7.2 Deformations

4.4.7.2.1 Vertical: The vertical strain is estimated by using figure 32, as illustrated in figure 33 for the bridge DL (q_b) of 2,600 psf. The vertical strain is therefore about 0.3 percent—under the tolerable limit of 0.5 percent. The road base surcharge is not included since it does not act over the same location.

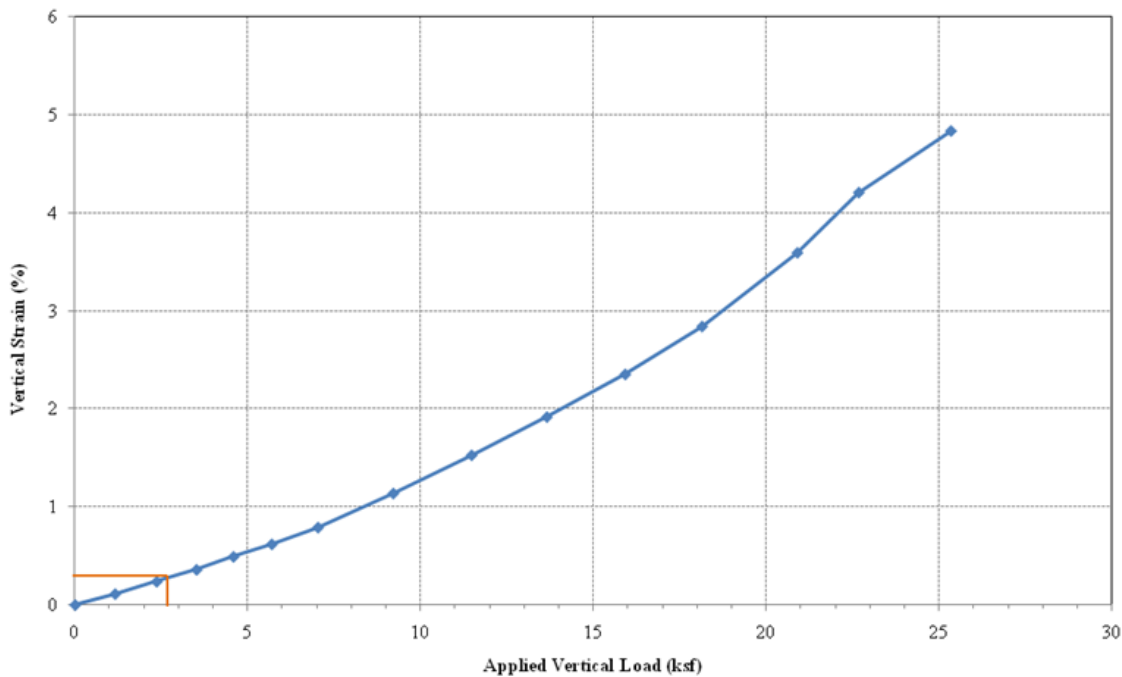

Figure 33. Graph. Vertical strain for Bowman Road Bridge.

The vertical deformation is the product of the vertical strain and the height of the GRS abutment (including the clear space distance), as shown in equation 59.

$$D_v = \varepsilon_v H = 0.003(15.58) = 0.047 \text{ ft} \quad (59)$$

4.4.7.2.2 Lateral: The lateral strain and deformation are found in equation 60 and equation 61.

$$\varepsilon_L = 2\varepsilon_v = 2(0.3\%) = 0.6\% \quad (60)$$

$$D_L = \frac{2D_v}{H}(b + a_b) = \frac{2(0.047)}{15.85}(4 + 0.67) = 0.028 \text{ ft} \quad (61)$$

4.4.7.3 Required Reinforcement Strength

The strength of the reinforcement used at Bowman Road Bridge was 4,800 lb/ft. Applying a factor of safety of 3.5, the allowable reinforcement strength is 1,371 lb/ft. According to the manufacturer, $T_{@e=2\%}$ is equal to 1,370 lb/ft.

The maximum required reinforcement strength is found as a function of depth, as shown in equation 62.

$$T_{req} = \left[\frac{\sigma_h - \sigma_c}{0.7 \left(\frac{S_v}{6d_{max}} \right)} \right] S_v \quad (62)$$

The lateral stress (σ_h) is a combination of the lateral stresses due to the road base DL ($\sigma_{h,rb}$), the roadway LL ($\sigma_{h,t}$), the GRS reinforced soil ($\sigma_{h,w}$), and an equivalent bridge load ($\sigma_{h,bridge,eq}$). To simplify calculations, the roadway LL and road base DL can be extended across the abutment. The vertical components of these loads are then subtracted from the bridge DL and LL, giving an equivalent bridge load. The lateral stresses due to the equivalent bridge load are then calculated according to Boussinesq theory. The lateral stress is calculated for each depth of interest (each layer of reinforcement). All lateral stresses are calculated and shown in table 9.

Table 9. Depth of bearing bed reinforcement calculations.

Distance from top of wall	Equivalent Bridge Load			Road Base DL and Roadway LL		GRS Fill	Total	Required Strength	Ultimate Check	2 Percent Check
	α	β	$\sigma_{h,bridge,eq}$ (psf)	$\sigma_{h,rb}$ (psf)	$\sigma_{h,t}$ (psf)	$\sigma_{h,W}$ (psf)				
0.7	2.50	-1.25	482	57	44	11	593	1024	NO	NO
1.3	1.97	-0.98	449	57	44	22	572	987	NO	NO
2.0	1.57	-0.79	400	57	44	32	533	920	NO	NO
2.7	1.29	-0.64	350	57	44	43	493	852	NO	NO
3.3	1.08	-0.54	305	57	44	54	460	794	NO	NO
4.0	0.93	-0.46	269	57	44	65	434	749	NO	NO
4.7	0.81	-0.40	239	57	44	76	415	716	NO	NO
5.3	0.72	-0.36	214	57	44	86	401	692	NO	NO
6.0	0.64	-0.32	193	57	44	97	391	675	NO	NO
6.7	0.58	-0.29	176	57	44	108	385	664	NO	NO
7.3	0.53	-0.27	162	57	44	119	381	658	NO	NO
8.0	0.49	-0.24	149	57	44	130	380	655	NO	NO
8.7	0.45	-0.23	139	57	44	140	380	655	NO	NO
9.3	0.42	-0.21	129	57	44	151	381	658	NO	NO
10.0	0.39	-0.20	121	57	44	162	384	663	NO	NO
10.7	0.37	-0.19	114	57	44	173	388	669	NO	NO
11.3	0.35	-0.17	108	57	44	184	392	676	NO	NO
12.0	0.33	-0.17	102	57	44	195	397	685	NO	NO
12.7	0.31	-0.16	97	57	44	205	403	695	NO	NO
13.3	0.30	-0.15	92	57	44	216	409	705	NO	NO
14.0	0.28	-0.14	88	57	44	227	415	717	NO	NO
14.7	0.27	-0.14	84	57	44	238	422	729	NO	NO

An example calculation for the required reinforcement strength at a depth (z) of 5.3 ft, or the eighth reinforcement layer from the top (see figure 34), is presented here. First, the lateral pressure is found in equation 63. Remember, the location of interest is directly under the centerline of the bridge load (where $x = 0.5b = 0.5(4ft) = 2$ ft).

$$\sigma_h = \sigma_{h,W} + \sigma_{h,bridge,eq} + \sigma_{h,rb} + \sigma_{h,t} = 86 + 214 + 57 + 44 = 401 \frac{\text{lb}}{\text{ft}^2} \quad (63)$$

The calculation of each aspect of the lateral pressure is shown in equation 64 through equation 67.

$$\sigma_{h,W} = \gamma_r z K_{ar} = 110(5.3) \left(\frac{1 - \sin(48\text{deg})}{1 + \sin(48\text{deg})} \right) = 110(5.3)(0.147) = 86 \frac{\text{lb}}{\text{ft}^2} \quad (64)$$

$$\begin{aligned} \sigma_{h,bridge,eq} &= \frac{(q_b + q_{LL}) - (q_{rb} + q_t)}{\pi} [\alpha_b + \sin(\alpha_b) \cos(\alpha_b + 2\beta_b)] K_{ar} \\ &= \frac{(2600 + 1400) - (385 + 298)}{\pi} [0.72\text{rad} \\ &\quad + \sin(0.72\text{rad}) \cos(0.72\text{rad} + 2 * -0.36\text{rad})] 0.147 = 214 \frac{\text{lb}}{\text{ft}^2} \end{aligned} \quad (65)$$

$$\sigma_{h,rb} = q_{rb} K_{ar} = 385(0.147) = 57 \frac{\text{lb}}{\text{ft}^2} \quad (66)$$

$$\sigma_{h,t} = q_t K_{ar} = 298(0.147) = 44 \frac{\text{lb}}{\text{ft}^2} \quad (67)$$

The values for α and β are found in equation 68 and equation 69.

$$\alpha_b = \tan^{-1} \left(\frac{b}{2z} \right) - \beta_b = \tan^{-1} \left(\frac{4}{2(5.3)} \right) - (-20.7 \text{deg}) = 41.3 \text{deg} = 0.72 \text{rad} \quad (68)$$

$$\beta_b = \tan^{-1} \left(\frac{-b}{2z} \right) = \tan^{-1} \left(\frac{-4}{2(5.3)} \right) = -20.7 \text{deg} = -0.36 \text{rad} \quad (69)$$

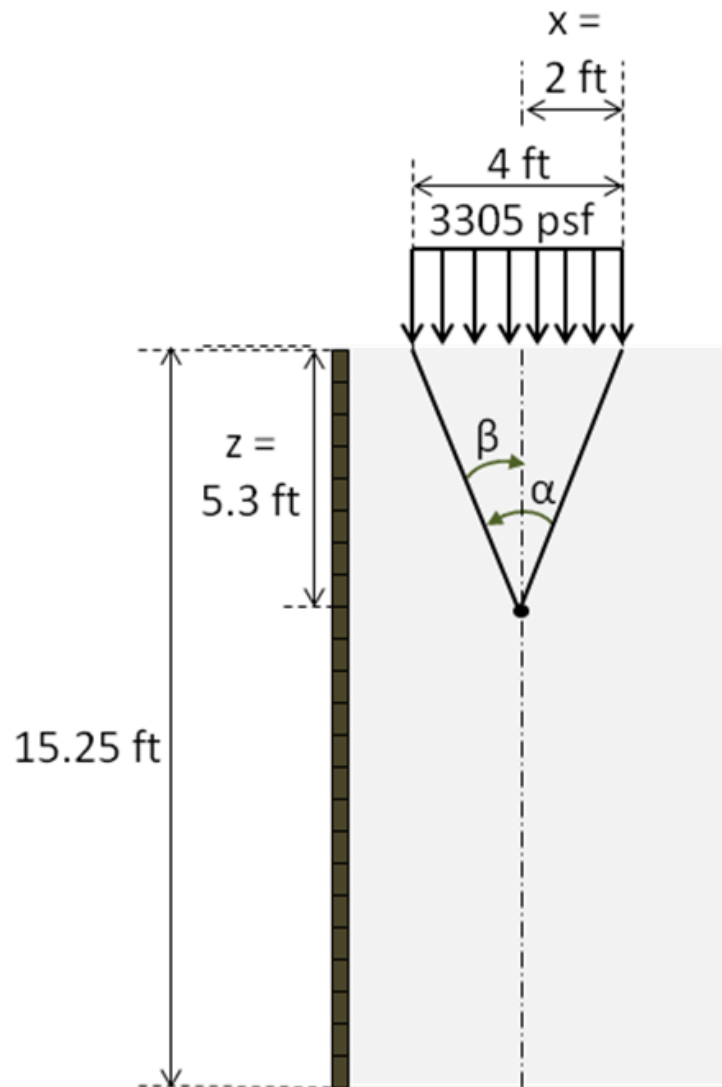

Figure 34. Illustration. Lateral pressure due to the bridge load.

Based on table 9, the required reinforcement strength does not exceed the allowable strength or the strength at 2 percent at any reinforcement layer. Therefore, no bearing bed reinforcement is needed; however, the minimum requirement is that the bearing bed reinforcement should extend through five courses of blocks. In actuality, six courses of block were chosen to extend the bearing reinforcement bed in this case (to a depth of 4 ft below the top of the wall). This was chosen to be conservative since this was the first bridge built with GRS technology.

Applying 4-inch spacing to the top six courses of blocks and 8-inch spacing for the remaining height of the wall, the required reinforcement strength was found (see table 10). The maximum required reinforcement is 716 lb/ft, which is less than the factored reinforcement strength of 1,371 lb/ft and the reinforcement strength at 2 percent. There should, therefore, be no issues with reinforcement strength in the abutment.

Table 10. Required reinforcement along height of wall.

z (ft)	$\sigma_{h,total}$ (psf)	T_{req} (lb/ft)
0.3	594	319
0.7	593	318
1.0	586	314
1.3	572	307
1.7	553	297
2.0	533	286
2.3	513	275
2.7	493	265
3.0	476	255
3.3	460	247
3.7	446	239
4.0	434	233
4.7	415	716
5.3	401	692
6.0	391	675
6.7	385	664
7.3	381	658
8.0	380	655
8.7	380	655
9.3	381	658
10.0	384	663
10.7	388	669
11.3	392	676
12.0	397	685
12.7	403	695
13.3	409	705
14.0	415	717
14.7	422	729

4.4.8 Step 8—Implement Design Details

All design details were considered. Since it was a skewed bridge, the bearing area of 3 ft was maintained along the length of the face wall. The bearing bed reinforcement schedule was also maintained across the abutment face due to the superelevation, as shown in figure 35.

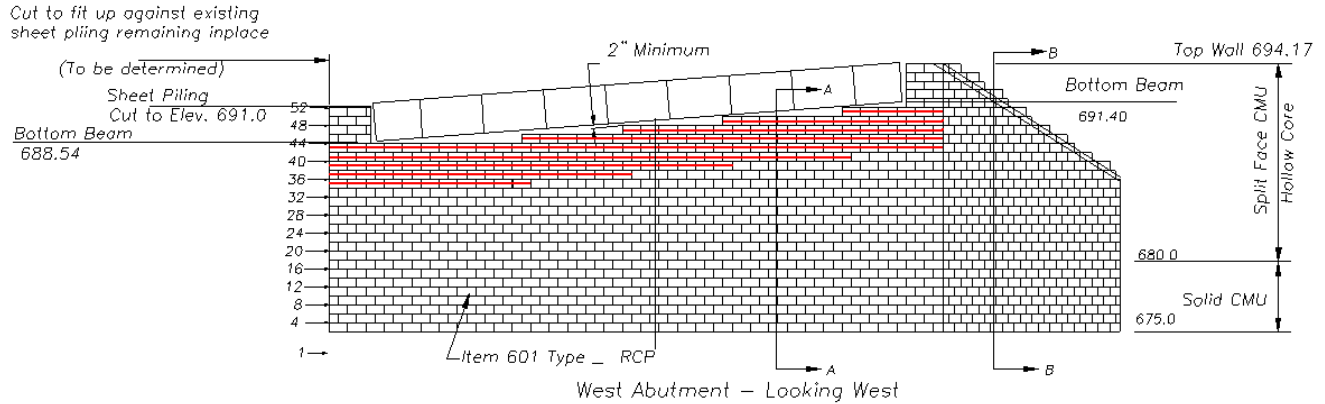

Figure 35. Illustration. Secondary reinforcement for superelevation at Bowman Road Bridge.

4.4.9 Step 9—Finalize Material Quantities and Layout

The amount of reinforcement necessary is based on the reinforcement schedule. Reinforcement material came in 12- to 18-ft-wide rolls. The number of facing blocks was determined from the height and length of the abutment and wing walls. The amount of backfill required was determined in a similar fashion. Once final quantities are established, it is a good rule of thumb to order at least 10 percent more to account for unforeseen conditions.

CHAPTER 5. SPECIAL REQUIREMENTS FOR HYDRAULIC AND SEISMIC CONDITIONS

5.1 INTRODUCTION

This chapter describes how extreme events such as scour, seismicity, or impact may alter the design of GRS-IBS.

5.2 HYDRAULIC DESIGN

When bridges are constructed to span a waterway, their foundations must be designed, detailed, and constructed in compliance with section 2.6 (Hydrology and Hydraulics) of the AASHTO *LRFD Bridge Design Specifications* or an FHWA Division Office-approved drainage or bridge manual.⁽⁹⁾ These provisions apply equally to both shallow and deep foundations.

GRS-IBS has been successfully used to build abutments near rivers and streams. However, assessing the potential impact of stream instability, scour, and adverse flow conditions is a vital consideration in the decision to use this technology. The potential for issues with stream instability, scour, and adverse flow conditions can lead to deep foundation bottom elevations or expensive countermeasures that could reduce the cost-effectiveness of GRS-IBS abutments. If the potential for abutment scour, contraction scour, long-term degradation, or channel migration is high, costly design considerations or countermeasures could be required. Other factors, such as channel instability and adverse flow conditions (skewed approach flow, highly contracted flow, high velocity flow through the bridge opening, etc.) at the bridge, could also result in costly design considerations or countermeasures to stabilize the channel against further instability. Any of these conditions might make it advisable to select an alternative bridge abutment technology.

A thorough hydraulic analysis, scour evaluation, and assessment of channel stability of a bridge design will include an appropriate estimate of the design flow, development of water surface profiles through the proposed opening, assessment of scour (abutment, contraction, and long-term degradation), and if necessary, the design of countermeasures to protect the bridge or stabilize the channel. FHWA and others have developed procedures to assist the engineer in performing these analyses, and these procedures should be followed for GRS-IBS design.^(5,14,15)

5.3 HYDRAULIC DESIGN CONSIDERATIONS

There are a number of important factors to consider when completing a thorough hydraulic design and scour evaluation of a bridge. The determination of a scour elevation based on the computed scour depth; the selection, design and installation of a scour countermeasure; and postconstruction inspection are important factors that must be adequately addressed. The following factors should be considered:

- **Scour depth:** The scour depth at an abutment is to be calculated as the sum of the depth of contraction scour and long-term degradation. The elevation of the design scour depth is to be calculated by projecting the elevation of the depth of scour from the lowest point in the channel to each of the abutments.

- Scour countermeasures:** When scour depth is calculated as described in this section, a designed scour countermeasure is included. Design scour countermeasures include riprap aprons, gabion mattresses, and articulating concrete blocks (see section 4.5.3). The purpose of installing a designed scour countermeasure is to prevent loss of soil from underneath a GRS abutment from scour that occurs at or near the abutment. Soil loss can reduce bearing capacity or lead to settlement, which can cause structural failure (see section 4.5.3). Figure 36 shows a cross section of a typical abutment riprap countermeasure recommended for smaller, more culvertlike structures (flow length through structure is longer than structure width). See HEC-23 for additional details regarding the specific requirements for the design and configuration of this countermeasure.⁽⁵⁾ Larger, more bridgelike structures (opening length is greater than the flow distance through the structure) must be evaluated for scour using the procedures outlined in HEC-18 and HEC-20 and use a designed countermeasure as outlined in HEC-23.^(14,15,5)

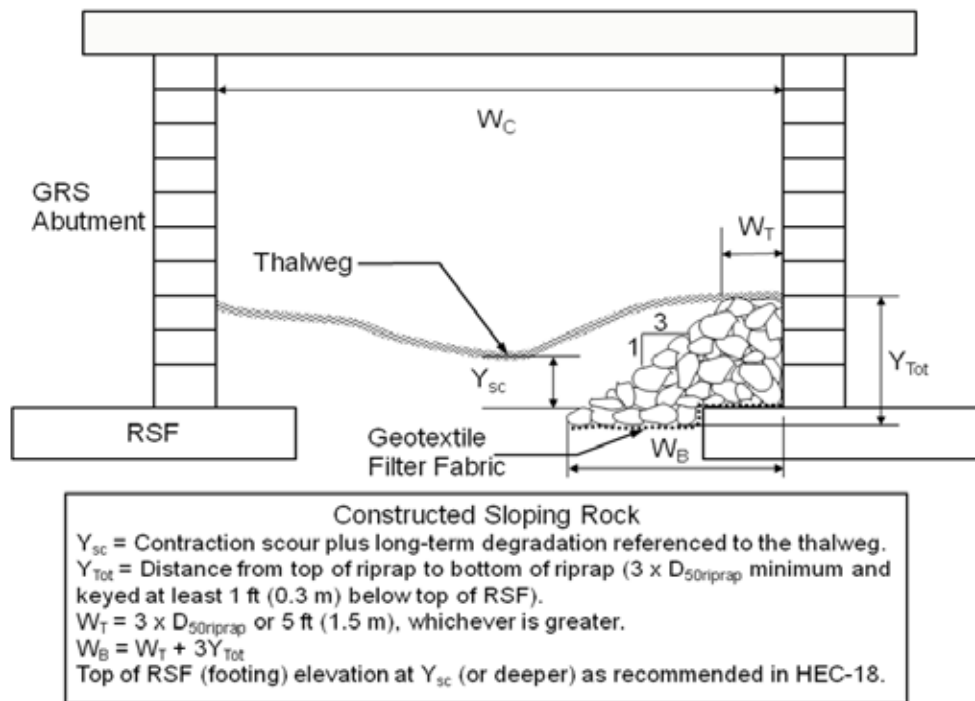

Source: HEC-23 Figure 18-10

Figure 36. Illustration. Typical cross section for sloping rock (adapted).⁽⁵⁾

- Inspection:** After construction, scour countermeasure condition and channel instability should be assessed during each regular bridge inspection and after extreme flood events. Any countermeasure failure or significant change in channel condition should be noted and scheduled for repair or stabilization. Without proper inspection and maintenance, a scour countermeasure may fail or a channel may become unstable, which can lead to undermining of an abutment. The FHWA's HEC-20 discusses approaches for evaluating channel instability, and HEC-23 discusses approaches for inspection and monitoring the effects of scour.^(15,5)

Another hydraulic consideration is drainage. The potential for unbalanced water pressure exists when a wall can become partially submerged by a flood or when surface drainage is not controlled. All GRS structures should include consideration for surface and subsurface drainage. Critical areas are behind the wall at the interface between the GRS mass and the retained fill, at the base of the wall, and any location where a fill slope meets the wall face. For example, the design needs to include provisions for surface drainage along the fill slope adjacent to the wing walls. Section 6.5 discusses drainage details.

5.4 SEISMIC DESIGN

External stability for seismic design will need to be checked for GRS-IBS just like with any other gravity structure. Design considerations for external stability and seismicity include increasing the base width of the wall and increasing the length of the reinforcement at the top of the wall. Additional bearing capacity and overall external stability is generally improved by increasing the base width of the wall. Additional stability is created by increasing the length of the reinforcement at the top of the wall or abutment. This integrated approach has also been shown to be beneficial because it keys the structure into the existing terrain, preventing the development of a failure plane along the cut slope, which can lead to progressive failure.

No seismic design requirements are necessary for the internal stability of GRS-IBS. Reinforced soil walls have been known to perform better than conventional retaining walls under seismic loading, as evidenced by observations of actual performance in strong earthquake events. (See references 16–19.) A National Cooperative Highway Research Program (NCHRP) study is being conducted to establish guidelines for the design and construction of GRS abutments under seismic loading.⁽²⁰⁾ As part of the NCHRP study, a 12-ft-high GRS abutment supporting a bridge load of about 1,000 kips was subject to sinusoidal motions on a shake table. No significant damage or movement was recorded until the acceleration was increased to 1.0 g, at which time base sliding between the GRS abutment and foundation soil became apparent. The superstructure would not have failed due to the deformation of the GRS mass at the 1.0-g acceleration. This experiment suggests that a GRS abutment is capable of withstanding at least low to medium earthquakes without any special provisions.

5.5 IMPACT EVENTS

There is limited information on vehicle impact against GRS-IBS. Typically, GRS walls along roadways are built behind a crash barrier. A niche function of GRS technology, however, is rock-fall protection. That application is not covered in this manual, but it serves to show that GRS is capable of withstanding considerable lateral and vertical impacts without failure or loss of serviceability.

CHAPTER 6. IN-SERVICE PERFORMANCE

6.1 INTRODUCTION

This chapter presents methods of evaluating the performance of GRS-IBS, including deformations, thermal movements, and scour monitoring. The performance of in-service GRS-IBS structures can be found in the synthesis report.⁽¹⁾ A distinctive feature in the design of GRS-IBS is that it works with settlement instead of resisting it to create a compatible connection between the approach and the road, providing a long-term solution to the bump at the end of the bridge. Reducing the bump at the end of bridge will improve the overall performance and serviceability of the bridge. This bump not only creates a chronic maintenance issue but also induces an amplification of LL on the superstructure, creating fatigue on bridge elements.

Recently, some owners have shifted their focus on the combined effects of corrosion and fatigue in the evaluation of a bridge's health. The design objective of IBS addresses these two critical durability issues by attempting to create a smooth, jointless, affordable bridge system. GRS-IBS was developed to meet the demand for the next generation of small, single span bridges in the United States as part of the FHWA's Bridge of the Future initiative and is built without many of the standard abutment components associated with a traditional bridge (e.g., approach slab, sleeper slab, traditional bridge bearings, joint details). The performance of the first series of GRS-IBS indicates that this method has considerable potential to advance the state of the practice.

6.2 DEFORMATIONS

The performance of nearly 20 bridges built with GRS-IBS has been an improvement on similar bridges built with conventional construction techniques. The GRS-IBS bridges have performed as well as the conventional bridges structurally and functionally in addition to eliminating the bump at the end of the bridge that often results from conventional construction. The suppression of the bump at the end of the bridge has been maintained for all GRS-IBS bridges that are in service. The first bridge constructed with the IBS method, the Bowman Road Bridge, has been in service since 2005. As of 2010, there has been no development of a crack in the asphalt layer from the road to the bridge.

The total settlement and deformation (and thus vertical strain) of the GRS abutment due to bridge load is recorded using either a standard survey level and rod system, as shown in figure 37, or an electronic distance measurement (EDM) survey referenced off a permanent survey pole and benchmarks. The precision of all survey measurements (both the survey level method and the EDM system) is ± 0.005 ft.

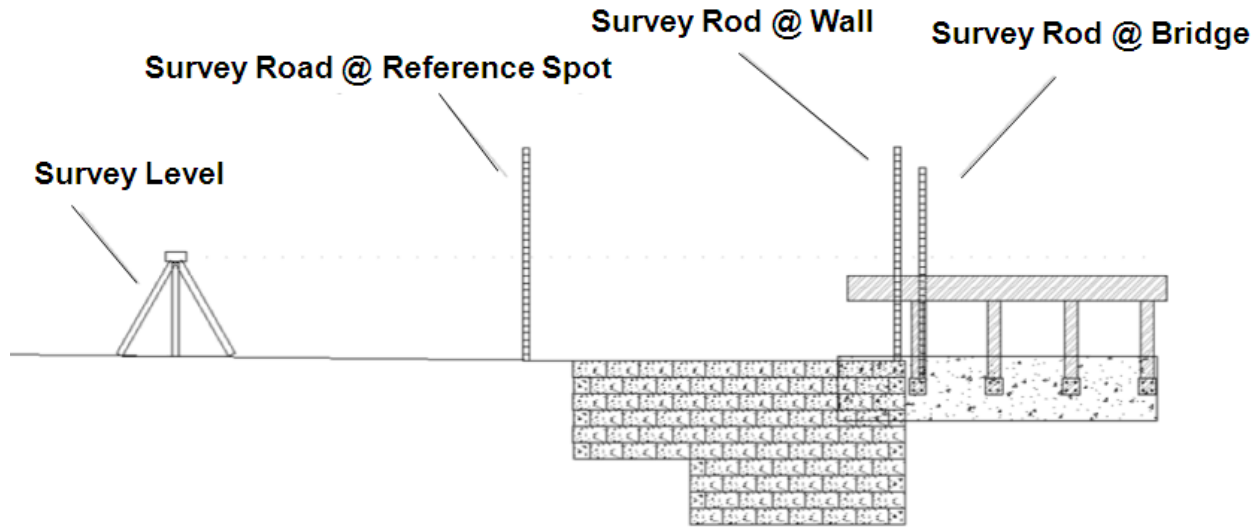

Figure 37. Illustration. Survey level method for superstructure and wall settlement.

Using either settlement measurement technique, the settlement is recorded for both the abutment face wall and the superstructure. The difference between the settlement measured on the abutment face wall and the superstructure is the vertical deformation within the GRS mass alone due to the bridge load. To determine secondary settlement (i.e., creep), plot settlement versus log-time.

For surveys where a survey level is used, bridge settlement should be measured at four locations (each corner of the bridge) to check for angular distortion and differential settlement. Wall settlement is recorded by the rod off the top of the CMU facing block adjacent to the superstructure, and superstructure settlement is measured with the rod off a guardrail hanger bolt (see figure 37).

For surveys with an EDM system, the total station is referenced off of a permanent pole embedded beneath the frost line and within accessible sight to both abutment face walls. Targets placed on the abutment wall face and the bridge beam or footing are then used to measure movement relative to the permanent pole. Figure 38 shows an example of this for the Tiffin River Bridge in Defiance County, OH. Lateral and vertical movement of the abutment wall face was measured using custom reflective survey targets, which are shown in the black circles in figure 38. Movement of the GRS abutment was measured using targets placed on the concrete footing itself, which are shown in the red circles in figure 38. The difference between the two readings (movement of the abutment and movement of the wall face) provides the compression of the GRS abutment alone, not including foundation settlement. Note that the permanent pole should be installed prior to placement of the steel girders on the CIP footings (see figure 39).



Figure 38. Photo. Location of survey targets on Tiffin River Bridge, Defiance County, OH.



Figure 39. Photo. Location of total station reference pole.

6.3 THERMAL CYCLES

Thermal cycles occur on every bridge structure due to sustained temperature variations. The severity of the expansion and contraction depends on the coefficient of thermal expansion of the bridge. However, observations of bridges built in moderate climates indicate considerable compatibility between the superstructure and the integrated approach, resulting in a smooth transition.

GRS-IBS accommodates movement through the integrated transition zone behind the beam ends. The road base is wrapped with geotextile and then compacted directly against the beam end. This process is described in detail in chapter 7. The wrapped face confines the soil and allows the beam to contract without the fill behind the beam ends sloughing off to fill the void. Because of this, excess pressures behind the beam during expansion are also avoided. The road base is not only wrapped vertically but also laterally to prevent lateral spread.

6.4 MONITORING FOR SCOUR

The riprap protection should be monitored during each bridge inspection or after an extreme flood. Any movement of rock should be noted and replaced to prevent scour from progressing and undermining the RSF or the abutment. In all current installations of GRS abutments, no problems have been reported. It should be noted that these installations have been built in non-scour-critical environments and with appropriate countermeasures, as recommend in current practice.⁽⁵⁾

An indicator of scour on an abutment face or wing wall can be achieved by using colored blocks on the bottom five to eight rows of the abutment. Solid blocks are recommended in the bottom rows as they are more likely to resist any impact of moving riprap, ice, or other abrasion associated with the normal water elevation. The solid colored blocks are also covered from view by the riprap. Any exposure of colored blocks could indicate movement or undermining of the riprap, requiring inspection and possibly remediation or repair to protect the RSF and abutment from scour.

CHAPTER 7. CONSTRUCTION

7.1 INTRODUCTION

GRS construction uses basic earthwork methods, primarily for excavation and compaction, along with sound general construction practices. The materials are readily available, which is a benefit of the generic nature of the system. This chapter provides guidance on most field-related scenarios. All methods that are presented have been field-tested and applied during the construction of GRS-IBS. The techniques outlined can be applied to efficiently construct the layered system and have been proven to quickly construct the GRS-IBS. The contractor will ultimately choose the methods most efficient for the site, the crew, and the equipment on hand.

The guidance outlined here applies to GRS structures, specifically abutments built with CMU blocks. This guidance can also be adapted to other GRS structures built with different facing systems.

GRS construction has two principal components: (1) logistics and (2) aspects associated with actual construction. Logistics occur after the final design and before construction, outlining a plan for implementation and control of the construction process. Even though building a GRS abutment is as simple as a row of facing block, a layer of well-compacted granular fill, and a sheet of reinforcement, the process will be hampered without adequate planning to ensure optimum flow and placement of material during the course of the project.

As a result, the single-sheet plan was devised to provide information on the reinforcement schedule and the facing block schedule. The single-sheet plan also contains information on the limits of excavation and details about assembly of the GRS structure. A second sheet may be necessary to detail quantities and construction notes.

This chapter conveys the importance of the following details as a means to rapid GRS construction:

- Careful attention to the first row of blocks. Since all other courses of block are built off the first row, it is essential to ensure that the bottom row is level and even for fast construction.
- Optimization of crew size and equipment for enhanced productivity. Too many laborers or excess onsite equipment can cause confusion and slow down the construction process.
- Allowing time for a labor crew to adjust to the construction of the GRS-IBS. Having each crew member do their part in one of three basic steps of GRS construction (laying a course of facing block, compacting a layer of granular backfill, and placing a layer of reinforcement) dramatically improves productivity.
- Establishing the central position of the excavator. Typically, it is best to limit movement of the excavator by locating it toward the back of the abutment, where it can both reach and place material without moving.

7.2 LABOR AND EQUIPMENT

7.2.1 Labor Requirements

A typical labor crew on GRS-IBS projects has consisted of about five workers: four laborers and an equipment operator (see figure 40). The equipment operator is central to the project and provides support to the labor crew. The equipment operator is responsible for shaping the excavation to facilitate construction of the RSF and the GRS abutment in addition to placing fill material and moving facing units into the work area. Typically, one member of the labor crew has the role of foreman and is responsible for layout of excavation limits, grades, alignment of wall face, placement of facing blocks, compaction of fill, placement of geosynthetic reinforcement, and other activities to streamline production and the flow of material to the job site.



Figure 40. Photo. Typical labor crew with centrally located track hoe.

7.2.2 Tool and Equipment Requirements

Specialized equipment is not required to construct GRS-IBS. Simple tools that are readily available and relatively inexpensive can be used. These include hand tools, measuring devices, and heavy equipment. The contractor may modify the included lists depending on the site, the crew, and the size of the IBS.

Typical hand tools include the following:

- Gravel rake (concrete spreader).
- Shovels (flat blade and spade).
- Heavy rakes.

- Broom to sweep top of blocks.
- Wisk broom.
- 2- to 3-lb sledgehammer and wood two-by-fours to align blocks.
- Heavy rubber mallet.
- Spade trowel.
- Razor knives or utility knives to cut reinforcement.
- Hand tamper with metal base plate.
- Chainsaw to cut reinforcement roll.
- Concrete saw.
- 5-gallon bucket.
- Block lifter.
- Standard concrete mixing and finishing tools.

Typical measuring devices include the following:

- Survey equipment.
- Laser level.
- String line to align blocks.
- 4-ft carpenter's level.
- Plum bob to check wall batter.
- Measuring tapes.
- Chalk line.

Typical heavy equipment includes the following:

- Walk-behind vibratory plate tampers (200 lb and 18 inches wide or larger).
- Track hoe excavator.
- Riding smooth drum vibratory roller (compacting 3.28 ft from wall face).

- Pallet forks for excavator (for moving CMU block in and out of work area).
- Trash pump and hose for dewatering foundation excavation.
- Backhoe (as needed for material staging).

7.3 SITE PREPARATION

GRS is built from the bottom up and generally from within the footprint of the structure. Staging and delivery of materials to the site should allow for continuous GRS construction and effective use of the space. Delivered material should be easily accessible to the excavator, which is the central piece of equipment. As shown in figure 41, the excavator is positioned inside the wall area for easy placement of fill, block, and other materials. Labor should be organized to assemble construction materials as needed on the work platform.



Figure 41. Photo. Cut slope of retained soil.

7.3.1 Site Layout

Site preparation begins with a survey of the bridge site to stake limits for the excavation. Reference stakes should be located in an area where they will remain undisturbed during construction of the base of the wall, usually about 5 ft from the excavation.

The base of the GRS abutment and wing walls should be constructed to within 1 inch of the staked elevations. The external GRS abutment and wing walls should be constructed to within ± 0.5 inches of the surveyed staked dimensions.

7.3.2 Excavation

All excavations should comply with Occupational Safety and Health Administration requirements.⁽²¹⁾ Excavation of the site involves shaping the slope for temporary slope stability, safety, and constructability. The temporary cut in the retained soil should be designed to accommodate movement of labor. The design of a temporary excavation needs to consider the loading imposed

by heavy equipment and the reach limits of the excavator. Figure 41 shows a typical cut slope in stiff clay. The excavation should include provisions for drainage with a sloped cut to facilitate the movement of water. Any open excavations that form a pit should be backfilled with crushed aggregate and compacted. Excavation also includes the clearing and grubbing of vegetation. In situations where the retained fill is stable, the volume of excavation can be limited to reduce the size of the GRS mass. In the case of an abutment application, this would form a horseshoe shaped excavation, as shown in figure 40 and figure 42.



Figure 42. Photo. Horseshoe-shaped excavation with native soil still intact in middle.

7.3.3 Placement of Abutment Behind Existing Substructure

In some situations, it may be beneficial to build GRS-IBS behind an existing substructure. Project feasibility, environmental considerations, and other factors need to be assessed before selecting this type of project layout. Building the bridge behind an existing substructure often requires the removal of the top part of the abutment walls to provide additional space for the width of the new GRS-IBS. Figure 43 through figure 45 illustrate this technique. Note that the design of the GRS-IBS will be the same whether it is built behind an existing abutment or not.



Courtesy of St. Lawrence County, NY

Figure 43. Photo. GRS-IBS built behind an existing concrete abutment.

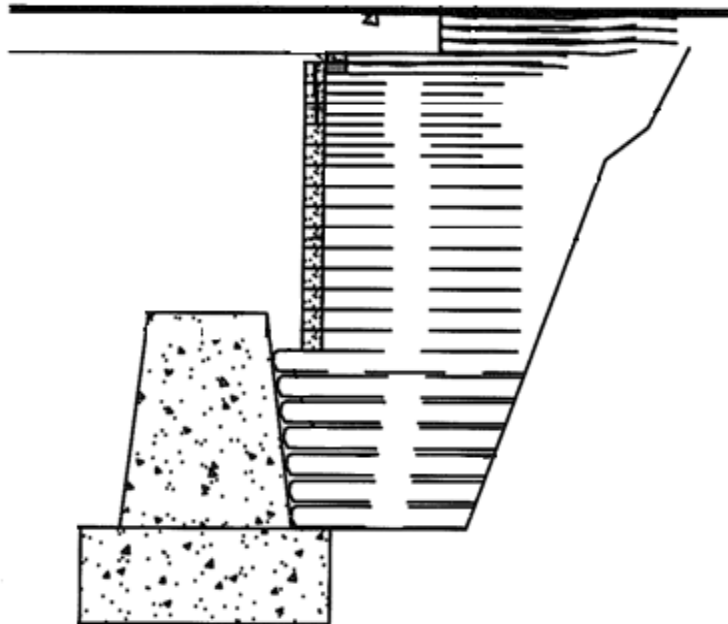

Courtesy of St. Lawrence County, NY

Figure 44. Illustration. Cross section of GRS-IBS built behind an existing concrete abutment.



Figure 45. Photo. Building the RSF behind an existing abutment.

7.4 RSF

The depth and footprint of the excavation for the RSF should be based on external stability, as described in chapter 4. The base of the RSF should be cut smooth. It should be excavated to uniform depth, and all loose, unstable material should be removed from the site (see figure 46). If the base of the excavation is left open, it should be graded to one end to facilitate the removal of any intrusion of water with a pump. If flooded, all water should be removed along with soft, saturated soils. The excavation should be backfilled as soon as possible to provide a suitable foundation and avoid adverse weather delays. The construction of the RSF can typically be completed in less than one day but is dependent on the size and depth of excavation, type of materials, equipment, and experience.



Figure 46. Photo. RSF excavation below stream level.

The base of the excavation should be compacted before construction of the RSF. This may require proof rolling, and any soft spots or voids should be backfilled with compacted fill material. Figure 47 shows the preparation of the RSF cut.



Figure 47. Photo. RSF cut preparation.

The RSF should be encapsulated in geotextile reinforcement placed perpendicular to the abutment face to protect it from possible erosion (see figure 48). The reinforcement sheets should be measured and sized to fully enclose the RSF on three sides: the face and the two wing wall sides. If the GRS abutment is adjacent to water, the reinforcement sheets should overlap, starting with the first layer on the upstream side of the RSF. All overlapped sections of reinforcement in the area of the RSF should be oriented to prevent running water from penetrating the layers of reinforcement. The first layer of reinforcement should be placed on the upstream side of the abutment with subsequent layers, if needed, overlapped a minimum of 3 ft on the downstream side. This prevents water from infiltrating the RSF. The wrapped corners of the RSF need to be tight and without exposed soil within the RSF to complete the encapsulation.



Figure 48. Photo. Encapsulation of fill in RSF.

Typical reinforcement spacing in the RSF is 12 inches. The reinforcement should be pulled taught to remove all wrinkles prior to placing and compacting the structural backfill. Fill should be placed from the face to the back to roll folds or wrinkles to the free end of the reinforcement layer.

The RSF should be constructed with structural fill, as specified in chapter 3. The structural fill is to be compacted in accordance with section 7.5 in compacted lifts not to exceed 6 inches (with two compacted lifts per each 12-inch layer). The first course of wall block sits directly on the RSF, as shown in figure 49, so it is important that the fill material is graded and level before encapsulating the RSF.



Figure 49. Photo. Placement of wall block on wrapped RSF.

While the base of a typical GRS abutment is built with solid CMU, damage can occur during the placement of channel rock protection or from other large pieces of concrete rubble that extend above the solid block zone. Riprap protection should be placed in a manner to prevent damage to the CMU wall face. Impact of large rock or concrete fragments during placement can crack the CMU block. Larger rocks should be uniformly distributed and placed firmly in contact with each other, with smaller rocks and fragments filling the voids between the larger rocks. This procedure often requires hand placement of smaller rocks to fill the voids. If any CMU block is damaged, refer to chapter 8 for repair procedures.

7.5 COMPACTION

Compaction of the backfill should be to at least 95 percent of maximum dry density according to AASHTO T-99. Backfill material containing fines should be compacted at a moisture content close to optimum (± 2 percent). Lifts of 8 inches should be compacted using vibratory roller compaction equipment. The facing blocks provide a form for each lift of fill. Other stiffness-based compaction control methods can be used. For open-graded fills, compact to non-movement or no appreciable displacement and assess with visual inspection.

Since the facing elements are not rigidly connected to the reinforcement, hand-operated compaction equipment (e.g., a lightweight mechanical tamper, plate, or roller) is required within 1.5 ft of the front of the wall face. It is very important for adequate GRS performance that the backfill is properly compacted. The top 5 ft of the abutment should be compacted to 100 percent of the maximum density according to AASHTO T-99.

Onsite compaction equipment should be selected to achieve the required density of the fill materials. Considering that compaction is critical to the success of the project, compaction equipment should be in good operating order for efficient use. In addition, backup equipment should be available to provide quality construction throughout the project and to avoid construction delays.

7.5.1 Compaction Procedure

Once fill is placed at the required thickness and graded, all areas behind the CMU block should be compacted to the required density. Any depression behind the facing block should be filled level to the top of the CMU block prior to compaction.

Compaction directly behind the CMU block should be performed in a manner that maintains wall alignment while improving the density of fill behind the block. This can be achieved in the following ways:

- Placing a fill lift directly behind the CMU block face and rodding or foot tamping along the row of CMU block while exerting downward pressure on the block to prevent lateral movement. For multiple lifts, the top lift height is slightly higher than the block to compensate for compression of the fill during compaction.
- Using a lightweight vibratory plate compactor directly behind the CMU block while exerting downward pressure on the block to prevent lateral movement.
- Using larger vibratory compactors for the remainder of the fill area 3 ft from the face of the GRS wall. Check for outward block movement and adjust accordingly.

The most common compaction QC tool is the nuclear density gauge. Other instruments are also available for compaction control such as the Clegg hammer, the soil stiffness gauge, or the falling weight deflectometer. These devices are typically used by correlating their measurements to soil density and moisture content. Method-based compaction specifications can also be used. For open-graded fills, compact to non-movement or no appreciable displacement and assess with visual inspection.

7.6 REINFORCEMENT

Generally, the length of the reinforcement layers will follow the cut slope, as shown in figure 50. While the reinforcement layers in the GRS abutment can be any geosynthetic, the RSF and integrated approach should be constructed and encapsulated with a geotextile to confine the compacted granular fill. The geosynthetic should be placed so that the strongest direction is perpendicular to the abutment face, as shown in figure 51. Where the roll ends, the next roll should begin. Overlapping between sheets is required. The geosynthetic reinforcement should extend between layers of CMU block to provide a frictional connection. The geosynthetic reinforcement

should cover a minimum of 85 percent of the top surface of the CMU block; any excess can be removed by either burning with a propane torch or cutting with a razor knife.

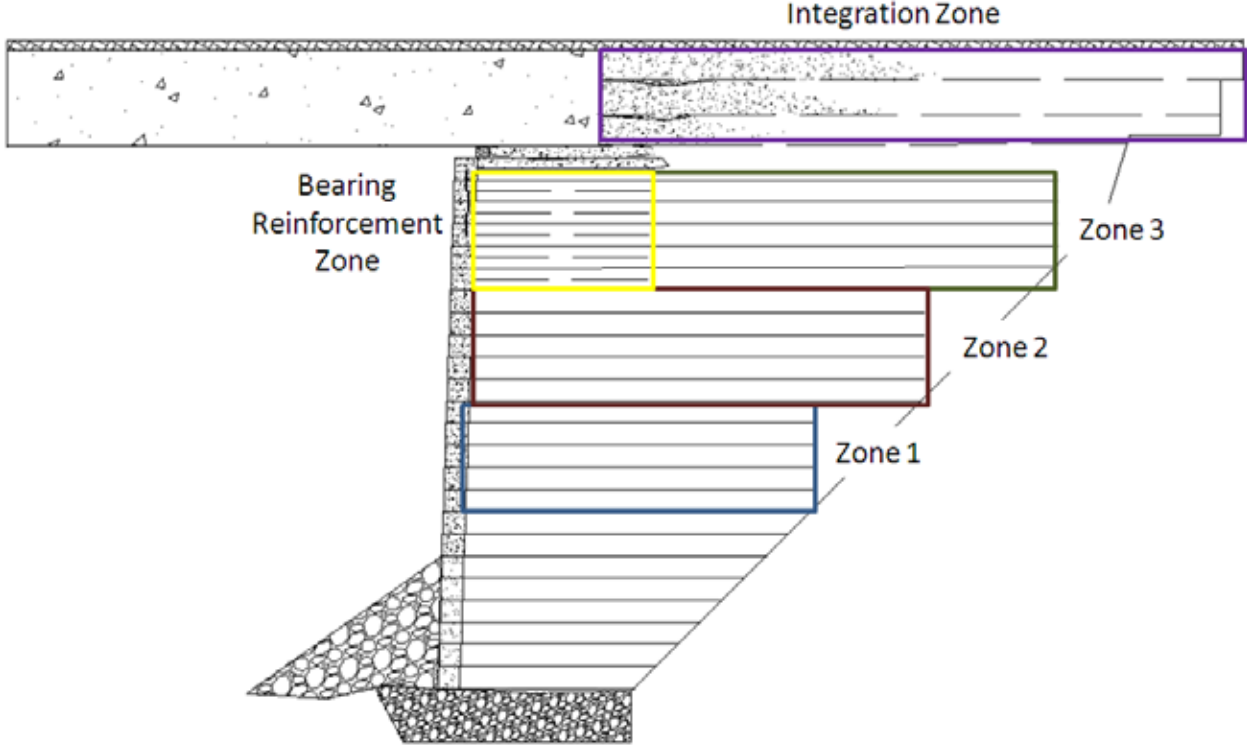

Figure 50. Illustration. Typical reinforcement zones.



Figure 51. Reinforcement rolled out parallel to wall face.

After the geosynthetic is rolled out, it should be laid so that it is taut, free of wrinkles, and flat. The geosynthetic can be held in place with the fill. Placement of fill should be from the wall face backward to remove and prevent the formation of wrinkles in the geosynthetic. A conscious effort should be taken during placement of fill to prevent the development of wrinkles.

Splices of reinforcement can occur without overlap. Splice seams should be staggered to avoid a continuous break in the reinforcement throughout the GRS structure. All splice seams should run perpendicular to the wall face.

Overlaps of adjacent geosynthetic should be trimmed where they are in contact with the surface of the CMU block to avoid varying geosynthetic thicknesses between the CMU block. Any seams in the geosynthetic should be staggered with each successive layer of the GRS abutment. All seams between adjacent sheets of geosynthetic located in the area beneath the footprint of the bridge seat should be perpendicular to the abutment wall face.

7.6.1 Operating Equipment on Geosynthetic Reinforcement

Driving should not be allowed directly on the geosynthetic reinforcement. Place a minimum 6-inch layer of granular fill prior to operating any vehicles or equipment over the geosynthetic reinforcement. Rubber-tired equipment may pass over the geosynthetic reinforcement at speeds less than 5 mi/h. Skid steers and tracked vehicles can cause considerable damage to the geosynthetic. On one occasion, a track hoe operating on a GRS structure turned and pulled the fabric causing deformation to the wall face. For this reason, it is recommended to restrict the use of these vehicles on GRS structures. If absolutely necessary, use may be permitted provided no sudden braking or sharp turning occur and a minimum 6-inch cover is placed.

7.6.2 Bearing Reinforcement Bed

The bearing reinforcement bed provides additional strength in the upper GRS wall layers directly beneath the bearing area of the superstructure. These reinforcement layers are not sandwiched between two consecutive rows of block but are placed behind the CMU block at 4-inch spacing. This 4-inch reinforcement spacing is generally placed in the top five layers of the GRS abutment or as determined by design (see chapter 4).

Bearing bed reinforcement spacing in superelevated abutment walls requires additional planning. The 4-inch reinforcement spacing needs to be in place for the top five courses of block at the lowest elevation across the abutment wall (see figure 50 and figure 52). The reinforcement schedule will guide field personnel in the proper placement of the geosynthetic along a wall block course.

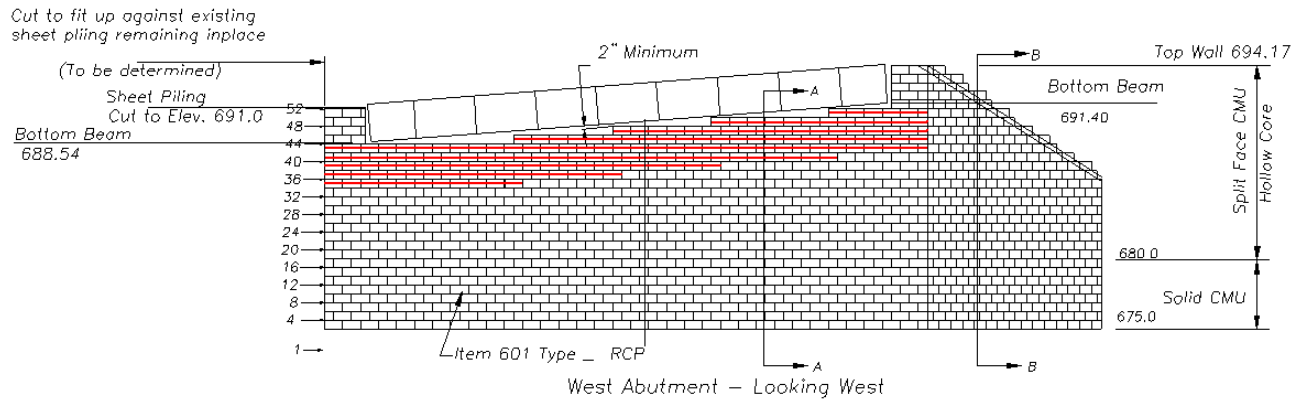

Figure 52. Illustration. Superlevation reinforcement schedule.

7.6.3 Superlevation

The reinforcement layers become stair-stepped in the upper wall layers as the superlevation of the abutment is constructed (see figure 53). The reinforcement terminates along the angle surface of the superlevation. The GRS wall reinforcement schedule should show the termination of each layer of reinforcement across the abutment wall from low to high elevation (see figure 52).



Figure 53. Photo. Superlevation reinforcement layers.

7.7 WALL FACE

This manual focuses on the use of CMU for the wall facing; however since GRS is internally stable, any facing elements can be used in construction. For flexible facings other than the recommended CMU block (including wrapped, timber, natural rock, or welded wire basket formed facing), other construction guidelines may need to be followed. These are outlined by Wu et al.⁽²²⁾ The design guidelines for GRS-IBS, however, remain the same as those in this manual.

7.7.1 Leveling Course

Setting the first course of facing block level and to grade is critical in maintaining wall alignment for the entire height of the abutment. Typically, the first course is placed on top of the RSF, directly on the geotextile. However, due to the large aggregate size of the RSF fill material, a thin leveling layer of fine aggregate can help set the CMU blocks to grade and prevent them from rocking. The leveling layer should be kept to a minimum thickness, no more than 0.5 inches. If the leveling layer exceeds this thickness and there is the potential for water to erode and undermine the aggregate, mortar or grout should be placed in the gap between the RSF and the first course.

7.7.2 Setting the CMU Block

CMU block wall construction should begin at the lowest portion of the excavation with each layer placed horizontally, as shown on the plans. Each layer should be constructed entirely before beginning the next layer. A stretcher or running bond should be maintained between courses of block so that the joints between the blocks are offset with each row.

If a designed scour countermeasure such as a riprap apron is used, a geotextile filter fabric should be placed under the apron and anchored between the first and second courses of CMU block.

Since the CMU blocks are dry stacked without mortar, it is important to avoid cracking the block and to maintain a horizontal uniform elevation by sweeping the top surface of the block clean of debris and fill material prior to the placement of the next layer of geosynthetic and CMU block. Gravel material between layers of block creates point loads that can cause cracks. Also, gravel material between the blocks causes them to rock, making it difficult to secure a good fit.

When setting a course of block, each block should be placed tightly against the adjoining block, preventing gaps from which fill material can escape. Before proceeding to the next layer, it is often useful to walk along the top of the blocks to easily identify a poorly seated block.

In order to avoid cutting a block when the CMU block schedule shows the wall terminating with half a block, a full CMU block can be turned 90 degrees, placing the 8-inch width toward the face. This typically occurs at the termination of a wing wall. The end block that forms the termination does not have to be a corner CMU (with two finished sides) because the ends of most wing walls are embedded into the fill slope.

7.7.3 Wall Face Alignment

When placing and compacting fill behind the CMU block, it is sometimes necessary to set the block back about 0.5 inches to allow for lateral outward movement of the CMU block during compaction. It should be noted that each combination of wall facing and backfill reacts differently during the compaction process, and adjustment of the setback distance between block courses should be performed as needed to maintain the necessary batter.

The vertical GRS wall should be checked for plumbness at least every other layer, and any deviations greater than 0.25 inches should be corrected. Before placement of the backfill, every other row of block alignment should be checked with a string line referenced off the back of the facing block from wall corner to corner (see figure 54).



Figure 54. Photo. Checking block alignment with string line reference from back of block.

If CMU blocks become displaced during construction, they can often be hammered back into position using a 3-lb sledgehammer and a block of wood as protection. If the CMU block is excessively out of alignment, the fill material needs to be excavated, the CMU block repositioned, and the fill material replaced and recompact.

7.7.4 Block Alignment for Battered Walls

Block alignment for battered walls is similar to that for vertical walls. In abutment situations where the face wall turns to form the wing wall, however, it is necessary to trim blocks on either end to account for the reduced wall length. All cuts should be performed to maintain the standard running or stretcher bond between the rows of dry-stacked blocks, with the vertical joints of each course midway between those of adjoining courses.

In special situations, negative battered walls have been constructed when the top area needs to be greater than the bottom, as in the case of road widening shown in figure 55. The negative batter can be created by offsetting the CMU block by a measured amount in consecutive wall layers then filling and compacting as specified.



Figure 55. Photo. Negative batter wall face.

7.7.5 Superelevation

When the plan shows a superelevation for the bridge, the top courses of CMU beneath the superstructure should be trimmed to match the elevation difference and clear space across the abutment (see figure 56). This will produce a sloped face wall and aid in construction of the beam seat. One method is to snap a chalk line along the back of the block at the superelevation slope. A carpenter's angle finder can also be used to mark the cut.



Figure 56. Photo. Blocks trimmed to match superelevation.

7.7.6 Wall Corners

Right-angle wall corners, as shown in figure 57, are constructed with CMU corner blocks that have architectural detail on two sides, providing an aesthetic finish. Facing wall and wing wall courses should be staggered to form a tight, interlocking, stable corner.



Figure 57. Photo. Right-angle wall corner.

Walls with angles larger or smaller than 90 degrees require additional effort. The corner blocks need to be cut to form the angled face. As a result, a vertical seam or joint is formed at the corner (see figure 58). Corners with vertical seams may have open block joints, making it prudent to fill the corner blocks with a concrete mix and install bent rebar to close and connect the seam at each course of block, as shown in figure 59. This procedure secures the two faces and prevents compaction-induced separation during construction of subsequent GRS layers. It may also be used wherever added strength at the wall corner is desired.



Figure 58. Photo. Vertical seam in wing wall.



Figure 59. Photo. Rebar installed in vertical seam prior to grout.

7.7.7 Top of Facing Wall

The top three courses of CMU block in the abutment are susceptible to movement simply from not having the weight of successive layers holding them in place. To prevent displacement, the hollow cores of the top three courses of CMU blocks are filled with a concrete wall fill and pinned together with No. 4 rebar, preferably epoxy-coated and embedded with a minimum 2-inch cover (see figure 60).



Figure 60. Photo. Connecting the top courses of blocks.

To grout and pin the top of the wall, the reinforcement between the top two courses of CMU block needs to be removed to open the core for placement of concrete wall fill and a 20-inch-long No. 4 rebar dowel, preferably epoxy-coated with 2-inch cover (see chapter 3). This can be accomplished either by cutting the reinforcement with a razor knife or by burning the reinforcement.

The concrete wall fill is placed in two steps. After the block void is filled with concrete to the top of the block and the steel rebar is inserted, a thin layer of the same concrete mix is placed on top of the block to form the coping cap, as shown in figure 61 and figure 62. The coping is then hand-troweled either square or round and sloped to drain. A wet-cast cap is more durable than a dry-cast cap and eliminates the need to furnish and install a separate cap unit.



Figure 61. Photo. Rounded coping cap.



Figure 62. Photo. Square coping cap.

Once the top of wall has been grouted and pinned, care should be taken to avoid any construction activity that may pull on the top layer of reinforcement. The frictional connection between the block is strong, and when courses are pinned together, the entire grouted wall face can be pulled out of alignment.

7.8 BEAM SEAT

The beam seat is constructed directly above the bearing bed reinforcement zone. The superstructure is then positioned on top of the beam seat, as shown in figure 63 and figure 64. The purpose of the beam seat is to ensure that the superstructure bears on the GRS abutment and not the wall facing block and to provide the necessary clear space between the superstructure and the wall face. Typically, the clear space is 3 inches, or 2 percent of the abutment height, depending on the required design (see chapter 4).



Figure 63. Photo. Box beam placed on beam seat.



Figure 64. Photo. Detail view of box beam placed on beam seat.

In general, the thickness of the beam seat is approximately 8 inches and consists of two 4-inch lifts of wrapped-face GRS. Remember, before construction of the beam seat, the cores of the CMU blocks on the abutment wall face must be pinned with No. 4 rebar and filled with concrete wall mix (see figure 65).



Figure 65. Photo. Bearing area block grouted prior to beam placement.

7.8.1 Beam Seat Procedure

Once the block elevation beneath the bearing area is established and the hollow cores are filled with grout, the beam seat is ready for construction. The following steps should be used:

1. Place precut 4-inch-thick foam board on the top of the bearing bed reinforcement. Sometimes, a thin layer of backfill may be necessary beneath the foam board for grading purposes and to ensure the proper clear space height and drainage (crown in bridge) (see figure 66). The foam board should butt against the back face of the CMU block. The exposed edge of the foam board helps form the nose of the reinforcement wrap across the length of the bearing area.



Figure 66. Photo. Foam board and 4-inch block assembly to form beam seat.

2. Set 4-inch solid concrete blocks on top of the foam board across the entire length of the bearing area (see figure 67). The back edge of the top CMU face block holds the 4-inch concrete block in place during compaction. Note that the distance between the top of the grouted CMU block and the top of the beam seat (the clear space) is the distance the beams can settle before bearing on the facing blocks.



Figure 67. Photo. 4-inch concrete block on top of foam board against top CMU face block.

3. Use the first 4-inch wrapped layer of compacted fill as the thickness to the top of the foam board (see figure 68).



Figure 68. Photo. First 4-inch wrap butted against foam board.

4. Place the second 4-inch wrapped layer of compacted fill to the top of the 4-inch solid block, creating the clear space as shown in figure 69. The top of this layer controls the beam elevation, and should therefore be carefully compacted and graded.



Figure 69. Photo. Top 4-inch wrap butted against 4-inch solid block.

5. Before folding the final wrap, it may be necessary to grade the surface aggregate of the beam seat slightly high, to about 0.5 inches, to aid in seating the superstructure and to maximize contact with the bearing area.

7.8.2 Setback

The setback is the distance between the back of the facing block and the front of the beam seat. This distance can be established during construction of the beam seat and placement of the block and foam board used to form the beam seat wrap. The setback distance is usually 8 inches but can be greater.

7.8.3 Aluminum Flashing

The aluminum flashing drip edge is installed prior to setting the bridge beams and is placed in between the bottom of the beams and the foam board. The flashing is held in place by the pressure of the beams on the compressible foam board (see figure 70). The length of the flashing should extend beyond the outside edge of the bridge beams and be trimmed to fit against the parapets.



Figure 70. Photo. Aluminum flashing (drip edge) between beams and top of CMU block.

7.8.4 CIP or Precast Footing

For GRS-IBS built without adjacent concrete beams, a CIP or precast footing may be necessary, as with steel beams or spread girders (see figure 71).



Figure 71. Photo. Steel girder on CIP footing.

7.9 PLACEMENT OF SUPERSTRUCTURE

Prepare the beam seat as described in section 7.8.1. The grade of the beam seat will control the final elevation of the bridge.

7.9.1 Crane Position on GRS Mass

The crane used for placement of the superstructure can be positioned on the GRS abutment provided the outrigger pads are sized within the capacity of the GRS mass. The outrigger pads should be sized for 4,000 psf near the face of the abutment wall with greater loads able to be supported with increasing distance from the abutment face (see figure 72).



Figure 72. Photo. Outrigger pads near wall face.

7.9.2 Reinforcement of Beam Seat

An additional layer of reinforcement should be placed between the beam seat and concrete or steel beams to provide additional protection of the beam seat (see figure 73). The additional layer of reinforcement may decrease the sliding resistance between the superstructure and the beam seat.



Figure 73. Photo. Additional reinforcement under beam.

7.9.3 Setting Superstructure on Beam Seat (Without CIP Footing)

Since the bearing surface is aggregate under a layer of geosynthetic reinforcement, it is important to set beams square and level. They should never be dragged over the beam seat surface, which

could create the potential for an uneven bearing area or a void under the beam, producing uneven bearing stresses between bridge elements.

7.9.4 Wing Walls and Parapets

Wing walls and parapets are constructed after the superstructure is set. The CMU block in the parapet wall should be trimmed or saw cut for a custom fit against the beam edge to prevent the loss of fill material. Figure 74 and figure 75 show the construction of the parapet against the superstructure. If the gap between the superstructure and the facing block is difficult to fill using thin slices of cut block, a mortar mix should be used to close the space.



Figure 74. Photo. Parapet and wing wall construction, view 1.



Figure 75. Photo. Parapet and wing wall construction, view 2.

7.10 APPROACH INTEGRATION

Proper approach construction at the road and superstructure interface is essential to minimizing settlement in front of the bridge beams and eliminating the bump at the end of the bridge. This is accomplished by compacting and reinforcing the approach fill in wrapped geotextile layers and blending the integration zone with the approach road base course. The material for the integration zone should be well-graded, as outlined in chapter 3.

Once the superstructure is in place, the approach to the bridge can be constructed using the following steps:

1. Trim a geotextile reinforcement sheet to provide the planned length after it is wrapped, and place it behind the beam end (see figure 76). The width of the sheet should allow for wrapping of the sides after the fill layer is placed and compacted. Wrapping of the sides prevents lateral migration of the fill.



Figure 76. Photo. Placing reinforcement.

2. Place a 6-inch lift of fill and compact, per compaction specifications for road base (see figure 77). Add a secondary layer of reinforcement on top of the 6-inch lift, and then place another 6-inch lift of fill and compact (see figure 78). Fold back the reinforcement sheet to wrap the compacted fill layer and smooth wrinkles (see figure 79).



Figure 77. Photo. First 6-inch fill lift.



Figure 78. Photo. Secondary reinforcement sheet.



Figure 79. Photo. Completed wrapped approach layer.

3. Repeat these steps until approximately 2 inches from top of beam grade, as shown in figure 80.



Figure 80. Photo. Second 6-inch fill lift.

Multiple sheets can be used along the width of the approach, as long as all seams are kept perpendicular to the beam ends. The typical wrap reinforcement spacing is 12 inches, with intermediate layers spaced at 6 inches and compacted in 6-inch lifts. However, in the case of beams with a reduced depth, the spacing of the wrapped layers may need to be reduced and the intermediate layers eliminated. The top wrap fold should increase in length with each successive wrapped layer until the fill is 2 inches below the bridge grade.

7.10.1 Wrapped Reinforcement Layers on Sides

If lateral spreading of the fill in the integrated approach will be an issue (e.g., wing walls are not sufficient to confine the fill at the sides), the reinforcement sheets comprising the wrapped layers should be folded over along the sides and perpendicular to the bridge (see figure 81).



Figure 81. Photo. Completed approach fill.

7.10.2 Preloading

In some situations, it might be beneficial to preload the abutment before paving to minimize postconstruction deformation or settlement within the GRS mass. A simple method of preloading can be achieved by parking fully loaded trucks on the bridge for several days before placement of the asphalt pavement.

7.10.3 Paving

The top layer of reinforcement should be kept approximately 2 inches below the beam grade. This will allow a layer of aggregate cover to be placed to protect the reinforcement from contact with hot mix asphalt.

When GRS-IBS is built with adjacent precast concrete beams, a layer of paving fabric is extended over the beams onto the approach way. Extending the paving fabric 3 ft over the beam approach interface is recommended. This is necessary to bridge the gap and provide an interface to accommodate thermal movement, minimize surface water infiltration, and prevent cracks in the road. Note that paving fabric is already used on top of the beams as a barrier to water infiltration and to absorb stresses to minimize reflective and fatigue cracking of the new asphalt surface layer.

7.10.4 Guardrail Post

Steel H posts are recommended for any railing that is driven through the reinforcement. It is also possible to drill through the GRS mass with an auger to set other types of posts.

7.11 SITE DRAINAGE

The GRS-IBS construction area should be protected from surface runoff during the project. Critical areas are behind the abutment wall at the interface between the GRS abutment and the retained fill, at the base of the abutment, and at any location where a fill slope meets the wall face. Design needs to include provisions for surface drainage along the fill slope adjacent to the wing walls. Provisions for drainage should also be included at the boundary of the wing walls and the fill slope. Long walls built along variable elevation or abutment wing walls are often stepped to reduce excavation. In these situations, the termination of wall steps should be sufficiently embedded to prevent problems with erosion. The drainage swell or channel should be separated from the wall to avoid flow directly against the wall face.

Site preparation for drainage should include the following:

- **Grading:** The site should be graded every night in anticipation of precipitation to avoid saturation of soil.
- **Diversion trenches:** An alternative to grading is placing diversion trenches around the perimeter to divert water.
- **Compaction of loose soil:** Any loose soil placed to construct GRS should be graded and compacted before stoppage of work for the day. Also, onsite stockpiles of fill material containing fines should be protected from excess precipitation.

CHAPTER 8. IN-SERVICE INSPECTION, MAINTENANCE, AND REPAIR

8.1 INTRODUCTION

A key feature of GRS-IBS is that it has fewer parts than conventional bridges and abutments and should therefore need less maintenance. Like other bridges, the main components are the superstructure and the substructure. The superstructure is the same as a conventional bridge and should have the same protocol for inspection, rating, maintenance, and repair. IBS is also somewhat similar to an integral abutment in how the ends are embedded in the approach. A difference is that the IBS is embedded in compacted gravel, whereas an integral abutment is encased in concrete. Both bridges are designed without a joint to limit the effect of water at the beam ends for improved durability.

At the time of this report, nearly 30 GRS-IBS bridges had been built for local or off-system service, with the oldest built in 2005. None of the bridges show any signs of distress. All indications are that GRS-IBS works well in the local road environment, suggesting that the long-term performance of this system is adequate. In addition, IBS has fewer components and is designed for a smooth transition, thereby reducing impact loads (a major contributor to fatigue of the superstructure). This promise of improved performance, however, does not mean that the bridge system is immune to the common problems of conventional systems. This chapter focuses on potential requirements unique to this IBS and other components associated with the integrated approach.

8.2 IN-SERVICE INSPECTION

Both superstructure and substructure elements should be included as part of the visual inspection process. As previously indicated, the superstructure is similar to a conventional bridge and therefore has a similar procedure for inspection. The following elements should be included as part of the inspection of the IBS substructure:

- **Pavement:** If the bridge has asphalt pavement, check for a transverse crack, shoving, or separation at the approach end wall interface.
- **Approach:** Check the approaches for vehicle rideability and smoothness.
- **Parapet walls:** Check the interface between the beams and the parapet wall for separation or shifting.
- **Beam ends:** Check embedded beam ends for corrosion (i.e., rust stains) at the beam bases.
- **Scour:** Monitor GRS walls built adjacent to a water channel for scour. Riprap or other appropriate countermeasures should be monitored at each bridge inspection or after an extreme flood event. Any movement of rock should be noted and repaired to prevent scour from progressing and endangering the RSF or the abutment. No problems have been noted in installations of GRS abutments even after sequential flooding events. An indicator of scour on an abutment face or wing wall can be achieved by using colored blocks on the bottom five to eight rows. Solid blocks are recommended at the bottom, as they are more likely to resist any impact of moving riprap, ice, or other abrasion

associated with the normal water elevation. The colored solid blocks are also covered from view by the initial riprap, and any exposure of colored block during inspection serves as a visual check for movement or undermining of the riprap, indicating a need for remediation or repair to protect the RSF and abutment from scour.

- **Drainage:** All GRS structures should include consideration for surface drainage. Check the critical drainage paths where the fill slope meets the wing walls leading to the base of the wall. It is imperative that the wing walls have sufficient embedment to prevent erosion due to roadway runoff.
- **Wall face cap:** Inspect the coping for cracks.
- **Modular blocks:** For GRS walls built with modular facing blocks, check for the following:
 - Cracked blocks.
 - Separated blocks.
 - Block durability problems. Refer to Chan et al. for more information about block durability due to freeze thaw, spalling, and efflorescence.⁽²³⁾
- **Guardrail:** Inspect traffic barriers for damage.
- **Wall face:** Inspect wall faces for excessive lateral movement or settlement.
 - Lateral deformation can be checked visually or with a plumb bob referenced from known points from the top of the wall to the bottom.
 - Visual inspection for wall settlement can be achieved by checking for distortion between the horizontal courses of block.
- **Clear space:** Inspect, measure, and record the distance from the top of the wall face to the base of the superstructure beam for any settlement within the GRS abutment mass. A clear space must be maintained throughout the life of the bridge to prevent loading on the facing elements.
- **Drip edge:** Inspect any drip edge detail at the top of the wall beneath the beam for water diversion.
- **Burrows:** Inspect and remove any animal burrows adjacent to the walls.

8.3 MAINTENANCE

If properly designed and constructed, GRS-IBS should need minimal maintenance because it has fewer parts (e.g., no approach slab, sleeper slab, CIP parapet walls, bridge bearings, or joint details). Since the bridge superstructure is built with common materials, general maintenance should be similar to that of a conventional bridge system. Maintenance duties might include the following:

- Sealing of a pavement crack, particularly one forming at the beam approach interface.

- Stabilization of drainage ditches to prevent erosion along the wing wall.
- Removal of vegetation growth from the wall face unless it is part of the design.
- Sealing of any gaps in the facing large enough to allow for a loss of fill.

8.4 REPAIR

This section includes tips and suggested methods of repair in the event of damage to the GRS abutment wall face. Damage can occur as result of impact, unforeseen scour, or poor wall face durability. Since a GRS abutment is internally supported, the face is not considered a structural element. However, its integrity is important to ensuring long-term performance of the GRS abutment.

The following are repair procedures for potential problems:

- **Damage to a few hollow-core blocks within the face of the wall:** Chip out the face of the damaged block and replace it with the face of another block. The face piece should be cut slightly smaller and be secured with mortar.
- **Repair of deteriorating facing blocks or scour damage:** Although there is no case history for this, shotcrete can be used to repair the face of a modular block wall. Figure 82 shows a GRS wall built with CMU blocks being used to repair a failed MSE wall. Figure 83 shows the same CMU covered with shotcrete. Note that drains were installed at the base of the wall to facilitate the flow of water from the GRS abutment. In some situations, it might be necessary to install vertical strip drains in the face of the GRS wall before applying the shotcrete.



Figure 82. Photo. Use of GRS wall to repair damaged MSE wall.



Figure 83. Photo. CMU GRS wall with a shotcrete face.

- **Damage to the top rows of CMU block:** Figure 84 and figure 85 show a GRS wall before and after the repair of a rock-fall impact. The repaired section is set slightly back from the original wall alignment. To repair this wall, the boulder was removed, and each soil layer within the damaged zone was excavated. To access the fill, the fabric layers were cut perpendicular to the face and peeled back enough to access all the reinforcement layers within the damaged zone. This process was repeated until the damaged zone was exposed. The exposed zone was rebuilt using the 1-2-3 method explained in chapter 7, one layer at a time, from the bottom up. In areas where the reinforcement was excessively damaged, new reinforcement was spliced in to reestablish the frictional connection. The top courses were then pinned and grouted.



Figure 84. Photo. GRS wall damaged by large sandstone boulder.



Figure 85. Photo. Repair of a GRS wall after damage caused by rock fall.

- **Excessive settlement of the beam seat:** While this has not been observed, it is possible that the superstructure could experience excessive movement either due to compression of the GRS abutment or external instability. If the clear space is lost and the superstructure is causing distress to the wall, it is possible to saw a new gap to relieve the pressure. An alternative method would be to pressure grout and elevate the superstructure back to its original grade, which may also require repair to the approach pavement.

CHAPTER 9. QUALITY CONTROL AND QUALITY ASSURANCE

9.1 INTRODUCTION

Quality is everyone's responsibility. The quality of GRS-IBS begins with an understanding of the concept of wall strength and the interrelation of components of a GRS system and with sound construction practices.

QC consists of implementation, measurement, and enforcement of sound construction practices and field inspection procedures to ensure construction quality as outlined in this manual. QC also involves the selection of quality materials. The successful completion of a project is dependent on a proper monitoring program with necessary adjustments at each stage of construction. QC is the responsibility of the builder.

QA is necessary to ensure the finished product meets specifications through inspection, testing, and final acceptance. The process involves constant evaluation of the project activities related to planning, design, development of plans and specifications, construction, and all interactions associated with these fundamental activities. QA can either be the responsibility of the owner agency or a third-party agency.

9.2 ROLE OF THE CONTRACTOR

Since GRS is a nonproprietary generic wall system, the contractor building the wall can be responsible for developing and maintaining a QA/QC plan for project quality. Prequalification based on the procedures outlined in this manual should be a necessary requirement for this type of construction.

9.3 TESTING

QC testing performed during construction mainly applies to onsite field testing of backfill material and associated laboratory tests.

9.3.1 Laboratory Testing

Gradation and moisture-density tests (e.g., Proctor compaction test) will be required for field monitoring of the backfill material. The classification tests and moisture-density tests should follow AASHTO standards for aggregate sampling and testing.

Large-scale direct shear tests or triaxial tests are the most effective methods for determining the friction angle for coarse-grained backfill aggregates. These methods of testing are preferred over the standard direct shear test (AASHTO T236) or smaller diameter triaxial tests that are performed on the minus No. 10 material.

9.3.2 Field Testing

Fill placement and compaction is the predominant construction activity that needs to be monitored in a GRS-IBS project. Field density tests should be performed on each layer. The field test method should be applicable to the aggregate type that is used for the backfill material.

Dense-graded backfill, which consists of State transportation department crushed base course, can be tested with a nuclear gauge. State transportation department density testing procedures can be used. Moisture content should be monitored and controlled prior to fill placement for an effective compaction process.

A procedural (method-based) specification is preferable for the compaction of open-graded fill material, which exhibits a high percentage of void space. Open-graded gravels are not conducive to in-place nuclear density testing procedures as the direct transmission nuclear gauge procedure is difficult to perform (the transmission hole will typically not stay open), and nuclear backscatter testing is not effective due to poor soil/gauge contact.

In lieu of density testing for open-graded gravels, maximum density can be achieved with a recommended procedural specification. The procedure can specify three to five passes with a walk-behind vibratory plate compactor near the wall face. Larger ride-on vibratory rollers with greater frequency and efficiency can be used in the core of the GRS mass with fewer passes 3 ft from the wall face.

9.4 CONSTRUCTION INSPECTION

Thorough inspection before and during construction will ensure the GRS structure is built in accordance to the plans and guidelines. Inspection requires an understanding of GRS design and methodology. Familiarity and understanding of the drawings is necessary. It is important to have firsthand knowledge of the GRS construction processes. A properly implemented field inspection program provides an opportunity to take corrective action during the construction process.

A critical component of construction is compaction behind the facing element followed by placement of the geosynthetic reinforcement. Those responsible for performing these construction activities are best suited for maintaining the quality of each GRS wall layer. Note that in the RSF and the integrated approach, a geotextile must be used to prevent migration of fill material and erosion.

9.4.1 Materials

Once materials are delivered to the site, they should be inspected for compliance with the guidelines and project specifications. Materials should be visually inspected for quality, damage, and defects.

Backfill: In addition to the quarry material certificate showing the gradation of the aggregate, a visual inspection should be performed to verify maximum grain size, amount of fines and grain shape (angular or rounded), excess fines, moisture content, and durability.

Facing block: As outlined in chapter 3, the facing block should be inspected for integrity, consistency, and dimension tolerances. Confirm that sufficient quantities and proper block type (e.g., solid block, corners, and face block) are present onsite and ready for use.

Geosynthetic reinforcement: Verify that the specified type and strength of geosynthetic is correct along with the required roll dimensions. Chapter 3 provides detailed tests that should be documented for each roll of reinforcement.

9.4.2 Equipment

Compaction of the backfill in a GRS wall or abutment is a critical construction activity. It should be confirmed that the compaction equipment onsite is compatible with the selected backfill material.

Verify that the required hand tools are onsite for spreading and grading aggregate, maintaining the facing alignment, and sweeping the top of the CMU facing block.

9.4.3 Project Layout

Verify that all layout reference points are established, with particular emphasis on the location of the following areas:

- Center line of superstructure.
- RSF area within lines and grade of working drawings.
- Bearing area of the bridge beams.
- Wing wall width and length.
- Clear space and setback.
- Span length.
- Center of bearing to center of bearing.
- Elevations.
- Grades.

9.4.4 Construction Activities

GRS is built from the bottom to the top. Those responsible for inspection need to make certain each layer is constructed and tested in accordance with the contract drawings and specifications before proceeding with subsequent layers. Inspection and QC/QA activities are discussed in this section.

Working bench: Before excavation, the working bench/platform needs to be inspected for stability with consideration for drainage. Any movement should be controlled.

Foundation excavation: The foundation should be cut as outlined in the plan and inspected for any soft areas before compaction and proof rolling.

Geotextile-wrapped RSF foundation: For encapsulation of the RSF, it should be confirmed that the open edge of any overlap is facing downstream and the three sides (two wing walls and one abutment face wall) are contained by a layer of geotextile to prevent erosion.

Leveling course: In order to set the first course of facing block level and plumb, the top elevation of the RSF should be as close to grade as possible. Often, a thin (0.5-inch) leveling layer of aggregate is placed under the first course. Inspection of this leveling layer should be performed to determine its thickness or the need to replace it with a low slump wet concrete/grout mix.

Compaction of backfill: Inspection of backfill operations should verify compliance with the construction guidelines outlined in chapter 7. Compaction behind the wall face and within the bearing area is important. Inspection should confirm that each lift never exceeds the specified thickness.

Compaction control should be maintained through field density tests or other soil stiffness-based methods. For backfill material containing fines (minus No. 200), the moisture content should be within the specified range (± 2 percent). This improves the compaction process. Compaction of open-graded aggregate should be observed to ensure nonmovement of material under the compaction equipment; this observation is an indication of compaction or stiffness and is dictated by the number of passes.

Reinforcement installation: Inspect the installation of each reinforcement layer to ensure it is properly placed, has adequate facing element coverage for the frictional connection, and is free of wrinkles. Anticipate the location and placement of the bearing bed reinforcement layers, particularly in situations when the bridge is superelevated.

Facing block placement: Prior to placement of the reinforcement layer over the facing block, the block should be inspected to verify a clean surface. This is essential in maintaining wall alignment and avoiding block cracking due to point loads. The inspection process should ensure that there is no rocking motion when setting the block, which can be indicative of point load bearing.

Wall alignment: Visual inspection should be performed at regular intervals during construction. This will help ensure that the wall is within vertical and horizontal tolerances for alignment. QC should be performed on block alignment using a string line on at least every third course. Vertical alignment can be checked with a plumb bob.

Wall termination: Make sure that all wing wall terminations are sufficiently embedded to prevent undermining from erosion. A terminated course needs to be founded on a stable compacted layer of granular fill material as outlined in chapter 7 or on an excavated cut into native soils.

Fill slope side: The fill slope at the wing walls is usually built with native soil as the GRS wall advances upward. The fill slope should be constructed with a drain path that leads away from the wall face. Surface runoff should be diverted to prevent saturation of the soil fill slope. Temporary drainage may need to be installed to preserve the integrity of the cut slope.

Site drainage: The working platform should be compacted and graded to drain surface water away from the working area. Any pit excavation should be sloped to drain to a location that can be pumped.

Heavy equipment operation: It is beneficial to have construction equipment centrally located in the work area and to have materials strategically stocked near the equipment for efficient transfer to the labor crew. Equipment operators should take caution when working near large layers of exposed geosynthetic.

Beam seat: Construction of the beam seat should be inspected to confirm the use of methods described in chapter 7. It is important to verify that the beam seat is constructed at the correct elevation and grade to provide the specified clear space and setback.

CMU core grouting: The core of the top three courses of CMU blocks should be filled with concrete wall mix. Rebar dowels should be cut to length (20 inches) and inserted into the core of the top three courses. The concrete mix should be rodded with a rebar dowel before insertion to eliminate voids. Sufficient concrete should be available to form the coping cap during the same pour.

Wrapped integrated approach: Prior to placement of the geotextile reinforcement, it should be verified that the length is adequate to wrap the fill and extend back towards the road as shown in the one-sheet plan. Sufficient reinforcement width should also be available to laterally confine the approach fill if necessary.

The lift thicknesses for each lift should be checked to ensure that they do not exceed the maximum thickness and that secondary reinforcement is placed within fill layers that are greater than 8 inches. If a granular road base is used in the wrapped approach, verify that its compaction conforms to density requirements for the road as well as the GRS.

At the top of the integrated approach, verify that a 1- to 2-inch layer of aggregate is placed on the top reinforcement layer for protection from hot mix asphalt. Verify that the paving fabric, if used, bridges the interface from the deck to the approach as described in chapter 7.

9.5 DOCUMENTATION

9.5.1 Compliance Documentation

Field test results should be carefully measured and archived as a permanent part of the job record. This information can also be used to modify field (construction and inspection) practices.

The main field measurement, moisture density tests, should be documented during construction. Other documentation should include construction modifications, field changes, and daily construction reports.

9.5.2 Record Drawings

As-built plans should be prepared and provided to the owner upon completion of the project.

9.6 CONTRACTING METHODS

Of the two types of contracting methods commonly used for specialty construction, the procedural method and performance method, the preferred approach for the GRS-IBS is the procedural method. GRS performance-based methods can be developed when the technique becomes more widespread.

The generic nature of GRS walls and abutments fits well with the performance-based method, which can advance the technology by creating an opportunity to develop new techniques, details, and equipment.

9.6.1 Performance Method

In a performance-based contract, the contractor can choose a GRS system based on its performance and constructability. The contractor should verify that the GRS-IBS is constructible and performs as outlined in the requirements. Careful attention should be placed on the compatibility between the backfill material, the wall facing, and the reinforcement to assure that the wall meets the necessary requirements.

Under this method, design and performance criteria should be based on the data provided in chapter 4 and chapter 6. Material and construction specifications can be based on the information in chapter 3 and chapter 7. This contract method requires that the reviewers have considerable knowledge in GRS technology to accept design submittals.

9.6.2 Procedural Method

In this contract method, the agency or owner provides a detailed set of design plans and construction specifications in the bid document. QA begins with an initial plan, design, and review of construction materials. Approval should be dependent on someone experienced in the design and construction of the GRS system. Also, the completed project should be in compliance with local agency building codes and regulations.

Fully detailed plans and items requiring review prior to initiating a GRS project should consist of the following:

- Design calculations.
 - Stability analysis.
 - Bearing capacity.
 - Hydraulic analysis.
 - Loads.
- Project drawings (examples of typical GRS-IBS working drawings are presented in appendix D).
 - Plan drawings.
 - Cross sectional drawings of all abutment wall faces and wing walls.
 - Elevation drawings.
 - Horizontal and vertical curve details.
 - Construction details addressing guardrails, parapets, beam seat, wing wall configurations, etc.
 - General notes.

- Fabric schedule.
- Block schedule.
- One-sheet plan for quick reference.
- Geotechnical report.
 - Plan view of testing.
 - Subsurface profile (if necessary).
 - Test boring logs (if necessary) .
 - Laboratory test data.
 - Engineering properties of foundation soil, retained soil, and settlement analysis.
 - Allowable/ultimate bearing pressure of foundation soil.
 - Ground water and free water conditions.
 - Existing abutment conditions (if replacement bridge).
 - Historical flood events.
- Hydrology report.
 - Annual Q50, Q100, and Q200 floodwater levels and velocities.
 - Stable particle size analysis for scour potential.
 - Land uses that could impact flood levels.
- Verification of experience (prequalification): The contractor should be certified or prequalified in GRS construction methods in accordance with the procedures presented in this guide. As an alternative, a contractor should be able to verify demonstrated knowledge in constructing GRS structures. For GRS-IBS projects, the contractor should provide information on the successful construction of many GRS walls and abutments. It is important that the contractor have an understanding of the compatible relationship between wall facings and backfill material.
- QC/QA plan: A QC/QA plan should be developed by the agency or contractor performing the work and should be followed by the contractor. The QC/QA plan should detail types of measurements and documentation that will be maintained during construction to ensure compliance with GRS guidelines and standards.

9.6.3 Contractor Submittals

Materials used to construct GRS-IBS are readily available from a number of sources. The only requirement is that they meet the standards provided in this manual. The main materials that should be reviewed prior to construction are as follows (see chapter 3 for more details):

- CMU block specifications or other type of facing element.
- Backfill gradation, type, and source. The backfill submittal should include aggregates used for the RSF, abutment wall, and integrated approach.
- Geosynthetic reinforcement.

9.7 PROJECT DRAWINGS AND DOCUMENTS

Appendix D provides typical GRS-IBS working drawings that include a one-page plan sheet, estimated quantities and general notes, project plans and profile, GRS abutment details, and a site plan.

APPENDIX A. IN-SERVICE GRADATIONS

At the time of this report, all GRS-IBS projects had selected open-graded gravel due to its relative ease of construction and drainage characteristics. The various counties and agencies that are building GRS-IBS have selected locally available materials for their projects. The gradations and general description are shown in table 11 through table 15.

Table 11. Defiance County, OH, AASHTO No. 89, clean, crushed limestone.

U.S. Sieve Size	Percent Passing
1/2 inch	100
3/8 inch	90–100
No. 4	20–55
No. 8	5–30
No. 16	0–10
No. 50	0–5

Table 12. Warren County, OH, AASHTO No. 67, clean, crushed rock.

U.S. Sieve Size	Percent Passing
1 inch	100
3/4 inch	90–100
3/8 inch	20–55
No. 4	0–10
No. 8	0–5

Table 13. King County, WA, WSDOT 1 1/4-inch minus gravel, clean round rock with sand mixture-pit run.

U.S. Sieve Size	Percent Passing
1 1/4 inch	100
1 inch	90–100
No. 4	50–80
No. 40	0–30
No. 200	0–7

Table 14. St. Lawrence County, NY, NYSDOT No. 1, clean crushed rock.

U.S. Sieve Size	Percent Passing
1 inch	100
1/2 inch	90–100
1/4 inch	0–15
No. 200	0–1

Table 15. Urbana, IL, Seismic Test Abutment, IDOT CA6 road base, subrounded gravel with sand mix.

U.S. Sieve Size	Percent Passing
1 1/2 inch	100
1 inch	90–100
1/2 inch	60–90
No. 4	30–56
No. 16	10–40
No. 200	4–12

APPENDIX B. PERFORMANCE TEST PROCEDURE

B.1 PERFORMANCE TEST OVERVIEW

A performance test (or mini-pier experiment) is recommended to design a GRS abutment if the selected reinforced fill is outside the gradations given in chapter 3. A mini-pier experiment is a large element GRS load test to provide the designer with material strength properties of a particular GRS composite mass built with a unique combination of reinforcement, compacted fill, and facing elements. The procedure involves axially loading the GRS mass while measuring vertical settlement and lateral deformation to monitor performance. This information can then be used to aid in the design process to predict performance of a full-scale GRS composite mass.

The performance test concept has been applied to smaller-scale models from small triaxial-sized samples to 2-ft cubed specimens in small-capacity test frames.^(24,25) However, due to the size of the aggregates that are often used in GRS fills, larger-scale models must be used to adequately predict the performance of a full-scale GRS abutment. Several large-scale tests have also been conducted.^(11,25,26) The proposed performance test, outlined in this appendix, has been shown to accurately predict the actual settlement of in-service GRS abutments (see chapter 4).^(12,27,28)

The reinforcement, fill (compaction effort), and facing materials in the performance test should be the same as what is planned for the GRS abutment. The spacing of the reinforcement is dictated by the abutment design, which is recommended to be 8 inches at most. The bearing reinforcement bed should extend through the top two courses of blocks. Since the specifics of the performance test will be dictated by the actual abutment design and materials, set dimensions and materials will vary between each mini-pier experiment. The base-to-height ratio should be 2:1 (with the base width measured inside the facing elements). It is advisable to have a contact area that is slightly less than the footprint of the GRS mass, inset 2–3 inches on all sides. Two examples are provided to guide the designer or user on how to construct and test a model.

B.2 PERFORMANCE TEST EXAMPLE: VEGAS MINI-PIER

The following example is an actual performance test that was conducted, called the Vegas Mini-Pier Experiment. The reinforcement strength and spacing and the fill and facing elements are different from those outlined in the design of a GRS abutment presented in chapter 4. This example shows how a performance test can facilitate design with a unique combination of reinforcement, soil, and facing elements.

In this test, the abutment was to be constructed with a reinforcement spacing of 6 inches and a bearing reinforcement bed of 3-inch spacing extended into the top two courses of blocks. The reinforcement was a woven PP geotextile with a wide width tensile strength of 2,400 lb/ft, per ASTM D4595.

The gravel was classified as a GP-GM soil according to ASTM D2488 with a maximum diameter of 1 inch. The cohesion and friction angle of this material were 580 lb/ft² and 40 degrees. Compaction of the fill for the mini-pier was performed with a hand tamper at the optimum moisture content. Considerable effort to compact each lift of soil was made, but soil density measurements were not

taken during the construction process. Note that compaction testing (or a method specification for open-graded gravels) should be performed for each lift in a standard performance test.

The facing elements were segmental retaining wall (SRW) blocks. The modular block was solid dry-cast concrete and had a split face. The height of the block was 6 inches and equal to the spacing of the reinforcement. The unit weight of each block was 82 lb. The blocks were frictionally connected to the GRS mass without the aid of pins or mechanical connection. To form the corners, the block was split, as shown in figure 86. The layout of the SRW blocks and the reinforcement schedule are shown in figure 86 and figure 87.

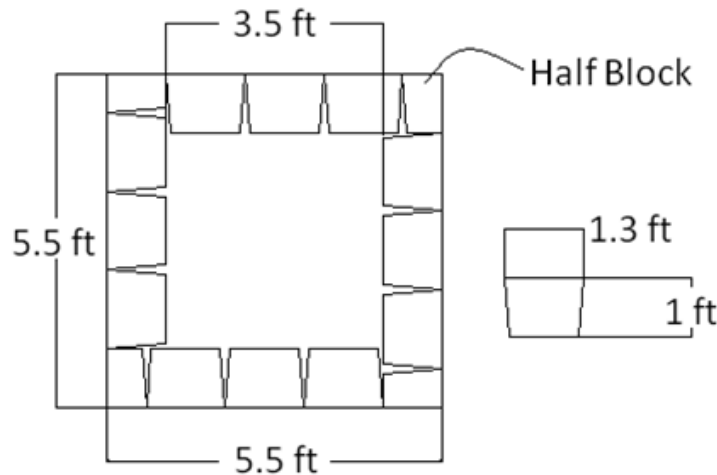

Figure 86. Illustration. Plan view of Vegas Mini-Pier Experiment.

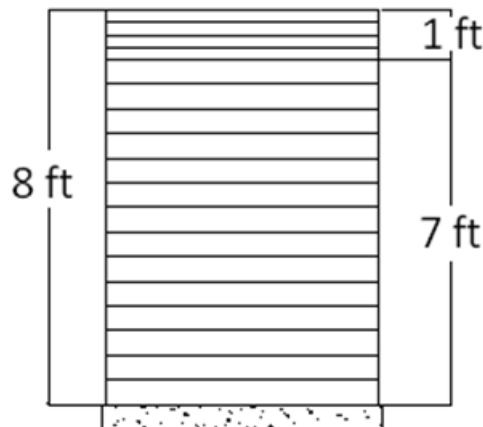

Figure 87. Illustration. Elevation view of Vegas Mini-Pier Experiment.

The scaled GRS mass was built on a concrete base pad (see figure 88). The base pad was elevated on the cinderblock to make room for the two bolted channel beams. The load test setup is illustrated in figure 89 and figure 90. The top set of bolted channels was supported on the top concrete pad, which was centered on the GRS mass. The top pad was not supported on the SRW blocks (see figure 89). The upper and lower channel beams were coupled together with threaded bar. Four hollow-core hydraulic jacks were bolted to the top channel beams (see figure 91). All jacks were connected to a manifold and controlled with a servo-controlled hydraulic pump.



Figure 88. Photo. Vegas Mini-Pier Experiment reaction base.

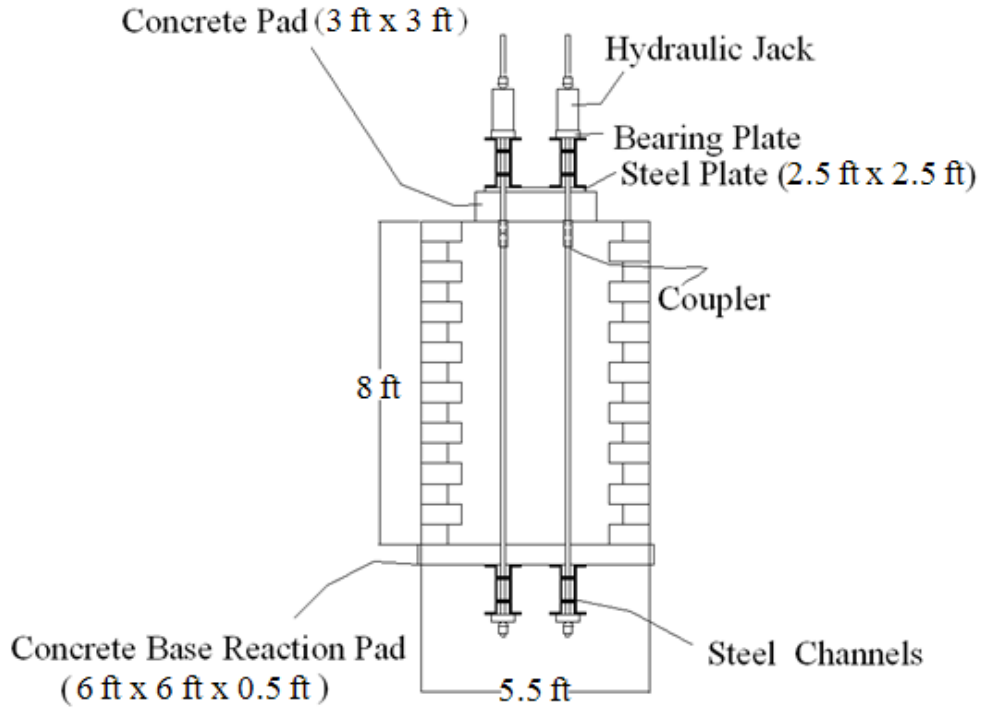

Figure 89. Illustration. Side view of Vegas Mini-Pier Experiment.

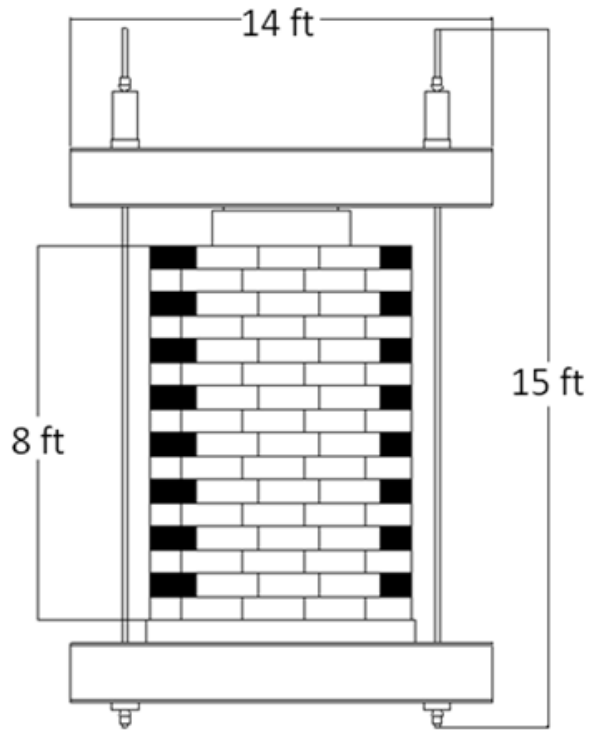

Figure 90. Illustration. Face view of Vegas Mini-Pier Experiment.



Figure 91. Photo. Hollow-core hydraulic ram bolted to the top channel beams.

During the load test, vertical stress was applied in increments of 5 psi. Load was measured with a hydraulic oil pressure gauge and a load cell. Vertical stress was calculated by dividing the sum of the force from each jack by the area of the GRS mass. The top area of the GRS mass was 3.5 ft by 3.5 ft. The area of the top pad was 3 ft by 3 ft, less than the area of the GRS mass (see figure 89).

Each load increment was maintained between 5 to 7 min. Vertical and lateral deformations of the GRS mass were recorded during each load increment. Deformations were measured with dial gauges referenced off scaffolding next to the mini-pier. Vertical settlements were measured on the four corners of the top pad while lateral deformations were measured at five points along one wall face of the GRS mass. Ceramic tiles were glued to the concrete pad and SRW block to create a smooth surface for accurate measurement of deformation.

The experiment was terminated at a vertical stress of 145 psi. The vertical strain at this stress was measured at 2.9 percent. At this point, the stroke on the dial gauges and linear variable differential transformers ran out, so the test was ended. The resulting stress-strain curve is shown in figure 92.

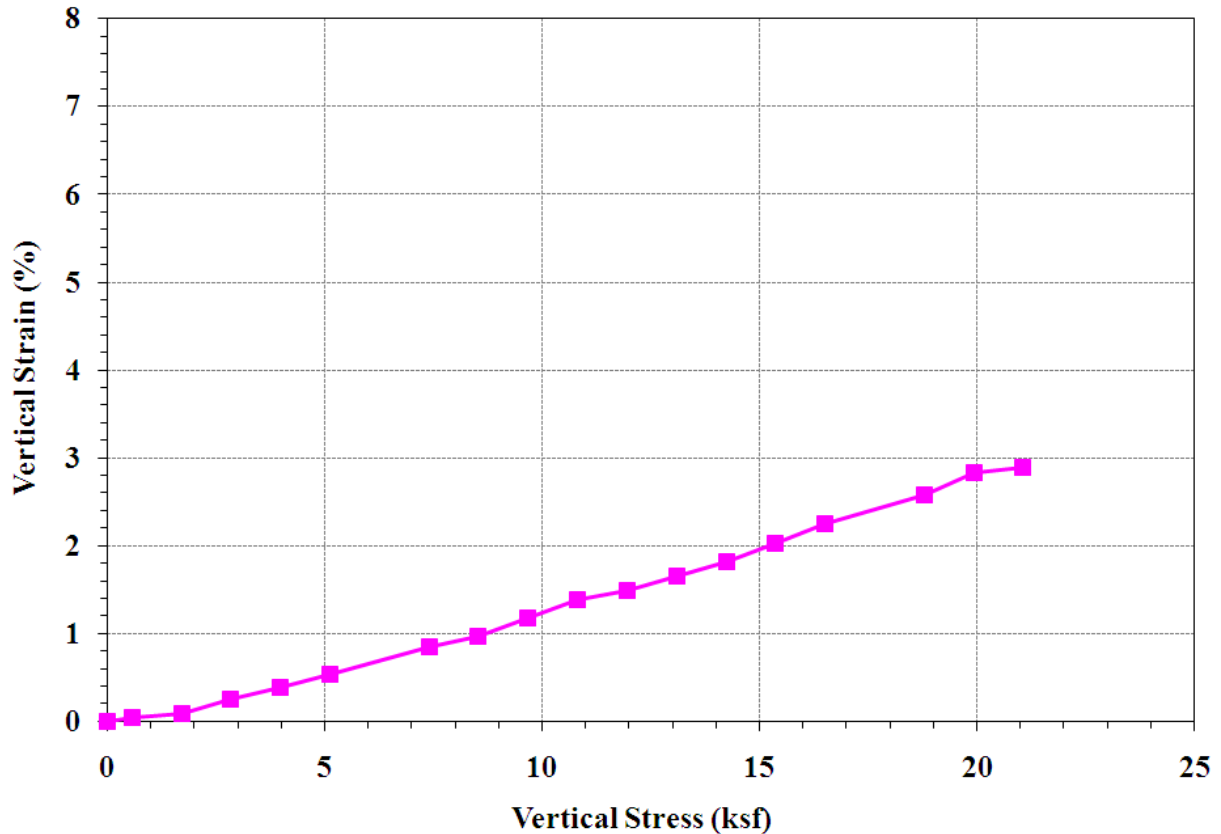

Figure 92. Graph. Vegas Mini-Pier stress-strain curve.

B.3 PERFORMANCE TEST EXAMPLE: DEFIANCE COUNTY PERFORMANCE TEST

The following example is an actual performance test that was conducted, called the Defiance County Performance Test. The reinforcement strength and spacing and the fill and facing elements were the same as those outlined in the design of a GRS abutment in chapter 4. The layout of the CMU blocks and the reinforcement schedule are shown in figure 93 and figure 94.

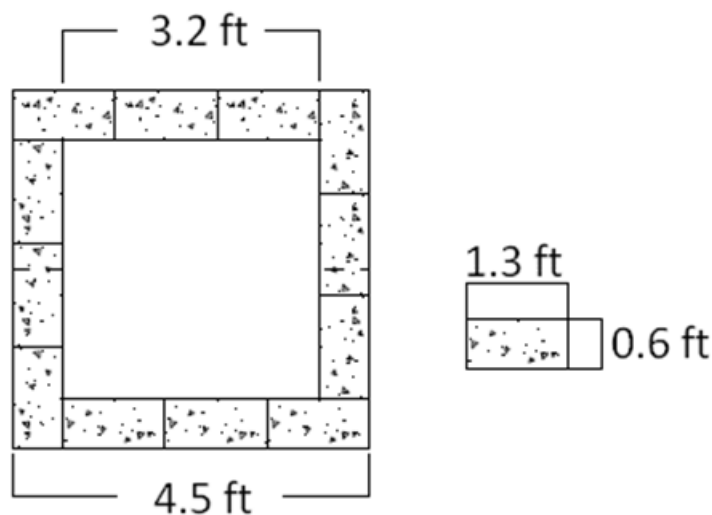

Figure 93. Illustration. Plan view of Defiance County experiment.

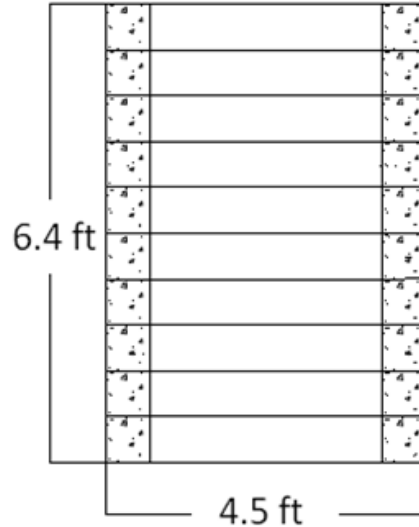

Figure 94. Illustration. Elevation view of Defiance County experiment.

In this test, the abutment was constructed with a reinforcement spacing of 8 inches and a bearing reinforcement bed of 4-inch spacing extended in the top two courses of block. The reinforcement was a woven PP geotextile, with a wide width tensile strength of 4,800 lb/ft, per ASTM D4595.

The gravel was classified as AASHTO No. 89 stone, according to ASTM D2488, with a maximum diameter of 0.5 inches. There was zero cohesion and a 48 degree friction angle (as determined using a large shear box test). Compaction of the fill was performed with a hand tamper. Considerable effort to compact each lift of fill was made, but soil density measurements were not taken during the construction process.

The facing elements were CMU blocks. The modular block was solid dry-cast concrete and had a split face. The height of the block was 8 inches and was equal to the spacing of the reinforcement. The unit weight of each block was 42 lb. The blocks were connected to the GRS without the aid of pins or mechanical connection. The layout of the CMU blocks and the reinforcement schedule are shown in figure 93 and figure 94.

The scaled GRS mass was built on a concrete base pad similar to that of the Vegas Mini-Pier Experiment (see figure 95). The red lines on the concrete base and top reaction pads in figure 95 show the principle direction of the rebar reinforcement to transfer the force from the channels to the pads. The base pad was elevated with cinderblocks to make room for the two bottom reaction channel beams. The top set of bolted channels was supported on the top concrete pad, which was centered on the GRS mass. The top pad was set inside the perimeter of the CMU block by 2.5 inches. The upper and lower channel beams were coupled together with threaded bar, bearing plates, and nuts.



Figure 95. Photo. Defiance County experiment before testing.

Load increments were applied to capture both the linear elastic and plastic portions of the stress-strain behavior of the composite mass (see figure 96). Load was measured with a hydraulic oil pressure gauge and load cell. Vertical stress was calculated by dividing the sum of the force from each jack by the area of the GRS mass. The top area of the GRS mass was 3.2 ft by 3.2 ft. The area of the top pad was 2.75 ft by 2.75 ft to create a uniform load distribution.

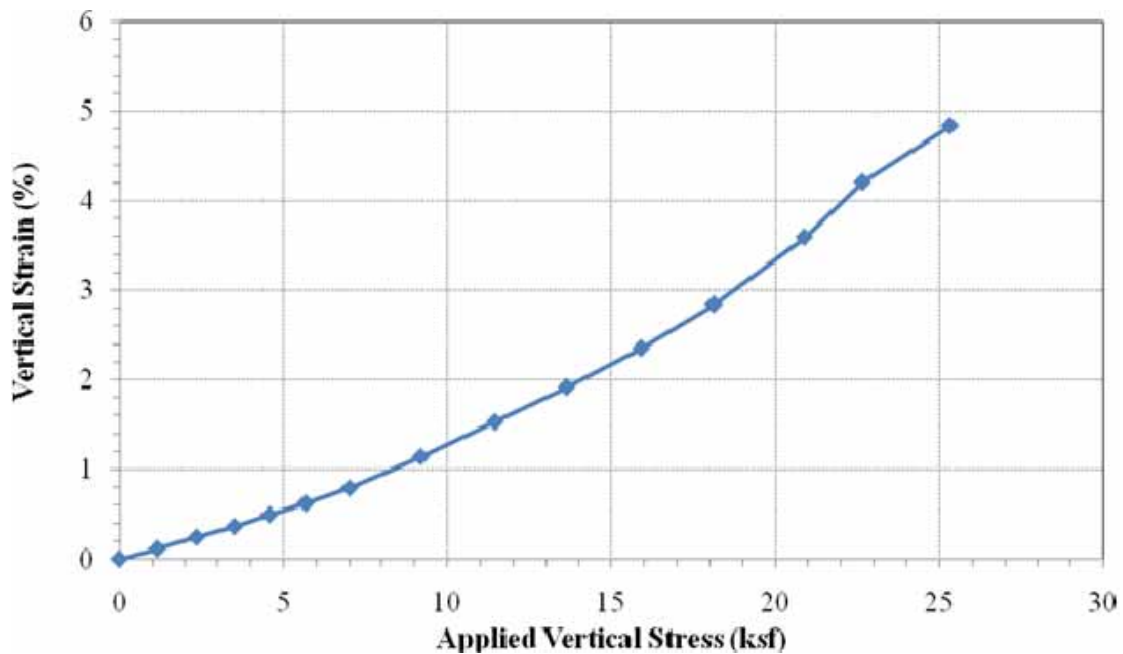

Figure 96. Graph. Defiance County stress-strain curve.

Vertical and lateral deformations of the GRS mass were recorded during each load increment. Deformations were measured with dial gauges referenced off scaffolding next to the mini-pier (see figure 95). Vertical settlements were measured on the four corners of the top pad while lateral deformations were measured at five points along one wall face of the GRS mass. Ceramic tiles were glued to the concrete pad and CMU block to create a smooth surface for accurate measurement of deformation.

The experiment was terminated at a vertical stress of 180 psi. The vertical strain at this stress was measured at 4.8 percent. After this extreme loading, the mini-pier remained standing with a symmetrical bulge in the upper third of the wall (see figure 97). Note the slightly displaced blocks in this area. The resulting stress-strain curve is shown in figure 96.



Figure 97. Photo. Defiance County experiment after testing.

The Defiance County experiment was also conducted with a weaker fabric (2,400 lb/ft), using the same fill material and reinforcement spacing. The resulting stress-strain curve is shown in figure 98. Note that the strain upon completion of the test was 4.6 percent, about the same as the performance test with stronger fabric (4,800 lb/ft). The ultimate applied stress, however, is much different as a result of the decreased strength of the reinforcement that was used (see figure 99). At a working stress of 4 ksf, the strain using the weaker fabric is about 1.0 percent (see figure 98), well above the tolerable limit of 0.5 percent. Using the results of these tests, the stronger fabric (4,800 lb/ft) was chosen for the GRS-IBS application in Defiance County, OH.

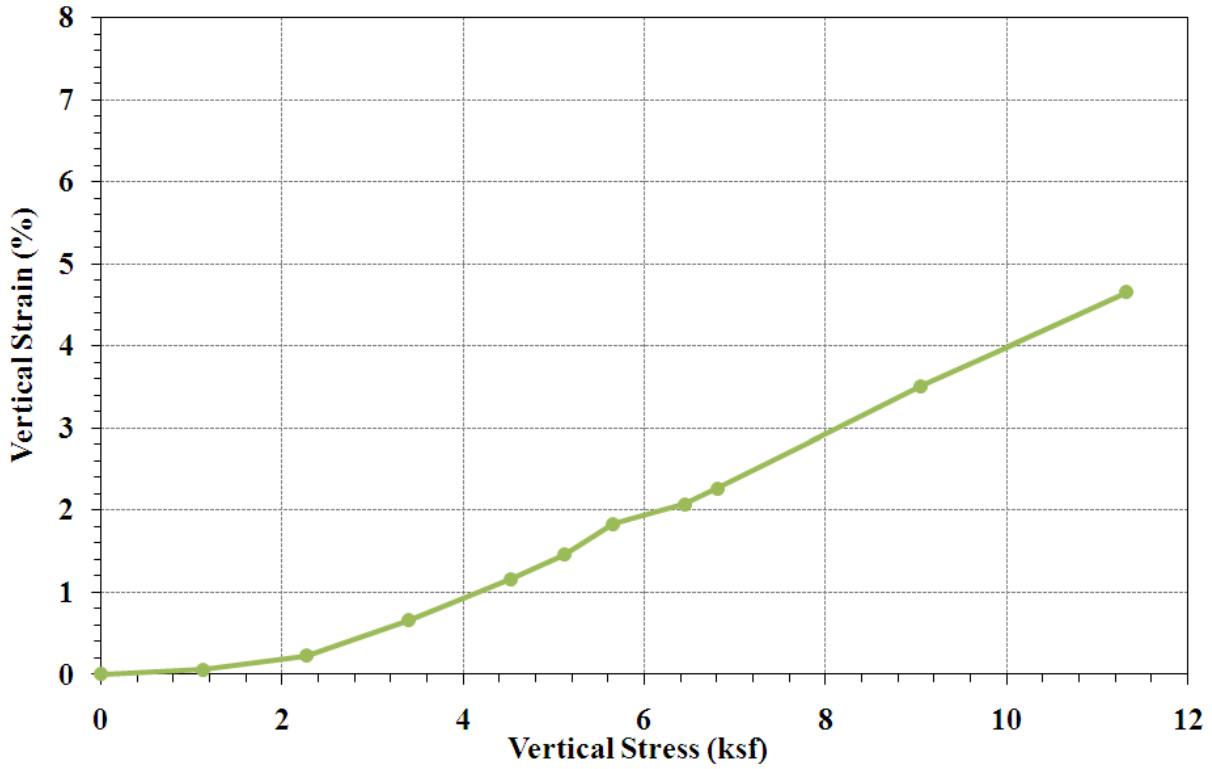

Figure 98. Graph. Defiance County stress-strain curve (weaker fabric).

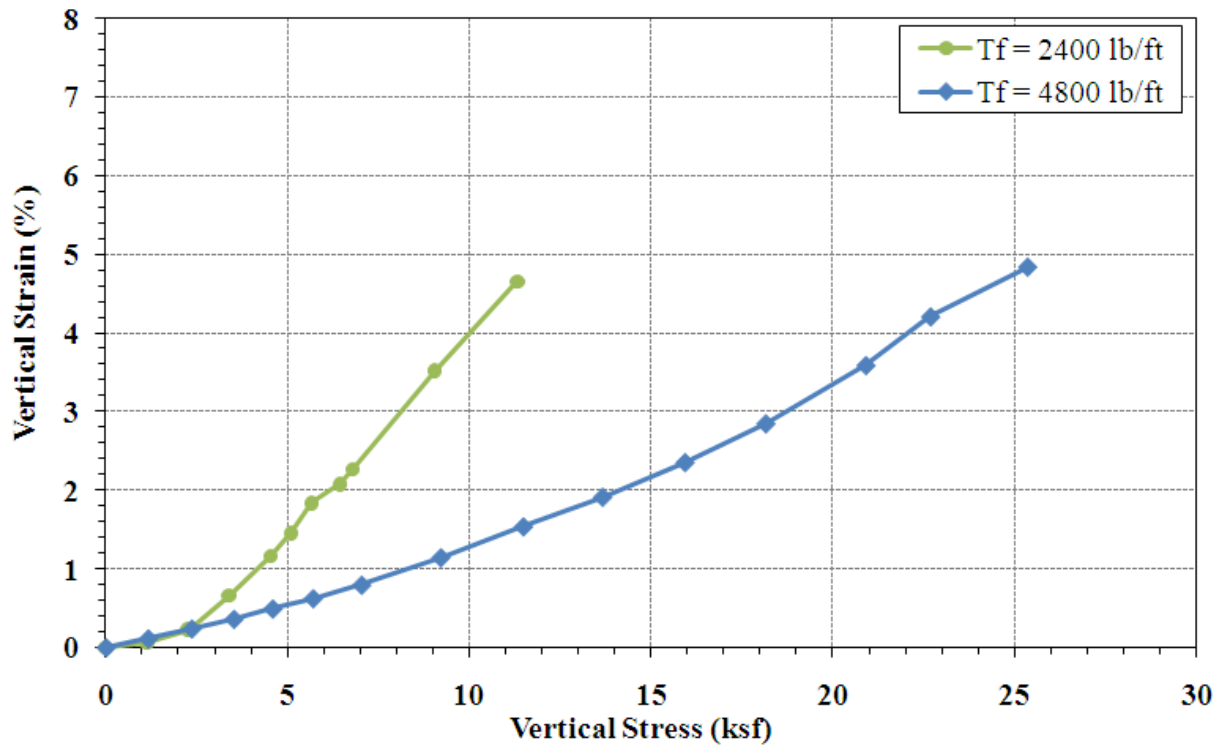

Figure 99. Graph. Defiance County experiment comparison.

APPENDIX C. LRFD DESIGN PROCEDURE

C.1 INTRODUCTION

An AASHTO LRFD procedure is presented in this appendix to permit the designer a choice of design methodology formats for GRS-IBS.⁽⁹⁾ This procedure is primarily a fit to the ASD solution but does include some LRFD features. For example, checking the external stability of earth-retaining structures is well defined by AASHTO LRFD. For internal stability of GRS structures, however, LRFD is not well defined yet. Since there is not enough statistical information available to fully calibrate LRFD for internal stability, the LRFD method has been fit to ASD. This means that the designer will arrive at the same answer for internal stability whether using ASD or LRFD. In the future, once more performance tests and case studies have been evaluated, the resistance factors for both vertical capacity and reinforcement strength may change from those presented in this appendix.

For LRFD, AASHTO defines the various load factors and load combinations that need to be considered in the design of bridge and transportation structures.⁽⁹⁾ Table 16 and table 17 reproduce these load combinations and load factors. Resistance factors for external stability are also given by AASHTO.⁽⁹⁾ For direct sliding, a resistance factor for shear resistance (ϕ_r) is included. For sliding of soil on soil, ϕ_r is equal to 1. For bearing capacity, the resistance factor (ϕ_{bc}) is equal to 0.65. Finally, for global stability, the resistance factor is 0.65.

Table 16. Typical load combinations and load factors.⁽⁹⁾

Load Combination Limit State	DC DD DW EH EV ES EL PS CR SH	LL IM CE BR PL LS	WA	WS	WL	FR	TU	TG	SE	Use one of these at a time			
										EQ	IC	CT	CV
Strength I (unless noted)	γ_p	1.75	1.00	—	—	1.00	0.50/1.20	γ_{TG}	γ_{SE}	—	—	—	—
Strength II	γ_p	1.35	1.00	—	—	1.00	0.50/1.20	γ_{TG}	γ_{SE}	—	—	—	—
Strength III	γ_p	—	1.00	1.40	—	1.00	0.50/1.20	γ_{TG}	γ_{SE}	—	—	—	—
Strength IV	γ_p	—	1.00	—	—	1.00	0.50/1.20	—	—	—	—	—	—
Strength V	γ_p	1.35	1.00	0.40	1.00	1.00	0.50/1.20	γ_{TG}	γ_{SE}	—	—	—	—
Extreme Event I	γ_p	γ_{EQ}	1.00	—	—	1.00	—	—	—	1.00	—	—	—
Extreme Event II	γ_p	0.50	1.00	—	—	1.00	—	—	—	—	1.00	1.00	1.00
Service I	1.00	1.00	1.00	0.30	1.0	1.00	0.50/1.20	γ_{TG}	γ_{SE}	—	—	—	—
Service II	1.00	1.30	1.00	—	—	1.00	0.50/1.20	—	—	—	—	—	—
Service III	1.00	0.80	1.00	—	—	1.00	0.50/1.20	γ_{TG}	γ_{SE}	—	—	—	—
Service IV	1.00	—	1.00	0.70	—	1.00	0.50/1.20	—	1.0	—	—	—	—
Fatigue I—LL, IM and CE only	—	1.50	—	—	—	—	—	—	—	—	—	—	—
Fatigue I II—LL, IM and CE only	—	0.75	—	—	—	—	—	—	—	—	—	—	—

Table 17. Load factors for permanent loads.⁽⁹⁾

Type of Load, Foundation Type, and Method Used to Calculate Downdrag		Load Factor	
		Maximum	Minimum
<i>DC</i> : Component and Attachments		1.25	0.90
<i>DC</i> : Strength IV only		1.50	0.90
<i>DD</i> : Downdrag	Piles, α Tomlinson Method	1.40	0.25
	Piles, λ Method	1.05	0.30
	Drilled shafts, O’Neill and Reese (1999) Method	1.25	0.35
<i>DW</i> : Wearing Surfaces and Utilities		1.50	0.65
<i>EH</i> : Horizontal Earth Pressure			
<ul style="list-style-type: none"> • Active 		1.50	0.90
<ul style="list-style-type: none"> • At-Rest 		1.35	0.90
<ul style="list-style-type: none"> • AEP for anchored walls 		1.35	N/A
<i>EL</i> : Locked-in Construction Stresses		1.00	1.00
<i>EV</i> : Vertical Earth Pressure			
<ul style="list-style-type: none"> • Overall Stability 		1.00	N/A
<ul style="list-style-type: none"> • Retaining Wall and Abutments 		1.35	1.00
<ul style="list-style-type: none"> • Rigid Buried Structure 		1.30	0.90
<ul style="list-style-type: none"> • Rigid Frames 		1.35	0.90
<ul style="list-style-type: none"> • Flexible Buried Structures other than Metal Box Culverts 		1.95	0.90
<ul style="list-style-type: none"> • Flexible Metal Box Culverts and Structural Plate Culverts with Deep Corrugations 		1.50	0.90
<i>ES</i> : Earth Surcharge		1.50	0.75

C.2 GRS-IBS DESIGN GUIDELINES

The following nine basic steps for the design of GRS-IBS are reproduced from section 4.4:

1. Establish project requirements.
2. Perform a site evaluation.
3. Evaluate project feasibility.
4. Determine layout of GRS-IBS.
5. Calculate loads.
6. Conduct external stability analysis.
7. Conduct internal stability analysis.
8. Implement design details.
9. Finalize GRS-IBS.

Once these steps are accomplished, the GRS-IBS can be constructed. The basic design guidelines are the same whether using ASD or LRFD. However, the detailed equations within step 6 and step 7 will differ between the two design methods. In this appendix, only the differences in step 6 and step 7 that result from conversion to the LRFD format are presented. Refer to section 4.4 for discussion on each of these design elements and the equivalent ASD equations and to section 4.5 for the ASD calculation.

C.2.1 Step 6—Conduct an External Stability Analysis

The external stability of a GRS-IBS is evaluated by looking at the following potential external failure mechanisms:

- Direct sliding.
- Bearing capacity.
- Global stability.

C.2.1.1 Direct Sliding

The total factored driving force for LRFD (F_R) is calculated in much the same way as in ASD (F_n) except load factors are applied to each component of thrust force. Equation 70 modifies equation 13 to include the load factors $\gamma_{EH\ MAX}$, $\gamma_{ES\ MAX}$, and γ_{LS} , which are determined using table 16 and table 17.

$$F_R = \gamma_{EH\ MAX} F_b + \gamma_{ES\ MAX} F_{rb} + \gamma_{LS} F_t \quad (70)$$

The factored resisting force (R_R) is calculated using equation 71. This equation is the LRFD modification of equation 14 that includes a shear resistance factor (Φ_τ). For sliding, Φ_τ is equal to 1.0.⁽⁹⁾

$$R_R = \Phi_\tau (W_{t,R} \mu) \quad (71)$$

Where $W_{t,R}$ is determined using equation 72, which is equation 15 modified to include the appropriate load factors, $\gamma_{EV\ MIN}$, $\gamma_{DC\ MIN}$ and $\gamma_{DC\ MIN}$, from table 17.

$$W_{t,R} = \gamma_{EV\ MIN} W + \gamma_{DC\ MIN} (q_b b) + \gamma_{ES\ MIN} (q_{rb} b_{rb,t}) \quad (72)$$

For LRFD, the ratio of the factored resistance and the factored driving force must be greater than or equal to 1.0 (see equation 73). If not, consider lengthening the reinforcement at the base.

$$\frac{R_R}{F_R} \geq 1.0 \quad (73)$$

C.2.1.2 Bearing Capacity

In this section, the ASD equations to evaluate bearing capacity have been modified to include the appropriate load and resistance factors of LRFD. Equation 74 is the LRFD version of equation 18.

$$\sigma_{v,base,R} = \frac{\Sigma V_R}{B_{RSF} - 2e_{B,R}} \quad (74)$$

Where ΣV_R is the total factored vertical load on the GRS abutment (see equation 75), B_{RSF} is the width of the RSF, and $e_{B,R}$ is the eccentricity of the resulting force at the base of the wall (see equation 76).

$$\begin{aligned} \Sigma V_R = & \gamma_{EV\ MAX}(W) + \gamma_{EV\ MAX}(W_{RSF}) + \gamma_{DC\ MAX}(W_{face}) + \gamma_{LS}(q_t b_{rb,t}) \\ & + \gamma_{ES\ MAX}(q_{rb} b_{rb,t}) + \gamma_{DC\ MAX}(q_b b) + \gamma_{LS}(q_{LL} b) \end{aligned} \quad (75)$$

$$e_{B,R} = \frac{\Sigma M_{D,R} - \Sigma M_{R,R}}{\Sigma V_R} \quad (76)$$

Where $\gamma_{EV\ MAX}$, γ_{LS} , $\gamma_{ES\ MAX}$ and $\gamma_{DC\ MAX}$, are load factors found from table 16 and table 17, W is the weight of the GRS abutment, W_{RSF} is the weight of the RSF, W_{face} is the weight of the facing elements, q_t is the roadway LL, q_{rb} is the road base DL, $b_{rb,t}$ is the width of the traffic and road base surcharges over the GRS abutment, q_b is the bridge DL, b is the width of the bridge seat, q_{LL} is the bridge LL, $\Sigma M_{D,R}$ is the total factored driving moment, $\Sigma M_{R,R}$ is the total factored resisting moment, and ΣV_R is the total factored vertical load. The moments should be calculated about the bottom center of the RSF length for the specific layout of the GRS abutment. If $e_{B,R}$ is negative, take $e_{B,R}$ equal to zero for the term $B_{RSF} - 2e_{B,R}$.

The factored bearing capacity of the foundation (q_R) can be found using equation 77. Based on AASHTO, the resistance factor (ϕ_{bc}) is equal to 0.65.⁽⁹⁾

$$q_R = \Phi_{bc} \left(c_f N_c + \frac{1}{2} B' \gamma_f N_\gamma + \gamma_f D_f N_q \right) \quad (77)$$

Where c_f is the cohesion of the foundation soil, N_c , N_γ , and N_q are dimensionless bearing capacity coefficients (see table 4), γ_f is the unit weight of the foundation soil, B' is the effective foundation width (equal to $B_{RSF} - 2e_{B,R}$), and D_f is the depth of the embedment.

The ratio of the factored bearing resistance and the factored applied pressure must be greater than or equal to 1.0 (see equation 78). If not, increase the width of the GRS abutment and RSF (by increasing the length of the reinforcement layers), replace the foundation soil with a more competent soil, or add embedment depth.

$$\frac{q_R}{\sigma_{v,base,R}} \geq 1.0 \quad (78)$$

C.2.1.3 Global Stability

According to AASHTO, the Service I Load Combination should be used to evaluate global stability.⁽⁹⁾ For the Service I limit state, the load factor is 1.0 for permanent loads. When the geotechnical parameters are not well defined or the slope does contain or support a structural element, the shear resistance factor is 0.65. This corresponds to a factor of safety of 1.5.

C.2.2 Step 7—Conduct Internal Stability Analysis

C.2.2.1 Vertical Capacity

It is recommended that the ultimate capacity be found empirically, if possible. A resistance factor for capacity (Φ_{cap}) of 0.45 should be applied to the nominal vertical capacity (q_n) to account for uncertainty. This resistance factor value is based on fitting to the ASD method.

C.2.2.1.1 Empirical Method: The factored applied pressure on the GRS abutment ($V_{applied,f,emp}$) is equal to the sum of the vertical pressures on the bridge bearing area multiplied by their respective load factors (see equation 79). The vertical pressures include the bridge DL (q_b) and LL (q_{LL}).

$$V_{applied,f} = \gamma_{DC\ MAX} q_b + \gamma_{LL} q_{LL} \quad (79)$$

Where $\gamma_{DC\ MAX}$ and γ_{LL} are load factors found from table 16 and table 17. The factored applied pressure must be less than or equal to the factored vertical capacity (see equation 80). The resistance factor (Φ_{cap}) is equal to 0.45.

$$\frac{\Phi_{cap}(q_{n,emp})}{V_{applied,f}} \geq 1.0 \quad (80)$$

C.2.2.1.2 Analytical Method: As an alternative, the load-carrying capacity of a GRS abutment can be evaluated using an analytical formula, referred to as the soil-geosynthetic composite capacity equation.⁽¹¹⁾

The nominal ultimate load-carrying capacity ($q_{n,an}$) of a GRS wall constructed with a granular backfill can be determined by the soil-geosynthetic composite capacity equation, shown in equation 81.⁽¹¹⁾

$$q_{n,an} = \left[0.7 \left(\frac{S_v}{6d_{max}} \right) \frac{T_f}{S_v} \right] K_{pr} \quad (81)$$

Where S_v is the reinforcement spacing, d_{max} is the maximum grain size of the reinforced backfill, T_f is the ultimate strength of the reinforcement, and K_{pr} is the coefficient of passive earth pressure determined using equation 26.

The factored applied pressure on the GRS mass ($V_{applied,f}$) is equal to the sum of the vertical forces multiplied by their respective load factors (see equation 82). This includes the bridge DL (q_b) and LL (q_{LL}). The DL due to the road base (q_{rb}) and the LL due to the approach pavement (q_t) are located behind the bearing area and are therefore not included in capacity calculations related to the bridge superstructure.

$$V_{applied,f} = \gamma_{DC\ MAX} q_b + \gamma_{LL} q_{LL} \quad (82)$$

Where $\gamma_{DC\ MAX}$ and γ_{LL} are load factors found from table 16 and table 17. The factored applied pressure must be less than the factored ultimate capacity (see equation 83). The resistance factor (Φ_{cap}) is equal to 0.45.

$$\frac{\Phi_{cap}(q_{n,an})}{V_{applied,f}} \geq 1.0 \quad (83)$$

C.2.2.2 Deformations

The method to estimate both vertical and lateral deformations is not dependent on the design code chosen (ASD or LRFD). Therefore, refer to section 4.4.7.2 to estimate deformations.

C.2.2.3 Required Reinforcement Strength

The factored required reinforcement strength in the direction perpendicular to the wall face ($T_{req,f}$) can be determined analytically by equation 84. The required factored reinforcement strength should be calculated at each layer of reinforcement to ensure adequate strength throughout the GRS abutment. For the serviceability check (comparing the required strength to the reinforcement strength at 2 percent strain), the unfactored required reinforcement strength should be used (see equation 85).

$$T_{req,f} = \left[\frac{\sigma_{h,f}}{0.7 \left(\frac{S_v}{6d_{max}} \right)} \right] S_v \quad (84)$$

$$T_{req} = \left[\frac{\sigma_h}{0.7 \left(\frac{S_v}{6d_{max}} \right)} \right] S_v \quad (85)$$

Where S_v is the reinforcement spacing, d_{max} is the maximum grain size of backfill, $\sigma_{h,f}$ is the total factored lateral stress within the GRS abutment at a given depth and location (see equation 86), and σ_h is the total unfactored lateral stress within the GRS abutment at a given depth and location (equation 32).

$$\sigma_{h,f} = \sigma_{h,W,f} + \sigma_{h,bridge,f} + \sigma_{h,rb,f} + \sigma_{h,t,f} \quad (86)$$

Where $\sigma_{h,W,f}$ is the factored lateral earth pressure using Rankine's active stress condition (see equation 87), $\sigma_{h,bridge,f}$ is the factored lateral pressure due to the equivalent bridge load (see equation 88), $\sigma_{h,rb,f}$ is the factored lateral pressure due to the road base DL (see equation 89), and $\sigma_{h,t,f}$ is the factored lateral pressure due to the roadway LL (see equation 90).

$$\sigma_{h,W,f} = \gamma_{EH\ MAX} (\gamma_r z K_{ar}) \quad (87)$$

$$\sigma_{h,bridge,f} = \frac{(\gamma_{DC\ MAX} q_b + \gamma_{LL} q_{LL}) - (\gamma_{ES\ MAX} q_{rb} + \gamma_{LS} q_t)}{\pi} [\alpha_b + \sin(\alpha_b) \cos(\alpha_b + 2\beta_b)] K_{ar} \quad (88)$$

$$\sigma_{h,rb,f} = \gamma_{ES\ MAX} q_{rb} K_{ar} \quad (89)$$

$$\sigma_{h,t,f} = \gamma_{LS} q_t K_{ar} \quad (90)$$

Where $\gamma_{DC\ MAX}$, $\gamma_{ES\ MAX}$, γ_{LS} , and γ_{LL} are load factors found from table 16 and table 17; q_b , q_{rb} , q_t , and q_{LL} are the bridge DL, road base DL, roadway LL and bridge LL, respectively; K_{ar} is the active earth pressure coefficient for the reinforced fill; and α_b and β_b are the angles shown in figure 15, found using equation 91 and equation 92, respectively.

$$\alpha_b = \tan^{-1} \left(\frac{b}{2Z} \right) - \beta_b \quad (91)$$

$$\beta_b = \tan^{-1} \left(\frac{-b}{2Z} \right) \quad (92)$$

For abutments, a minimum wide width tensile strength (T_f) of 4,800 lb/ft is required. A resistance factor for reinforcement strength (Φ_{reinf}) of 0.4 should be applied to the ultimate strength (T_f) to determine the factored reinforcement strength ($T_{f,f}$). The factored required reinforcement strength ($T_{req,f}$) must be less than this factored reinforcement strength ($T_{f,f}$), as shown in equation 93.

$$\frac{T_{f,f}}{T_{req,f}} = \frac{\Phi_{reinf} (T_f)}{T_{req,f}} = \frac{0.4(T_f)}{T_{req,f}} \geq 1.0 \quad (93)$$

Since geosynthetic reinforcements of similar strength can have rather different load-deformation relationships depending on their material, it is important that the nominal (unfactored) T_{req} be less than the strength at 2 percent reinforcement strain. The strength of the reinforcement at 2 percent ($T_{@ \varepsilon=2\%}$) is often given by the geosynthetic manufacturer. If the unfactored T_{req} is greater than $T_{@ \varepsilon=2\%}$, either a different geosynthetic must be chosen or the ultimate strength must be increased.

C.3 DESIGN EXAMPLE (LRFD): BOWMAN ROAD BRIDGE, DEFIANCE COUNTY, OH

In this section, the equations formatted for the LRFD method in section C.2 are demonstrated. For additional details and discussion in support of these calculations, see the corresponding sections of the design example in the ASD format contained in section 4.5.

C.3.6 Step 6—Conduct an External Stability Analysis

C.3.6.1 Direct Sliding

The driving forces on the GRS abutment are comprised of the lateral forces due to the retained backfill, the road base and the traffic surcharge. The force due to the backfill is calculated in equation 94.

$$F_b = \frac{1}{2} \gamma_b K_{ab} H^2 = \frac{1}{2} (120)(0.361)(15.58)^2 = 5258 \text{ lb/ft} \quad (94)$$

The lateral force due to the road base and traffic surcharges are calculated in equation 95 and equation 96.

$$F_{rb} = q_{rb} K_{ab} H = 385(0.361)(15.58) = 2165 \text{ lb/ft} \quad (95)$$

$$F_t = q_t K_{ab} H = 298(0.361)(15.58) = 1676 \text{ lb/ft} \quad (96)$$

The total factored driving force (F_R) is then calculated in equation 97. The load factors are determined using table 16 and table 17.

$$F_R = \gamma_{EH\ MAX} F_b + \gamma_{ES\ MAX} F_{rb} + \gamma_{LS} F_t = 1.5(5258) + 1.5(2165) + 1.75(1676) \\ = 14068\ \text{lb/ft} \quad (97)$$

The factored resisting force (R_R) is calculated according to equation 71, where ϕ_T is the resistance factor for shear resistance (equal to 1.0 for sliding).⁽⁹⁾ The total resisting weight ($W_{t,R}$) includes the weight of GRS plus the weight of bridge beam plus the weight of the road base over the GRS abutment, as shown in equation 72. Since the LLs are not permanent, they cannot be counted as a resisting force. The total resisting weight is calculated in equation 98.

$$W_{t,R} = 1(9257) + 0.9[2600(4)] + 0.75[385(0.7)] = 18819\ \text{lb/ft} \quad (98)$$

The friction force (μ) is equal to $\tan\phi_{crit}$. The interface friction angle between the reinforced fill and the geotextile was measured at 39 degrees by conducting an interface direct shear test. The factored resisting force is calculated in equation 99.

$$R_R = \Phi_\tau(W_{t,R}\mu) = 1(18819)\tan(39) = 15239\ \text{lb/ft} \quad (99)$$

This resisting force (15,239 lb/ft) is greater than the driving force (14,068 lb/ft); therefore, direct sliding is not an issue.

C.3.6.2 Bearing Capacity

Before calculating the factored applied vertical bearing pressure, the factored eccentricity of the resulting force at the base of the wall must be calculated.

The moments are calculated around the center of the base of the RSF. The driving moments (calculated as a counterclockwise moment) include the lateral force due to the retained backfill, the road base DL, and the roadway LL and are calculated in equation 100.

$$\Sigma M_D = 1.5 \left[5258 \left(\frac{15.58}{3} \right) \right] + 1.5 \left[2165 \left(\frac{15.58}{2} \right) \right] + 1.75 \left[1676 \left(\frac{15.58}{2} \right) \right] = 89106\ \text{ft lb/ft} \quad (100)$$

The resisting moments (calculated as a clockwise moment) include the vertical force due to the bridge and road base DLs and the bridge and roadway LLs. The resisting moments are calculated in equation 101. The weight of the GRS abutment is also included as a resisting moment.

$$\Sigma M_R = (1.25 * 2600 * 4 + 1.75 * 1400 * 4) \left[\left(\frac{4}{2} + 0.67 \right) - \left(\frac{7.5}{2} - 1.5 - 0.64 \right) \right] \\ + (1.75 * 298 * 0.7 + 1.5 * 385 * 0.7) \left(\frac{7.5}{2} - \frac{0.7}{2} \right) + (1.35 * 9059 \left(\frac{7.5}{2} - \frac{5.4}{2} \right)) \\ = 39625\ \text{ft lb/ft} \quad (101)$$

The total vertical load is equal to the sum of the weight of the GRS abutment, the weight of the RSF, and the load due to the DLs (bridge and road base) and the LLs (bridge and roadway). The total vertical load is calculated in equation 102.

$$\sum V_R = 1.35(9257) + 1.35(1575) + 1.25(768) + 1.75 * 298(0.7) + 1.5 * 385(0.7) + 1.25 * 2600(4) + 1.75 * 1400(4) = 39153 \text{ lb/ft} \quad (102)$$

The eccentricity of the resulting force at the base of the RSF is then calculated in equation 103.

$$e_{B,R} = \frac{\sum M_D - \sum M_R}{\sum V_R} = \frac{89106 - 36296}{39153} = 1.26 \text{ ft} \quad (103)$$

The vertical pressure is a result of the weight of the GRS mass, the bridge seat load, and the traffic surcharge and is calculated in equation 104.

$$\sigma_{v,base,n} = \frac{\sum V_R}{B - 2e_{B,R}} = \frac{39153}{7.5 - 2(1.26)} = 7862 \text{ lb/ft}^2 \quad (104)$$

The nominal bearing capacity is then calculated in equation 105. The degrees bearing capacity factors (N_c and N_γ) were found using table 4 for the foundation friction angle of 0.

$$\begin{aligned} q_n &= c_f N_c + \frac{1}{2} B' \gamma_f N_\gamma + \gamma_f D_f N_q \\ &= 4000(5.14) + \frac{1}{2} (7.5 - 2 * 1.16)(120)(0) + 120(1.5)(1.0) \\ &= 20740 \text{ psf} \end{aligned} \quad (105)$$

Applying the resistance factor of 0.65 to the nominal bearing capacity, the factored bearing capacity (q_R) is equal to 13,481 psf. The factored bearing capacity is greater than the factored vertical pressure (7,862 psf), so bearing capacity is not an issue in this case.

C.3.6.3 Global Stability

Global and compound stability was checked using the software program ReSSA. Global stability is not a problem.

C.3.7 Step 7—Conduct Internal Stability Analysis

C.3.7.1 Vertical Capacity

The ultimate capacity of a GRS abutment can be determined using two different methods: empirical or analytical.

C.3.7.1.1 Empirical Method: The empirical method uses the results of a performance test on a GRS composite material identical (or very similar) to that used in the field. The ultimate vertical capacity is found by looking at the applicable stress-strain curve from the performance test for a

vertical strain of 5 percent (see figure 32). The capacity ($q_{n,emp}$) is equal to 26 ksf. Note that the linear line extension shown in figure 32 is to project the capacity to 5 percent.

The factored applied pressure on the GRS mass ($V_{applied,f}$) is found in equation 106:

$$V_{applied,f} = \gamma_{DC\ MAX} q_b + \gamma_{LL} q_{LL} = 1.25(2600) + 1.75(1400) = 5700 \frac{\text{lb}}{\text{ft}^2} \quad (106)$$

The ratio of the factored vertical capacity (with a resistance factor of 0.45) to the factored applied pressure ($V_{applied,f}$) must be greater than or equal to 1, as shown in equation 107.

$$\frac{\Phi_{cap}(q_{n,emp})}{V_{applied,f}} = \frac{0.45(26000)}{5700} = 2.1 \geq 1.0 \quad (107)$$

C.3.7.1.2 Analytical Method: Alternatively, the nominal capacity is found analytically for a granular backfill, where S_v is equal to 8 inches, d_{max} is equal to 0.5 inches, T_f is equal to 4,800 lb/ft, and ϕ_r is equal to 48 degrees. Note that although the spacing under the bridge bearing area is 4 inches, 8 inches was chosen to be conservative in the calculation for the entire mass.

$$q_{n,an} = \left[0.7 \left(\frac{S_v}{6d_{max}} \right) \frac{T_f}{S_v} \right] K_{pr} = \left[0.7 \left(\frac{8}{6(0.5)} \right) \frac{4800}{0.67} \right] 6.786 = 18781 \text{ lb/ft}^2 \quad (108)$$

Where the coefficient of passive earth pressure for the reinforced fill (K_{pr}) is found in equation 109.

$$K_{pr} = \frac{1 + \sin\phi_r}{1 - \sin\phi_r} = \frac{1 + \sin 48}{1 - \sin 48} = 6.786 \quad (109)$$

The factored applied pressure on the GRS mass ($V_{applied,f}$) is found in equation 110.

$$V_{applied,f} = \gamma_{DC\ MAX} q_b + \gamma_{LL} q_{LL} = 1.25(2600) + 1.75(1400) = 5700 \frac{\text{lb}}{\text{ft}^2} \quad (110)$$

The ratio of the factored ultimate capacity (with a resistance factor of 0.45) to the factored applied pressure ($V_{applied,f}$) must be less than 1, as shown in equation 111.

$$\frac{\Phi_{cap,an}(q_{n,an})}{V_{applied,f}} = \frac{0.45(18781)}{5700} = 1.5 \geq 1.0 \quad (111)$$

C.3.7.2 Deformations

C.3.7.2.1 Vertical Deformation: The vertical strain is estimated by using figure 33 for the total bridge load (q_b) of 2,600 lb/ft². The vertical strain is, therefore, about 0.3 percent—under the tolerable limit of 0.5 percent. Note that the road base surcharge is not included because it does not act over the same location.

The vertical deformation is the product of the vertical strain and the height of the GRS mass and is calculated in equation 112.

$$D_v = \varepsilon_v H = 0.003(15.58) = 0.047 \text{ ft} \quad (112)$$

C.3.7.2.2 Lateral Deformation: The lateral strain and deformation are found in equation 113 and equation 114.

$$\varepsilon_L = 2\varepsilon_v = 2(0.3\%) = 0.6\% \quad (113)$$

$$D_L = \frac{2D_v}{H}(b + a_b) = \frac{2(0.047)}{15.58}(4 + 0.67) = 0.028 \text{ ft} \quad (114)$$

C.3.7.3 Required Reinforcement Strength

The strength of the reinforcement used at Bowman Road Bridge is 4,800 lb/ft. Applying a resistance factor (ϕ_{reinf}) of 0.4, the factored reinforcement strength ($T_{f,f}$) is 1,920 lb/ft. According to the manufacturer, $T_{@ \varepsilon=2\%}$ is equal to 1,370 lb/ft. The maximum required reinforcement strength is found as a function of depth, as shown in equation 115.

$$T_{req,f} = \left[\frac{\sigma_{h,f} - \sigma_c}{0.7 \left(\frac{S_v}{6d_{max}} \right)} \right] S_v \quad (115)$$

The factored lateral stress ($\sigma_{h,f}$) is a combination of the factored lateral stresses due to the road base DL ($\sigma_{h,rb,f}$), the roadway LL ($\sigma_{h,t,f}$), the GRS reinforced soil ($\sigma_{h,W,f}$), and an equivalent bridge load ($\sigma_{h,bridge,f}$). To simplify calculations, the roadway LL and road base DL can be extended across the abutment. The vertical components of these loads are then subtracted from the bridge DL and LL, giving an equivalent bridge load. The lateral stresses due to the equivalent bridge load are then calculated according to Boussinesq theory. The lateral stress is calculated for each depth of interest (each layer of reinforcement). All lateral stresses are calculated in table 18.

An example calculation for the required reinforcement strength at a depth (z) of 5.3 ft (the eighth reinforcement layer from the top) is shown in equation 116. First, the lateral pressure must be found. Remember, the location of interest is directly under the centerline of the bridge load (where $x = 0.5b = 0.5(4\text{ft}) = 2 \text{ ft}$).

$$\sigma_{h,f} = \sigma_{h,W,f} + \sigma_{h,bridge,f} + \sigma_{h,rb,f} + \sigma_{h,t,f} = 117 + 297 + 85 + 77 = 576 \frac{\text{lb}}{\text{ft}^2} \quad (116)$$

Where the lateral pressure is found using equation 117 through equation 120.

$$\sigma_{h,W,f} = \gamma_{EH \text{ MAX}}(\gamma_r z K_{ar}) = 1.35 \left[110(5) \left(\frac{1 - \sin(48\text{deg})}{1 + \sin(48\text{deg})} \right) \right] = 117 \frac{\text{lb}}{\text{ft}^2} \quad (117)$$

$$\begin{aligned}\sigma_{h,bridge,f} &= \frac{(\gamma_{DC\ MAX} q_b + \gamma_{LL} q_{LL}) - (\gamma_{ES\ MAX} q_{rb} + \gamma_{LS} q_t)}{\pi} [\alpha_b + \sin(\alpha_b) \cos(\alpha_b + 2\beta_b)] K_{ar} \\ &= \frac{(1.25 * 2600 + 1.75 * 1400) - (1.5 * 385 + 1.75 * 298)}{\pi} [0.72rad \\ &\quad + \sin(0.72rad) \cos(0.72rad + 2 * -0.36rad)] 0.147 = 297 \frac{lb}{ft^2}\end{aligned}\quad (118)$$

$$\sigma_{h,rb} = \gamma_{ES\ MAX} q_{rb} K_{ar} = 1.5(385)(0.147) = 85 \frac{lb}{ft^2}\quad (119)$$

$$\sigma_{h,t} = \gamma_{LS} q_t K_{ar} = 1.75(298)(0.147) = 77 \frac{lb}{ft^2}\quad (120)$$

The values for α and β are found in equation 121 and 122.

$$\alpha_b = \tan^{-1}\left(\frac{b}{2z}\right) - \beta_b = \tan^{-1}\left(\frac{4}{2(5.3)}\right) - 20.7deg = 41.3deg = 0.72rad\quad (121)$$

$$\beta_b = \tan^{-1}\left(\frac{-b}{2z}\right) = \tan^{-1}\left(\frac{-4}{2(5.3)}\right) = -20.7deg = -0.36rad\quad (122)$$

The lateral earth pressure and required reinforcement strength should be found along the entire depth of the wall. The reinforcement spacing (S_v) for the required reinforcement strength calculation is 4 inches where secondary reinforcement layers are present and 8 inches where there are no secondary reinforcement layers. The depth at which secondary reinforcement layers are present is determined by applying the 8-inch reinforcement spacing for the entire height of the GRS mass. The depth at which the required reinforcement spacing does not exceed the factored reinforcement capacity of 1,920 lb/ft is the depth above which 4-inch spacing is required (see table 18).

Table 18. Depth of bearing bed reinforcement calculations (LRFD).

z (ft)	α	β	$\sigma_{h,bridge}$ (psf)	$\sigma_{h,rb}$ (psf)	$\sigma_{h,t}$ (psf)	$\sigma_{h,w}$ (psf)	$\sigma_{h,total,f}$ (psf)	$\sigma_{h,total}$ (psf)	T_{req} (lb/ft)	T_{req} > $T_{f,f}$	T_{req} (lb/ft)	T_{req} > $T@2\%$
0.7	2.5	-1.2	669	85	77	15	845	592	1458	NO	1022	NO
1.3	2.0	-1.0	623	85	77	29	814	566	1406	NO	976	NO
2.0	1.6	-0.8	555	85	77	44	760	519	1312	NO	895	NO
2.7	1.3	-0.6	485	85	77	58	705	470	1217	NO	811	NO
3.3	1.1	-0.5	424	85	77	73	659	428	1136	NO	739	NO
4.0	0.9	-0.5	373	85	77	88	622	395	1074	NO	682	NO
4.7	0.8	-0.4	331	85	77	102	595	370	1027	NO	638	NO
5.3	0.7	-0.4	297	85	77	117	575	350	993	NO	605	NO
6.0	0.6	-0.3	268	85	77	131	562	336	969	NO	580	NO
6.7	0.6	-0.3	245	85	77	146	552	326	953	NO	563	NO
7.3	0.5	-0.3	225	85	77	160	547	319	944	NO	551	NO
8.0	0.5	-0.2	207	85	77	175	544	315	939	NO	543	NO
8.7	0.5	-0.2	192	85	77	190	544	312	939	NO	539	NO
9.3	0.4	-0.2	180	85	77	204	546	312	942	NO	538	NO
10.0	0.4	-0.2	168	85	77	219	549	312	947	NO	539	NO
10.7	0.4	-0.2	158	85	77	233	553	314	955	NO	542	NO
11.3	0.3	-0.2	149	85	77	248	559	317	965	NO	547	NO
12.0	0.3	-0.2	141	85	77	263	566	321	976	NO	554	NO
12.7	0.3	-0.2	134	85	77	277	573	325	989	NO	561	NO
13.3	0.3	-0.1	128	85	77	292	581	330	1003	NO	570	NO
14.0	0.3	-0.1	122	85	77	306	590	336	1018	NO	579	NO
14.7	0.3	-0.1	116	85	77	321	599	342	1034	NO	590	NO

Based on table 18, the required reinforcement strength does not exceed the allowable strength or the strength at 2 percent at any reinforcement layer. Therefore, no bearing bed reinforcement is needed. However, the minimum requirement is that the bearing bed reinforcement should extend through five courses of blocks. In actuality, six courses of block were chosen to extend the bearing reinforcement bed in this case (to a depth of 4 ft below the top of the wall). This was chosen to be conservative since this was the first bridge built with GRS technology. There should, therefore, be no issues with reinforcement strength in the abutment.

C.3.8 Step 8—Implement Design Details

All design details were considered. Since it is a skewed bridge, a bearing area of 3 ft was maintained along the length of the face wall. The bearing bed reinforcement schedule was also maintained across the abutment face due to the superelevation (see figure 35).

APPENDIX D. TYPICAL GRS-IBS WORKING DRAWINGS

D.1 SINGLE-PAGE PLAN SHEET

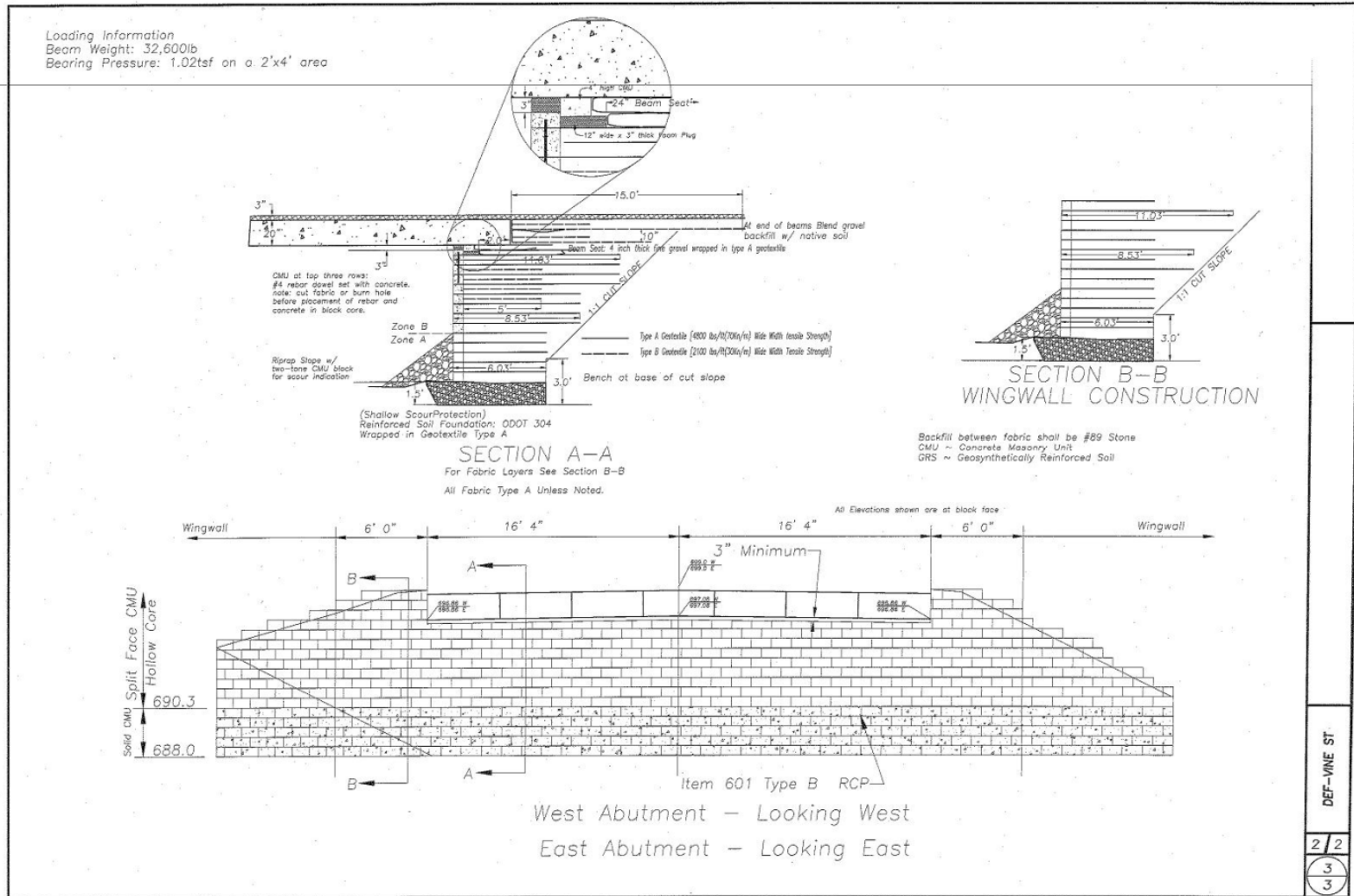

Figure 100. Illustration. Single-page plan sheet.

D.2 ESTIMATED QUANTITIES AND GENERAL NOTES

DESIGN DATA:		GENERAL NOTES										ESTIMATED QUANTITIES																																																																																																																																																																																																																																																																																																																																																																																																																																																																																																																																																										
<p>REMOVAL OF EXISTING STRUCTURE: When no longer needed to maintain traffic, the existing structure shall be removed as directed by the Engineer. The structure shall be removed to an elevation of 753.0</p> <p>DBR-2-73 Dated 7-19-02</p> <p>DESIGN SPECIFICATIONS: This structure conforms to "Standard Specifications for Highway Bridges" adopted by the American Association of State Highway and Transportation Officials, 1996, and the ODOT Bridge Design Manual.</p> <p>DESIGN LOADING: HL93 and the Alternate Military Loading</p> <p>All abutment items shall be paid as placed to account for variation in quantities.</p> <p>Unclassified excavation shall apply to all excavation shown on the plans between stations 40+82 and 41+32 not accounted for in the roadway cross sections.</p> <p>Item 704 Splitface Concrete Masonry Block - This item shall consist of furnishing and placing splitface Hollow Core Concrete Masonry Units (CMU) meeting ASTM C90 with the modifications that the block shall have a minimum compressive strength of 4000 psi and a maximum absorption rate of 6.5%. Place CMU blocks side by side for the full length of each course of the wall. Check wall plumbness a minimum of every 3 layers and correct deviations greater than 1/4". Correct misaligned, improperly seated or out of level CMU blocks. Assume that the tops of all CMU blocks are free of loose material prior to the placement of the next layer of geotextile and CMU blocks. This block is designated to be used in Zone B as shown on page 15.</p> <p>Item 704 Solid Concrete Masonry Block - This item shall consist of furnishing and placing solid Concrete Masonry Units (CMU) colored red meeting ASTM C90 with the modifications that the block shall have a minimum compressive strength of 4000 psi and a maximum absorption rate of 6.5%. Begin construction of the abutment by placing one full length course of CMU block at a time. Place the first course of CMU block on top and in full contact with the Reinforced Soil Foundation. The first row of CMU block must be carefully leveled in both directions to provide a firm preparation for the balance of the wall. Check wall plumbness a minimum of every 3 layers and correct deviations greater than 1/4". Correct misaligned, improperly seated or out of level CMU blocks. Assume that the tops of all CMU blocks are free of loose material prior to the placement of the next layer of geotextile and CMU blocks. This block is designated to be used in Zone A as shown on page 15.</p> <p>Item Special High Strength Woven Polypropylene Fabric - This item shall have a Wide Width Tensile strength of 4800/lb per foot in both directions as per ASTM D-4595. The geosynthetic reinforcement shall be placed as shown on sheet 15. The width and length vary as shown on the drawing and reinforcement schedule. Geosynthetic reinforcement shall extend between the layers of CMU block to provide a frictional connection. The geosynthetic reinforcement shall nearly completely cover the top of the CMU block. Pull the geosynthetic reinforcement taut prior to backfilling to remove wrinkles. The price bid shall include furnishing and placing this material. To limit construction damage to the geotextile reinforcement, construction equipment shall not drive directly over the geotextile. An aggregate thickness of 6" is sufficient to prevent equipment from damaging the geotextile. No lapping of fabric shall be permitted along the face. Where lapped elsewhere a 0.25" thickness of stone shall be spread between pieces of fabric.</p> <p>Item Special Medium Strength Woven Polypropylene Fabric - This item shall have a Wide Width Tensile strength of 2400/lb per foot in both directions as per ASTM D-4595. The geosynthetic reinforcement shall be placed as shown on sheet 15. The width and length vary as shown on the drawing and reinforcement schedule. Geosynthetic reinforcement shall extend to the back of layers of CMU block without connection. Pull the geosynthetic reinforcement taut prior to backfilling to remove wrinkles. The price bid shall include furnishing and placing this material. To limit construction damage to the geotextile reinforcement, construction equipment shall not drive directly over the geotextile. An aggregate thickness of 6" is sufficient to prevent equipment from damaging the geotextile.</p> <p>Item 203 Granular Embankment #89 Stone - This item shall include furnishing and placing Coarse Aggregate conforming to the #89 gradation. The stone backfill shall be placed behind each layer of CMU block in a lift thickness not to exceed the CMU block height. Placement of the aggregate shall be from the wall face backward to prevent the formation of and to remove any wrinkles in the geotextile. Fill shall be placed in a manner to avoid wrinkling of the geosynthetic reinforcement. The backfill shall be completely compacted as per 203.07. This is generally achieved by: 1) rading the aggregate fill behind each CMU block approximately every foot while exerting downward pressure on the CMU block to prevent lateral movement 2) using a vibratory plate compactor (> 4 passes) directly behind the CMU block while exerting downward pressure on the CMU block to prevent lateral movement 3) Larger vibratory compactors may be used for the balance of the area more than 2' behind the CMU block. Multiple passes of a vibratory plate compactor can also achieve the proper density</p> <p>At the end of a day's operations, slope the last lift of backfill away from the wall face to direct surface runoff away from the wall. Do not allow surface runoff from adjacent areas to enter the wall construction area.</p> <p>Item 203 Granular Embankment #304 Stone - This item shall include furnishing and placing Coarse Aggregate conforming to the ODOT 304 gradation. The stone backfill shall be placed in compactor lifts not to exceed 9". The backfill shall be compacted as per 203.07. The bottom of the excavation shall be sound soil as determined by the engineer. If additional excavation is required it shall be included in the unit price bid for this item. This item shall be paid as placed. If the Reinforced soil foundation is thicker than 18" an intermediate fabric layer shall be placed and paid for at the unit price bid.</p> <p>Item 511 Class C Concrete - This item shall include providing and placing Class C Concrete proportioned per Table 499.03-3 using #8 site Coarse Aggregate. All CMU block shall have the fabric cut or removed to allow the voids to be tied together to a depth of 3 full block. A piece of #4 rebar shall be placed in each void. This will likely have to be done in at least 2 separate pours as the voids below the beams must be filled before beam placement and the voids in the balance must be poured after beam placement. The top of any exposed concrete must be shaped to shed water. The cost for the concrete, placing, rebar and fabric preparation shall be included in the unit price bid for Class C Concrete, As Per Plan.</p> <p>Item Special Beam Seat Construction - This item shall include all materials and labor not included in other pay items including but not limited to foam and aluminum fascia, needed to complete the beam seat detail 10. The fabric, stone and CMU block used in the beam seat pads shall be paid for under their respective items.</p>		<p>DOMESTIC STEEL USE REQUIREMENTS AS SPECIFIED IN SECTION 133.011 OF THE REVISION CODE APPLY TO THIS PROJECT. COPIES OF SECTION 133.011 OF THE REVISION CODE CAN BE OBTAINED FROM ANY OF THE OFFICES OF THE DEPARTMENT OF ADMINISTRATIVE SERVICES.</p>										<p>GRS Abutment Quantities</p> <table border="1"> <thead> <tr> <th>Layer</th> <th>Main Fabric Length Width SY</th> <th>Face Block Solids CMU</th> <th>Sec. Fabric Solids CMU</th> <th>E-WW Block Solids CMU</th> <th>W-WW Block Solids CMU</th> <th>E-WW Fabric Length Width SY</th> <th>W-WW Fabric Length Width SY</th> <th>#89 SE CY</th> <th>304 E CY</th> <th>304 W CY</th> <th>304 Main CY</th> </tr> </thead> <tbody> <tr><td>RSF</td><td>44.5' 18'</td><td>89</td><td></td><td></td><td></td><td>25.5' 18'</td><td>76.5' 27.1'</td><td>81.3</td><td>8.5</td><td>9.6</td><td>16.9</td></tr> <tr><td>1</td><td>36.5' 6'</td><td>25.7</td><td>29.5</td><td></td><td>36</td><td>38</td><td>35' 6'</td><td>23.3</td><td>37.6'</td><td>6'</td><td>25.0</td><td>7.6</td></tr> <tr><td>2</td><td>36.5' 6'</td><td>25.7</td><td>29.5</td><td></td><td>36</td><td>38</td><td>35' 6'</td><td>23.3</td><td>37.6'</td><td>6'</td><td>25.0</td><td>7.6</td></tr> <tr><td>3</td><td>36.5' 6'</td><td>25.7</td><td>29.5</td><td></td><td>36</td><td>38</td><td>35' 6'</td><td>23.3</td><td>37.6'</td><td>6'</td><td>25.0</td><td>7.6</td></tr> <tr><td>4</td><td>36.5' 6'</td><td>25.7</td><td>29.5</td><td></td><td>36</td><td>38</td><td>35' 6'</td><td>23.3</td><td>37.6'</td><td>6'</td><td>25.0</td><td>7.6</td></tr> <tr><td>5</td><td>36.5' 6'</td><td>25.7</td><td>29.5</td><td></td><td>36</td><td>38</td><td>35' 6'</td><td>23.3</td><td>37.6'</td><td>6'</td><td>25.0</td><td>10.1</td></tr> <tr><td>6</td><td>36.5' 6.5'</td><td>36.4</td><td>29.5</td><td></td><td>36</td><td>38</td><td>30' 6'</td><td>20.0</td><td>32.6'</td><td>6'</td><td>20.0</td><td>10.8</td></tr> <tr><td>7</td><td>36.5' 6.5'</td><td>36.4</td><td>29.5</td><td></td><td>36</td><td>38</td><td>30' 6.5'</td><td>28.3</td><td>32.6'</td><td>6.5'</td><td>28.3</td><td>11.6</td></tr> <tr><td>8</td><td>36.5' 6.5'</td><td>36.4</td><td>29.5</td><td></td><td>36</td><td>38</td><td>30' 6'</td><td>20.0</td><td>32.6'</td><td>6'</td><td>20.0</td><td>12.3</td></tr> <tr><td>9</td><td>36.5' 6.5'</td><td>36.4</td><td>29.5</td><td></td><td>36</td><td>38</td><td>30' 6.5'</td><td>28.3</td><td>32.6'</td><td>6.5'</td><td>28.3</td><td>13.0</td></tr> <tr><td>10</td><td>36.5' 11'</td><td>47.1</td><td>29.5</td><td></td><td>36</td><td>38</td><td>25'</td><td>16.7</td><td>27.6'</td><td>11'</td><td>30.6</td><td>15.7</td></tr> <tr><td>11</td><td>36.5' 11'</td><td>47.1</td><td>29.5</td><td></td><td>36</td><td>38</td><td>25'</td><td>16.7</td><td>27.6'</td><td>11'</td><td>30.6</td><td>14.4</td></tr> <tr><td>12</td><td>36.5' 11'</td><td>47.1</td><td>29.5</td><td></td><td>36</td><td>38</td><td>25'</td><td>16.7</td><td>27.6'</td><td>11'</td><td>30.6</td><td>15.0</td></tr> <tr><td>13</td><td>36.5' 11'</td><td>47.1</td><td>29.5</td><td></td><td>36</td><td>38</td><td>25'</td><td>16.7</td><td>27.6'</td><td>11'</td><td>30.6</td><td>15.7</td></tr> <tr><td>14</td><td>36.5' 11'</td><td>47.1</td><td>29.5</td><td></td><td>36</td><td>38</td><td>25'</td><td>16.7</td><td>27.6'</td><td>11'</td><td>30.6</td><td>16.3</td></tr> <tr><td>15</td><td>36.5' 11'</td><td>47.1</td><td>29.5</td><td></td><td>36</td><td>38</td><td>25'</td><td>16.7</td><td>27.6'</td><td>11'</td><td>30.6</td><td>16.9</td></tr> <tr><td>16</td><td>36.5' 11'</td><td>47.1</td><td>29.5</td><td></td><td>36</td><td>38</td><td>25'</td><td>16.7</td><td>27.6'</td><td>11'</td><td>30.6</td><td>15.7</td></tr> <tr><td>17</td><td>36.5' 11'</td><td>47.1</td><td>29.5</td><td></td><td>36</td><td>38</td><td>25'</td><td>16.7</td><td>27.6'</td><td>11'</td><td>30.6</td><td>17.9</td></tr> <tr><td>18</td><td>36.5' 11'</td><td>47.1</td><td>29.5</td><td>36'</td><td>23.0</td><td>36</td><td>38</td><td>25'</td><td>16.7</td><td>27.6'</td><td>11'</td><td>16.5</td></tr> <tr><td>19</td><td>36.5' 11'</td><td>47.1</td><td>29.5</td><td>36'</td><td>23.0</td><td>36</td><td>38</td><td>25'</td><td>16.7</td><td>27.6'</td><td>11'</td><td>19.0</td></tr> <tr><td>20</td><td>36.5' 11'</td><td>47.1</td><td>29.5</td><td>36'</td><td>23.0</td><td>36</td><td>38</td><td>11'</td><td>11'</td><td>22.0</td><td>13.6'</td><td>11'</td><td>22.0</td><td>19.5</td></tr> <tr><td>21</td><td>36.5' 18'</td><td>77.0</td><td>29.5</td><td>36'</td><td>23.0</td><td>36</td><td>38</td><td>11'</td><td>18'</td><td>22.0</td><td>13.6'</td><td>18'</td><td>22.0</td><td>19.9</td></tr> <tr><td>22</td><td>36.5' 18'</td><td>77.0</td><td>29.5</td><td>36'</td><td>23.0</td><td>36</td><td>38</td><td>11'</td><td>18'</td><td>22.0</td><td>13.6'</td><td>18'</td><td>22.0</td><td>20.4</td></tr> <tr><td>23</td><td>36.5' 18'</td><td>77.0</td><td>29.5</td><td></td><td></td><td>36</td><td>38</td><td>11'</td><td>18'</td><td>22.0</td><td>13.6'</td><td>18'</td><td>22.0</td><td>20.8</td></tr> <tr><td>24</td><td>4'</td><td>2.2</td><td>29.5</td><td></td><td></td><td>36</td><td>38</td><td></td><td></td><td></td><td></td><td></td><td></td><td>21.2</td></tr> <tr><td>25</td><td></td><td></td><td>7.0</td><td></td><td></td><td></td><td></td><td></td><td></td><td></td><td></td><td></td><td></td><td>21.8</td></tr> <tr><td>26</td><td></td><td></td><td>6.0</td><td></td><td></td><td></td><td></td><td></td><td></td><td></td><td></td><td></td><td></td><td></td></tr> <tr><td>Beam Seat</td><td>2@30' 11'</td><td>73.3</td><td></td><td></td><td></td><td></td><td></td><td></td><td></td><td></td><td></td><td></td><td></td><td></td></tr> <tr><td>Beam Fill</td><td>2@30' 18'</td><td>120</td><td>47.1</td><td></td><td></td><td></td><td></td><td></td><td></td><td></td><td></td><td></td><td></td><td></td></tr> <tr><td>E. Abutment</td><td></td><td>1114</td><td>147.5</td><td>573.5</td><td>115</td><td>180</td><td>684</td><td></td><td></td><td>614</td><td></td><td></td><td>379</td><td>8.5</td><td></td><td>16.9</td></tr> <tr><td>W. Abutment</td><td></td><td>1114</td><td>147.5</td><td>573.5</td><td>115</td><td></td><td>180</td><td>722</td><td></td><td></td><td></td><td></td><td>627.4</td><td>379</td><td>9.6</td><td>16.9</td></tr> <tr><td>Add for extra length of W. Abutment</td><td></td><td></td><td></td><td></td><td></td><td></td><td></td><td></td><td></td><td></td><td></td><td></td><td></td><td></td><td></td><td></td></tr> <tr><td>Subtotals</td><td></td><td>2228</td><td>295</td><td>1147</td><td>230</td><td>180</td><td>684</td><td>190</td><td>722</td><td>614</td><td></td><td></td><td>627.4</td><td>767.8</td><td>8.5</td><td>9.6</td><td>33.8</td></tr> <tr><td>Total Solid Concrete Masonry Block</td><td></td><td></td><td></td><td></td><td>665</td><td>Each</td><td></td><td>Total Medium Strength Polypropylene Fabric</td><td></td><td></td><td></td><td>230</td><td>SY</td><td></td><td></td><td></td><td></td></tr> <tr><td>Total Split Face Concrete Masonry Block</td><td></td><td></td><td></td><td></td><td>253.3</td><td>Each</td><td></td><td>Total Granular Embankment #89 Stone</td><td></td><td></td><td></td><td>768</td><td>CY</td><td></td><td></td><td></td><td></td></tr> <tr><td>Total High Strength Polypropylene Fabric</td><td></td><td></td><td></td><td></td><td>3470</td><td>SY</td><td></td><td>Total Granular Embankment #304 Stone</td><td></td><td></td><td></td><td>52</td><td>CY</td><td></td><td></td><td></td><td></td></tr> </tbody> </table>										Layer	Main Fabric Length Width SY	Face Block Solids CMU	Sec. Fabric Solids CMU	E-WW Block Solids CMU	W-WW Block Solids CMU	E-WW Fabric Length Width SY	W-WW Fabric Length Width SY	#89 SE CY	304 E CY	304 W CY	304 Main CY	RSF	44.5' 18'	89				25.5' 18'	76.5' 27.1'	81.3	8.5	9.6	16.9	1	36.5' 6'	25.7	29.5		36	38	35' 6'	23.3	37.6'	6'	25.0	7.6	2	36.5' 6'	25.7	29.5		36	38	35' 6'	23.3	37.6'	6'	25.0	7.6	3	36.5' 6'	25.7	29.5		36	38	35' 6'	23.3	37.6'	6'	25.0	7.6	4	36.5' 6'	25.7	29.5		36	38	35' 6'	23.3	37.6'	6'	25.0	7.6	5	36.5' 6'	25.7	29.5		36	38	35' 6'	23.3	37.6'	6'	25.0	10.1	6	36.5' 6.5'	36.4	29.5		36	38	30' 6'	20.0	32.6'	6'	20.0	10.8	7	36.5' 6.5'	36.4	29.5		36	38	30' 6.5'	28.3	32.6'	6.5'	28.3	11.6	8	36.5' 6.5'	36.4	29.5		36	38	30' 6'	20.0	32.6'	6'	20.0	12.3	9	36.5' 6.5'	36.4	29.5		36	38	30' 6.5'	28.3	32.6'	6.5'	28.3	13.0	10	36.5' 11'	47.1	29.5		36	38	25'	16.7	27.6'	11'	30.6	15.7	11	36.5' 11'	47.1	29.5		36	38	25'	16.7	27.6'	11'	30.6	14.4	12	36.5' 11'	47.1	29.5		36	38	25'	16.7	27.6'	11'	30.6	15.0	13	36.5' 11'	47.1	29.5		36	38	25'	16.7	27.6'	11'	30.6	15.7	14	36.5' 11'	47.1	29.5		36	38	25'	16.7	27.6'	11'	30.6	16.3	15	36.5' 11'	47.1	29.5		36	38	25'	16.7	27.6'	11'	30.6	16.9	16	36.5' 11'	47.1	29.5		36	38	25'	16.7	27.6'	11'	30.6	15.7	17	36.5' 11'	47.1	29.5		36	38	25'	16.7	27.6'	11'	30.6	17.9	18	36.5' 11'	47.1	29.5	36'	23.0	36	38	25'	16.7	27.6'	11'	16.5	19	36.5' 11'	47.1	29.5	36'	23.0	36	38	25'	16.7	27.6'	11'	19.0	20	36.5' 11'	47.1	29.5	36'	23.0	36	38	11'	11'	22.0	13.6'	11'	22.0	19.5	21	36.5' 18'	77.0	29.5	36'	23.0	36	38	11'	18'	22.0	13.6'	18'	22.0	19.9	22	36.5' 18'	77.0	29.5	36'	23.0	36	38	11'	18'	22.0	13.6'	18'	22.0	20.4	23	36.5' 18'	77.0	29.5			36	38	11'	18'	22.0	13.6'	18'	22.0	20.8	24	4'	2.2	29.5			36	38							21.2	25			7.0											21.8	26			6.0												Beam Seat	2@30' 11'	73.3													Beam Fill	2@30' 18'	120	47.1												E. Abutment		1114	147.5	573.5	115	180	684			614			379	8.5		16.9	W. Abutment		1114	147.5	573.5	115		180	722					627.4	379	9.6	16.9	Add for extra length of W. Abutment																	Subtotals		2228	295	1147	230	180	684	190	722	614			627.4	767.8	8.5	9.6	33.8	Total Solid Concrete Masonry Block					665	Each		Total Medium Strength Polypropylene Fabric				230	SY					Total Split Face Concrete Masonry Block					253.3	Each		Total Granular Embankment #89 Stone				768	CY					Total High Strength Polypropylene Fabric					3470	SY		Total Granular Embankment #304 Stone				52	CY				
Layer	Main Fabric Length Width SY	Face Block Solids CMU	Sec. Fabric Solids CMU	E-WW Block Solids CMU	W-WW Block Solids CMU	E-WW Fabric Length Width SY	W-WW Fabric Length Width SY	#89 SE CY	304 E CY	304 W CY	304 Main CY																																																																																																																																																																																																																																																																																																																																																																																																																																																																																																																																																											
RSF	44.5' 18'	89				25.5' 18'	76.5' 27.1'	81.3	8.5	9.6	16.9																																																																																																																																																																																																																																																																																																																																																																																																																																																																																																																																																											
1	36.5' 6'	25.7	29.5		36	38	35' 6'	23.3	37.6'	6'	25.0	7.6																																																																																																																																																																																																																																																																																																																																																																																																																																																																																																																																																										
2	36.5' 6'	25.7	29.5		36	38	35' 6'	23.3	37.6'	6'	25.0	7.6																																																																																																																																																																																																																																																																																																																																																																																																																																																																																																																																																										
3	36.5' 6'	25.7	29.5		36	38	35' 6'	23.3	37.6'	6'	25.0	7.6																																																																																																																																																																																																																																																																																																																																																																																																																																																																																																																																																										
4	36.5' 6'	25.7	29.5		36	38	35' 6'	23.3	37.6'	6'	25.0	7.6																																																																																																																																																																																																																																																																																																																																																																																																																																																																																																																																																										
5	36.5' 6'	25.7	29.5		36	38	35' 6'	23.3	37.6'	6'	25.0	10.1																																																																																																																																																																																																																																																																																																																																																																																																																																																																																																																																																										
6	36.5' 6.5'	36.4	29.5		36	38	30' 6'	20.0	32.6'	6'	20.0	10.8																																																																																																																																																																																																																																																																																																																																																																																																																																																																																																																																																										
7	36.5' 6.5'	36.4	29.5		36	38	30' 6.5'	28.3	32.6'	6.5'	28.3	11.6																																																																																																																																																																																																																																																																																																																																																																																																																																																																																																																																																										
8	36.5' 6.5'	36.4	29.5		36	38	30' 6'	20.0	32.6'	6'	20.0	12.3																																																																																																																																																																																																																																																																																																																																																																																																																																																																																																																																																										
9	36.5' 6.5'	36.4	29.5		36	38	30' 6.5'	28.3	32.6'	6.5'	28.3	13.0																																																																																																																																																																																																																																																																																																																																																																																																																																																																																																																																																										
10	36.5' 11'	47.1	29.5		36	38	25'	16.7	27.6'	11'	30.6	15.7																																																																																																																																																																																																																																																																																																																																																																																																																																																																																																																																																										
11	36.5' 11'	47.1	29.5		36	38	25'	16.7	27.6'	11'	30.6	14.4																																																																																																																																																																																																																																																																																																																																																																																																																																																																																																																																																										
12	36.5' 11'	47.1	29.5		36	38	25'	16.7	27.6'	11'	30.6	15.0																																																																																																																																																																																																																																																																																																																																																																																																																																																																																																																																																										
13	36.5' 11'	47.1	29.5		36	38	25'	16.7	27.6'	11'	30.6	15.7																																																																																																																																																																																																																																																																																																																																																																																																																																																																																																																																																										
14	36.5' 11'	47.1	29.5		36	38	25'	16.7	27.6'	11'	30.6	16.3																																																																																																																																																																																																																																																																																																																																																																																																																																																																																																																																																										
15	36.5' 11'	47.1	29.5		36	38	25'	16.7	27.6'	11'	30.6	16.9																																																																																																																																																																																																																																																																																																																																																																																																																																																																																																																																																										
16	36.5' 11'	47.1	29.5		36	38	25'	16.7	27.6'	11'	30.6	15.7																																																																																																																																																																																																																																																																																																																																																																																																																																																																																																																																																										
17	36.5' 11'	47.1	29.5		36	38	25'	16.7	27.6'	11'	30.6	17.9																																																																																																																																																																																																																																																																																																																																																																																																																																																																																																																																																										
18	36.5' 11'	47.1	29.5	36'	23.0	36	38	25'	16.7	27.6'	11'	16.5																																																																																																																																																																																																																																																																																																																																																																																																																																																																																																																																																										
19	36.5' 11'	47.1	29.5	36'	23.0	36	38	25'	16.7	27.6'	11'	19.0																																																																																																																																																																																																																																																																																																																																																																																																																																																																																																																																																										
20	36.5' 11'	47.1	29.5	36'	23.0	36	38	11'	11'	22.0	13.6'	11'	22.0	19.5																																																																																																																																																																																																																																																																																																																																																																																																																																																																																																																																																								
21	36.5' 18'	77.0	29.5	36'	23.0	36	38	11'	18'	22.0	13.6'	18'	22.0	19.9																																																																																																																																																																																																																																																																																																																																																																																																																																																																																																																																																								
22	36.5' 18'	77.0	29.5	36'	23.0	36	38	11'	18'	22.0	13.6'	18'	22.0	20.4																																																																																																																																																																																																																																																																																																																																																																																																																																																																																																																																																								
23	36.5' 18'	77.0	29.5			36	38	11'	18'	22.0	13.6'	18'	22.0	20.8																																																																																																																																																																																																																																																																																																																																																																																																																																																																																																																																																								
24	4'	2.2	29.5			36	38							21.2																																																																																																																																																																																																																																																																																																																																																																																																																																																																																																																																																								
25			7.0											21.8																																																																																																																																																																																																																																																																																																																																																																																																																																																																																																																																																								
26			6.0																																																																																																																																																																																																																																																																																																																																																																																																																																																																																																																																																																			
Beam Seat	2@30' 11'	73.3																																																																																																																																																																																																																																																																																																																																																																																																																																																																																																																																																																				
Beam Fill	2@30' 18'	120	47.1																																																																																																																																																																																																																																																																																																																																																																																																																																																																																																																																																																			
E. Abutment		1114	147.5	573.5	115	180	684			614			379	8.5		16.9																																																																																																																																																																																																																																																																																																																																																																																																																																																																																																																																																						
W. Abutment		1114	147.5	573.5	115		180	722					627.4	379	9.6	16.9																																																																																																																																																																																																																																																																																																																																																																																																																																																																																																																																																						
Add for extra length of W. Abutment																																																																																																																																																																																																																																																																																																																																																																																																																																																																																																																																																																						
Subtotals		2228	295	1147	230	180	684	190	722	614			627.4	767.8	8.5	9.6	33.8																																																																																																																																																																																																																																																																																																																																																																																																																																																																																																																																																					
Total Solid Concrete Masonry Block					665	Each		Total Medium Strength Polypropylene Fabric				230	SY																																																																																																																																																																																																																																																																																																																																																																																																																																																																																																																																																									
Total Split Face Concrete Masonry Block					253.3	Each		Total Granular Embankment #89 Stone				768	CY																																																																																																																																																																																																																																																																																																																																																																																																																																																																																																																																																									
Total High Strength Polypropylene Fabric					3470	SY		Total Granular Embankment #304 Stone				52	CY																																																																																																																																																																																																																																																																																																																																																																																																																																																																																																																																																									
<p>Item 203 Granular Embankment #89 Stone - This item shall include furnishing and placing Coarse Aggregate conforming to the #89 gradation. The stone backfill shall be placed behind each layer of CMU block in a lift thickness not to exceed the CMU block height. Placement of the aggregate shall be from the wall face backward to prevent the formation of and to remove any wrinkles in the geotextile. Fill shall be placed in a manner to avoid wrinkling of the geosynthetic reinforcement. The backfill shall be completely compacted as per 203.07. This is generally achieved by: 1) rading the aggregate fill behind each CMU block approximately every foot while exerting downward pressure on the CMU block to prevent lateral movement 2) using a vibratory plate compactor (> 4 passes) directly behind the CMU block while exerting downward pressure on the CMU block to prevent lateral movement 3) Larger vibratory compactors may be used for the balance of the area more than 2' behind the CMU block. Multiple passes of a vibratory plate compactor can also achieve the proper density</p> <p>At the end of a day's operations, slope the last lift of backfill away from the wall face to direct surface runoff away from the wall. Do not allow surface runoff from adjacent areas to enter the wall construction area.</p> <p>Item 203 Granular Embankment #304 Stone - This item shall include furnishing and placing Coarse Aggregate conforming to the ODOT 304 gradation. The stone backfill shall be placed in compactor lifts not to exceed 9". The backfill shall be compacted as per 203.07. The bottom of the excavation shall be sound soil as determined by the engineer. If additional excavation is required it shall be included in the unit price bid for this item. This item shall be paid as placed. If the Reinforced soil foundation is thicker than 18" an intermediate fabric layer shall be placed and paid for at the unit price bid.</p> <p>Item 511 Class C Concrete - This item shall include providing and placing Class C Concrete proportioned per Table 499.03-3 using #8 site Coarse Aggregate. All CMU block shall have the fabric cut or removed to allow the voids to be tied together to a depth of 3 full block. A piece of #4 rebar shall be placed in each void. This will likely have to be done in at least 2 separate pours as the voids below the beams must be filled before beam placement and the voids in the balance must be poured after beam placement. The top of any exposed concrete must be shaped to shed water. The cost for the concrete, placing, rebar and fabric preparation shall be included in the unit price bid for Class C Concrete, As Per Plan.</p> <p>Item Special Beam Seat Construction - This item shall include all materials and labor not included in other pay items including but not limited to foam and aluminum fascia, needed to complete the beam seat detail 10. The fabric, stone and CMU block used in the beam seat pads shall be paid for under their respective items.</p>		<p>ESTIMATED QUANTITIES</p> <table border="1"> <thead> <tr> <th>Item</th> <th>Total</th> <th>Unit</th> <th>Description</th> <th>Super.</th> <th>Abut.</th> <th>Gen'l.</th> </tr> </thead> <tbody> <tr><td>202</td><td>Lump</td><td></td><td>Structure Removed</td><td></td><td></td><td>Lump</td></tr> <tr><td>503</td><td>Lump</td><td></td><td>Unclassified Excavation</td><td></td><td></td><td>Lump</td></tr> <tr><td>448</td><td>5.8</td><td>Tons</td><td>Asphalt Concrete Surface Course, Type 1, PG64-22</td><td>5.8</td><td></td><td></td></tr> <tr><td>448</td><td>7.0</td><td>Tons</td><td>Asphalt Concrete Intermediate Course, Type 1, PG64-22</td><td>7.0</td><td></td><td></td></tr> <tr><td>512</td><td>Lump</td><td></td><td>Type 3 Waterproofing</td><td></td><td></td><td>Lump</td></tr> <tr><td>515</td><td>7</td><td>Each</td><td>Prestressed Concrete Non-composite Box Beam Bridge Members (B17-48) Level 1</td><td></td><td></td><td>7</td></tr> <tr><td>Special</td><td>54</td><td>Foot</td><td>Stainless Steel Drip Strip</td><td>54</td><td></td><td></td></tr> <tr><td>704</td><td>2553</td><td>Each</td><td>Splitface Concrete Masonry Block</td><td></td><td></td><td>2553</td></tr> <tr><td>704</td><td>665</td><td>Each</td><td>Solid Concrete Masonry Block</td><td></td><td></td><td>665</td></tr> <tr><td>Special</td><td>3470</td><td>SY</td><td>High Strength Woven Polypropylene Fabric</td><td></td><td></td><td>3470</td></tr> <tr><td>Special</td><td>230</td><td>SY</td><td>Medium Strength Woven Polypropylene Fabric</td><td></td><td></td><td>230</td></tr> <tr><td>203</td><td>768</td><td>CY</td><td>Granular Embankment #89 Stone</td><td></td><td></td><td>768</td></tr> <tr><td>203</td><td>52</td><td>CY</td><td>Granular Embankment #304 Stone</td><td></td><td></td><td>52</td></tr> <tr><td>511</td><td>4.70</td><td>CY</td><td>Class C Concrete, As per Plan</td><td></td><td></td><td>4.70</td></tr> <tr><td>Special</td><td>Lump</td><td></td><td>Beam Seat Construction</td><td></td><td></td><td>Lump</td></tr> <tr><td>517</td><td>50</td><td>Foot</td><td>Railing (Deep Beam Rail with Steel Tubular Backup and Type 2 Steel Post and Anchor Bolts)</td><td>50</td><td></td><td></td></tr> </tbody> </table>										Item	Total	Unit	Description	Super.	Abut.	Gen'l.	202	Lump		Structure Removed			Lump	503	Lump		Unclassified Excavation			Lump	448	5.8	Tons	Asphalt Concrete Surface Course, Type 1, PG64-22	5.8			448	7.0	Tons	Asphalt Concrete Intermediate Course, Type 1, PG64-22	7.0			512	Lump		Type 3 Waterproofing			Lump	515	7	Each	Prestressed Concrete Non-composite Box Beam Bridge Members (B17-48) Level 1			7	Special	54	Foot	Stainless Steel Drip Strip	54			704	2553	Each	Splitface Concrete Masonry Block			2553	704	665	Each	Solid Concrete Masonry Block			665	Special	3470	SY	High Strength Woven Polypropylene Fabric			3470	Special	230	SY	Medium Strength Woven Polypropylene Fabric			230	203	768	CY	Granular Embankment #89 Stone			768	203	52	CY	Granular Embankment #304 Stone			52	511	4.70	CY	Class C Concrete, As per Plan			4.70	Special	Lump		Beam Seat Construction			Lump	517	50	Foot	Railing (Deep Beam Rail with Steel Tubular Backup and Type 2 Steel Post and Anchor Bolts)	50																																																																																																																																																																																																																																																																																																																																																																																																																																						
Item	Total	Unit	Description	Super.	Abut.	Gen'l.																																																																																																																																																																																																																																																																																																																																																																																																																																																																																																																																																																
202	Lump		Structure Removed			Lump																																																																																																																																																																																																																																																																																																																																																																																																																																																																																																																																																																
503	Lump		Unclassified Excavation			Lump																																																																																																																																																																																																																																																																																																																																																																																																																																																																																																																																																																
448	5.8	Tons	Asphalt Concrete Surface Course, Type 1, PG64-22	5.8																																																																																																																																																																																																																																																																																																																																																																																																																																																																																																																																																																		
448	7.0	Tons	Asphalt Concrete Intermediate Course, Type 1, PG64-22	7.0																																																																																																																																																																																																																																																																																																																																																																																																																																																																																																																																																																		
512	Lump		Type 3 Waterproofing			Lump																																																																																																																																																																																																																																																																																																																																																																																																																																																																																																																																																																
515	7	Each	Prestressed Concrete Non-composite Box Beam Bridge Members (B17-48) Level 1			7																																																																																																																																																																																																																																																																																																																																																																																																																																																																																																																																																																
Special	54	Foot	Stainless Steel Drip Strip	54																																																																																																																																																																																																																																																																																																																																																																																																																																																																																																																																																																		
704	2553	Each	Splitface Concrete Masonry Block			2553																																																																																																																																																																																																																																																																																																																																																																																																																																																																																																																																																																
704	665	Each	Solid Concrete Masonry Block			665																																																																																																																																																																																																																																																																																																																																																																																																																																																																																																																																																																
Special	3470	SY	High Strength Woven Polypropylene Fabric			3470																																																																																																																																																																																																																																																																																																																																																																																																																																																																																																																																																																
Special	230	SY	Medium Strength Woven Polypropylene Fabric			230																																																																																																																																																																																																																																																																																																																																																																																																																																																																																																																																																																
203	768	CY	Granular Embankment #89 Stone			768																																																																																																																																																																																																																																																																																																																																																																																																																																																																																																																																																																
203	52	CY	Granular Embankment #304 Stone			52																																																																																																																																																																																																																																																																																																																																																																																																																																																																																																																																																																
511	4.70	CY	Class C Concrete, As per Plan			4.70																																																																																																																																																																																																																																																																																																																																																																																																																																																																																																																																																																
Special	Lump		Beam Seat Construction			Lump																																																																																																																																																																																																																																																																																																																																																																																																																																																																																																																																																																
517	50	Foot	Railing (Deep Beam Rail with Steel Tubular Backup and Type 2 Steel Post and Anchor Bolts)	50																																																																																																																																																																																																																																																																																																																																																																																																																																																																																																																																																																		
		<p>2 5</p> <p>18</p>										<p>ESTIMATED QUANTITIES & GENERAL NOTES</p> <p>DEF-TR68</p>																																																																																																																																																																																																																																																																																																																																																																																																																																																																																																																																																										

Figure 101. Illustration. Estimated quantities and general notes.

D.3 PROJECT PLAN AND PROFILE

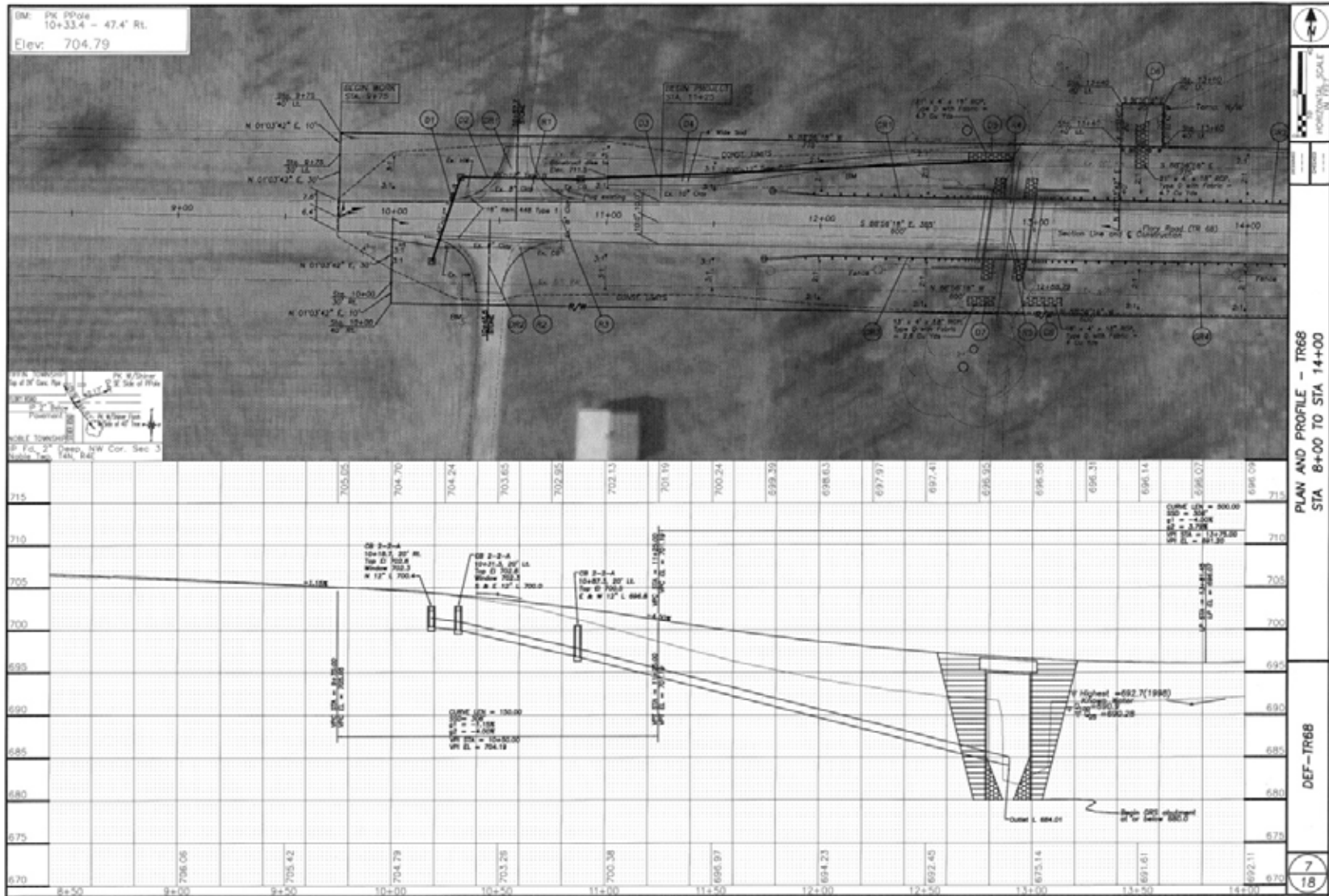

Figure 102. Illustration. Project plan and profile.

D.4 GRS ABUTMENT DETAILS

152

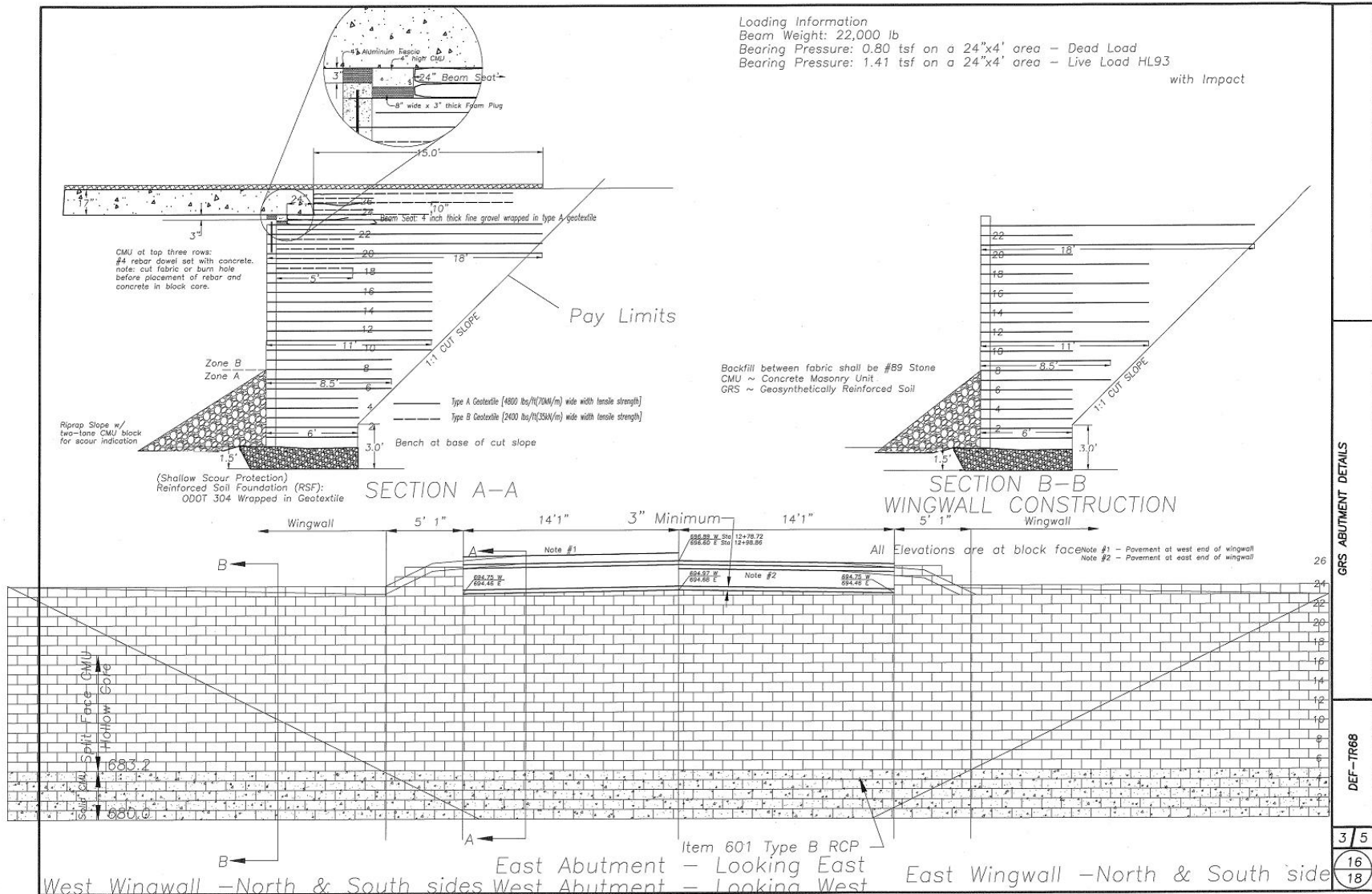

Figure 103. Illustration. Abutment details.

D.5 SITE PLAN

153

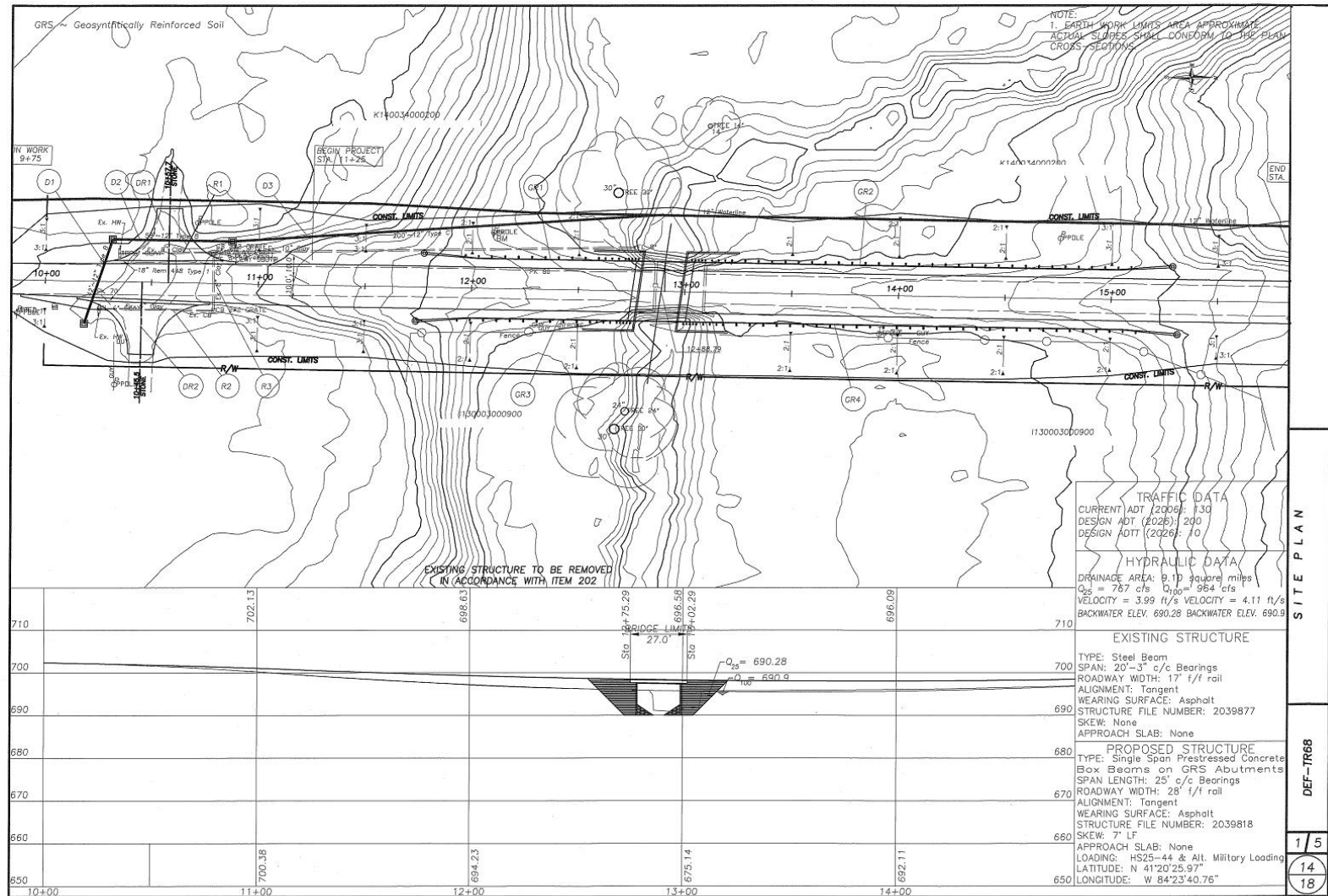

Figure 104. Illustration. Site plan.

ACKNOWLEDGEMENTS

The interim implementation manual and synthesis report have been reviewed by technical experts in various disciplines: geotechnical, structural, hydraulic, maintenance, and pavement engineering. The authors recognize the efforts and contributions of many members of the FHWA for this work, including Daniel Alzamora, Scott Anderson, Silas Nichols, Larry Arneson, Kornel Kerenyi, Joseph Krolak, Rich Barrows, Brian Collins, and Jorge Pagan.

The authors also recognize the contributions of other technical reviewers on this manual, including Jim Collin, Erik Loehr, Paul Macklin, Christopher Meehan, Al Ruckman, Naresh Samtani, and Calvin VanBuskirk.

REFERENCES

1. Adams, M.T., Nicks, J.E., Stabile, T., Wu, J.T.H., Schlatter, W., and Hartmann, J. (2010). *Geosynthetic Reinforced Soil Integrated Bridge System—Synthesis Report*, Report No. FHWA-HRT-11-027, Federal Highway Administration, McLean, VA.
2. Geo-Institute, Committee on Shallow Foundations. (1999). *Shallow Foundations on Reinforced Soil*, American Society of Civil Engineers, Reston, VA.
3. Adams, M.T. (2008). “The Bridge of Defiance County.” *Geosynthetics*, 26(2), pp. 14–16, 18, 20–21, Industrial Fabrics Association International.
4. Wu, J.T.H. (1994). *Design and Construction of Low Cost Retaining Walls: The Next Generation in Technology*, Report No. CTI-UCD-1-94, Colorado Transportation Institute, Denver, CO.
5. Lagasse, P.F., Clopper, P.E., Pagán-Ortiz, J.E., Zevenbergen, L.W., Arneson, L.A., Schall, J.D. and Girard, L.G. (2009). *Bridge Scour and Stream Instability Countermeasures, Volumes 1 and 2*, Third Edition. Hydraulic Engineering Circular No. 23, FHWA-NHI-HEC-23, Federal Highway Administration, Washington, DC.
6. AASHTO (2003). *Standard Practice for Conducting Geotechnical Subsurface Investigations*. American Association of State Highway and Transportation Officials, Washington, DC.
7. Samtani, N.C. and Nowatzki, E.A. (2006). *Soils and Foundations Reference Manual*. Report No. FHWA-NHI-06-088, National Highway Institute, Federal Highway Administration, Washington, DC.
8. Naval Facilities Engineering Command. (1982). *Soil Mechanics Design Manual 7.1*, Washington, DC.
9. AASHTO (2010). *LRFD Bridge Design Specifications*, Fifth Edition, American Association of State Highway and Transportation Officials, Washington, DC.
10. Berg, R., Christopher, B., and Samtani, N. (2009). *Design of Mechanically Stabilized Earth Walls and Reinforced Soil Slopes—Volume 1*, Report No. FHWA-NHI-10-024, National Highway Institute, Federal Highway Administration, Arlington, VA.
11. Wu, J.T.H., Pham, T.Q., and Adams, M.T. (2011). *Composite Behavior of Geosynthetic-Reinforced Soil (GRS) Mass*, Draft, Federal Highway Administration, McLean, VA.
12. Adams, M.T., Lillis, C.P., Wu, J.T.H., and Ketchart, K. (2002). “Vegas Mini Pier Experiment and Postulate of Zero Volume Change.” Proceedings, Seventh International Conference on Geosynthetics, pp. 389–394, Nice, France.

13. Wu, J.T.H., Lee, K.Z.Z., Helwany, S.B., and Ketchart, K. (2006). *Design and Construction Guidelines for GRS Bridge Abutment with a Flexible Facing*, Report No. 556, National Cooperative Highway Research Program, Washington, DC.
14. Richardson, E.V. and Davis, S.R. (2001). *Evaluating Scour at Bridges*, Fourth Edition, Hydraulic Engineering Circular No. 18, FHWA-NHI-01-001-HEC-18, Federal Highway Administration, Washington, DC.
15. Lagasse, P.F., Schall, J.D., and Richardson, E.V. (2001). *Stream Stability at Highway Structures*, Third Edition, Hydraulic Engineering Circular No. 20, FHWA-NHI-01-002-HEC-20, Federal Highway Administration, Washington, DC.
16. Sandri, D. (1997) "A Summary of Reinforced Soil Structure Performance in the Greater Los Angeles Area After the Northridge Earthquake." *Mechanically Stabilized Backfill*, pp. 433–442, J. Wu, ed., Balkema, Rotterdam, The Netherlands.
17. Tatsuoka, F., Koseki, J., Tateyama, M., Munaf, Y., and Horii, K. (1998) "Seismic Stability Against High Seismic Loads of Geosynthetic-Reinforced Soil Retaining Structures." Keynote Lecture, Proceedings, *6th International Conference on Geosynthetics*, pp. 103–142, Atlanta, GA.
18. Ling, H.I., Leshchinsky, D., and Chou, N.N.S. (2001) "Post-Earthquake Investigation on Several Geosynthetic-Reinforced Soil Retaining Walls and Slopes during 1999 Ji-Ji Earthquake of Taiwan." *Soil Dynamics Earthquake Engineering* 21(4), pp. 297–313.
19. Ling, H.I. (2003) "Chapter 25. A Critical Review of Full-Scale Shaking Table Tests Conducted on Reinforced Soil Retaining Walls." *Reinforced Soil Engineering: Advances in Research and Practice*, pp. 491–510, Marcel Dekker, New York, NY.
20. National Cooperative Highway Research Project 12-59(01). *Seismic Design of Geosynthetic-Reinforced Soil (GRS) Bridge Abutments with Flexible Facing*. Research in progress. Transportation Research Board, Washington, DC.
21. Occupational Safety and Health Administration (2010). "Sloping and Benching." *Safety and Health Regulations for Construction: Excavations.*, 29 CFR 1926, Subpart P App B, United States Department of Labor, Washington, DC. Accessed online: December 29, 2010 . (http://www.osha.gov/pls/oshaweb/owadisp.show_document?p_table=STANDARDS&p_id=10932).
22. Wu, J.T.H., Lee, K.Z.Z., and Pham, T. (2006). "Allowable Bearing Pressure of Bridge Sills on GRS Abutments with Flexible Facing." *Journal of Geotechnical and Geoenvironmental Engineering* 132(7), pp. 836–841, American Society of Civil Engineers.
23. Chan, C., Hover, K.C., Folliard, K.J., Hance, R.M. and Trejo, D. (2007). *Durability of Segmental Retaining Wall Blocks: Final Report*, Report No. FHWA-HRT-07-021, Federal Highway Administration, McLean, VA.

24. Juran, I., Guermazi, A., Chen, C.L. and Ider, M.H. (2005). "Modelling and Simulation of Load Transfer in Reinforced Poils: Part 1." *International Journal for Numerical and Analytical Methods in Geomechanics* 12(2), pp. 141–155, John Wiley and Sons, Hoboken, NJ.
25. Ketchart, K. and Wu, J.T.H. (2001). *Performance Test for Geosynthetic-Reinforced Soil Including Effects of Preloading*, Report No. FHWA-RD-01-018, Federal Highway Administration, McLean, VA.
26. Elton, D.J. and Patawaran, M.A.B. (2005). *Mechanically Stabilized Earth (MSE) Reinforcement Tensile Strength from Tests of Geotextile Reinforced Soil*, Alabama Highway Research Center, Auburn University, Auburn, AL.
27. Adams, M.T., Schlatter, W., and Stabile, T. (2007). "Geosynthetic-Reinforced Soil Integrated Abutments at the Bowman Road Bridge in Defiance County, Ohio." Proceedings, Geo-Denver 2007, American Society of Civil Engineers, Denver, CO.
28. Adams, M.T., Schlatter, W., and Stabile, T. (2007). "Geosynthetic-Reinforced Soil Integrated System." Proceedings, EuroGeo4, Paper No. 271, France.

