



RAILROAD COORDINATION MANUAL OF INSTRUCTION

**Utah Department of
Transportation**

July 2011

THIS PAGE INTENTIONALLY LEFT BLANK

TABLE OF CONTENTS

TABLE OF CONTENTS.....	i
ACRONYMNS AND ABBREVIATIONS.....	v
CHAPTER 1: INTRODUCTION.....	1
1.1. GENERAL.....	1
1.2. MANUAL ORGANIZATION.....	2
1.3. ROLES AND RESPONSIBILITIES.....	3
1.4. DEFINITIONS OF SELECTED TERMS USED IN THIS MANUAL.....	3
1.5. CURRENT LIST OF ACTIVE RAILROADS IN THE STATE OF UTAH.....	5
CHAPTER 2: LAWS, REGULATIONS, STANDARDS AND REFERENCES.....	6
2.1. FEDERAL LAWS, REGULATIONS, STANDARDS AND REFERENCES.....	6
2.2. STATE LAWS, REGULATIONS, STANDARDS AND REFERENCES.....	6
2.2.1. CODES AND RULES.....	6
2.2.2. UDOT STANDARD DRAWINGS, DOCUMENTS AND SPECIFICATIONS.....	7
2.3. RAILROAD STANDARDS AND REFERENCES.....	7
2.4. NATIONAL ASSOCIATION STANDARDS AND REFERENCES.....	8
2.5. CLEARANCES.....	8
2.5.1. AREMA CLEARANCES.....	9
2.5.2. MUTCD CLEARANCES.....	10
2.5.3. UDOT CLEARANCES.....	10
2.5.4. FHWA CROSSING SIGHT DISTANCES.....	10
CHAPTER 3: CROSSING PROJECT COORDINATION PROCESS.....	11
3.1. TYPES OF CROSSING PROJECTS.....	11
3.1.1. HIGHWAY IMPROVEMENT PROJECTS.....	11
3.1.2. GRADE SEPARATION PROJECTS.....	11
3.1.3. RAIL TRANSIT PROJECTS.....	11
3.1.4. CROSSING SAFETY IMPROVEMENT PROJECTS.....	11
3.1.5. DESIGN BUILD PROJECTS.....	12
3.2. GENERAL RAILROAD COORDINATION INFORMATION.....	13
3.2.1. DIAGNOSTIC TEAM.....	13
3.2.2. NEW CROSSINGS.....	14
3.2.3. GENERAL UTILITY GRADE CROSSING ENCROACHMENT PROCEDURES..	15

3.2.4.	CROSSING CLOSURES.....	15
3.2.5.	FUNDING AUTHORIZATION AND APPORTIONMENT OF COSTS.....	15
3.2.6.	PUBLIC NOTICE	16
3.2.7.	RAILROAD CROSSING INVENTORY	16
3.3.	PROJECT STAFF ORGANIZATION	17
3.3.1.	HIGHWAY IMPROVEMENT PROJECTS.....	17
3.3.2.	SAFETY IMPROVEMENT PROJECTS.....	17
3.4.	UDOT PROJECT DELIVERY NETWORK.....	17
3.4.1.	UDOT PROJECT DELIVERY NETWORK.....	17
3.5.	PROJECT AND COORDINATION TIMELINE	25
3.6.	CRITICAL ITEMS AND PROCESSES	28
3.6.1.	RIGHT-OF-WAY PROCESSES AND ACQUISITIONS	28
3.6.2.	RAILROAD FLAGGING.....	29
3.6.3.	FEDERAL REQUIREMENTS FOR RAILROAD COMPANY PARTICIPATION IN GRADE SEPARATION STRUCTURE COSTS	29
3.6.4.	ENVIRONMENTAL CONCERNS	30
CHAPTER 4:	RAILROAD AGREEMENTS	31
4.1.	RAILROAD AGREEMENTS	31
4.1.1.	SUMMARY OF UPRR MASTER AGREEMENT TERMS	32
4.1.2.	SUMMARY OF RAILROAD AGREEMENT TERMS.....	33
4.2.	HIGHWAY CROSSING DESIGN SUBMITTALS	37
4.3.	GRADE SEPARATED CROSSINGS.....	37
4.4.	RECEIVING AND REVIEWING RAILROAD PRICE PROPOSALS.....	37
4.4.1.	ANTICIPATED COSTS ASSOCIATED WITH CROSSING PROJECTS	37
4.5.	AGREEMENT IMPLEMENTATION	38
4.6.	SUPPLEMENTAL PROJECT AGREEMENTS	38
CHAPTER 5:	RAILROAD COORDINATION DURING CONSTRUCTION	39
5.1.	PRECONSTRUCTION CONFERENCE, NOTIFICATION TO RAILROAD.....	39
5.2.	CONTRACTOR RIGHT OF ENTRY	39
5.3.	INSURANCE REQUIREMENTS.....	40
5.4.	FLAGGING & PROTECTIVE SERVICES.....	40
5.5.	SAFETY TRAINING REQUIREMENTS.....	41

5.6.	MINIMUM SAFETY REQUIREMENTS FOR CONTRACTORS.....	42
5.6.1.	PERSONAL PROTECTIVE EQUIPMENT (PPE)	42
5.7.	CONSTRUCTION SUBMITTALS	43
5.8.	CONSTRUCTION FORMS.....	43
5.9.	RAILROAD RESPONSIBILITIES DURING CONSTRUCTION.....	43
5.10.	RAILROAD PERFORMED WORK.....	44
5.11.	UDOT RESIDENT ENGINEER RESPONSIBILITIES.....	44
CHAPTER 6:	PROJECT BILLING AND CLOSEOUT.....	45
CHAPTER 7:	UTILITY ENCROACHMENTS IN RAILROAD RIGHTS-OF-WAY	47
7.1.	UTAH TRANSIT AUTHORITY.....	47
7.2.	UNION PACIFIC RAILROAD COMPANY	49
CHAPTER 8:	MAINTENANCE COORDINATION	50
8.1.	EMERGENCY MANAGEMENT.....	51
APPENDIX	52
1.	FEDERAL DOCUMENTS	
1.1	23 USC 130	
1.2	23 USC 148	
1.3	23 CFR 140	
1.4	23 CFR 646	
1.5	23 CFR 655	
1.6	49 CFR 659	
1.7	FHWA Sight Distance	
1.8	MUTCD (2003) Gate Placement	
2.	STATE DOCUMENTS	
2.1	Utah Code 10-7-26	
2.2	Utah Code 10-7-27	
2.3	Utah Code 10-7-29	
2.4	Utah Code 41-6a-1205	
2.5	Utah Code 54-4-14	
2.6	Utah Code 54-4-15	
2.7	Utah Code Title 63G Chapter 3	
2.8	Utah Code 72-1-201	
2.9	R930-5	
2.10	UDOT Standard Drawing ST 7	
2.11	UDOT New Crossing Application	
2.12	UDOT Policy 08B-29	
2.13	UDOT Utility Memorandum 4-27-11	
2.14	UDOT Example Authorization for Preliminary Engineering Letter	

- 2.15 UDOT Example Surveillance Review Letter
- 2.16 UDOT C118 Form
- 2.17 UDOT C193 Form
- 2.18 UDOT C193A Form
- 2.19 UDOT Overhead Submittal Checklist
- 3. RAILROAD
 - 3.1 UPRR
 - 3.1.1 Standard Plan Sheet
 - 3.1.2 Encroachment Pipe form
 - 3.1.3 Flammable pipeline
 - 3.1.4 Gas line
 - 3.1.5 Non-flammable pipeline
 - 3.1.6 Parallel utility image
 - 3.1.7 Road crossing checklist
 - 3.1.8 RR survey permit
 - 3.2 UTA
 - 3.2.1 Cat I App
 - 3.2.2 Cat I Lic. Procedure
 - 3.2.3 Cat II App
 - 3.2.4 Cat. II Lic. Procedure
 - 3.2.5 Right of Entry Agreement Application
 - 3.3 Form B Flagging Requirements
 - 3.4 Railroad Cost Sharing Template
- 4. MAPS
 - 4.1 Railroad and Highway Location Maps

ACRONYMNS AND ABBREVIATIONS

AAR:	Association of American Railroads
AASHTO:	American Association of State Highway and Transportation Officials
AADT:	Average Annual Daily Traffic
AREMA:	American Railway Engineering and Maintenance-of-Way Association
CFR:	Code of Federal Regulations
DB:	Design Build
EIC:	Employee in Charge
FHWA:	Federal Highway Administration
FRA:	Federal Railroad Administration
HASP:	Health and Safety Plan
MUTCD:	Manual on Uniform Traffic Control Devices
NHTSA:	National Highway Traffic Safety Administration
PDBS:	Project Development Business System
PDN:	Project Delivery Network
PM:	Project Manager
PPE:	Personal Protective Equipment
RE:	UDOT Resident Engineer
RFP:	Request for Proposal
ROW:	Right-of-Way
STIP:	State Transportation Improvement Program
UCOFN:	Utility Contract Overrun Funding Need
UCRY:	Utah Central Railway
UDOT:	Utah Department of Transportation
UPRR:	Union Pacific Railroad
USDOT:	United States Department of Transportation
UTA:	Utah Transit Authority
UTAH:	Utah Railway

THIS PAGE INTENTIONALLY LEFT BLANK

CHAPTER 1: INTRODUCTION

1.1. GENERAL

UDOT projects vary widely in scope, complexity and purpose, with each project having its own set of unique issues and circumstances. In most cases however, there are processes that when followed will guide the project team through successful execution and close out of a project. Projects involving Railroads are no different. This Manual of Instruction (MOI) is intended to provide UDOT staff with background information on Railroad processes and suggest steps for successfully navigating Railroad related issues. Projects involving Railroads are unique because of the relationship of the various parties, UDOT's oversight responsibilities for Highway-Rail Crossings (Crossings) and process requirements of the Railroads.

UDOT has jurisdiction over all Crossings in the state of Utah that are traversed by the public. This authority is codified in Title 54 of the Utah State Code and Administrative Rule R930-5. Railroads, on the other hand, have jurisdiction over and are responsible for the safety of private crossings. UDOT's Crossing oversight goal is to improve the safety for all users and provide for the efficient operations of trains and vehicles and pedestrian access through Crossings. As part of this effort, UDOT promotes the elimination of Crossings, reviews all existing Crossings in the state for safety deficiencies, evaluates and approves the location of new Crossings, prescribes the type of improvements at Crossings and determines the maintenance responsibilities for Crossings.

Currently there are eight freight Railroads operating over 1,300 miles of track in the state of Utah. These freight Railroads carry over 20 million tons of freight on an annual basis. Additionally, UTA currently operates 80 miles of rail service along the Wasatch Front and the Salt Lake valley carrying tens of thousands of daily passenger trips. UTA will construct approximately 55 miles of additional passenger rail service by 2015. UTA's rail service includes light rail transit, commuter rail and the agency will soon begin the development of streetcar service. With the current and projected volumes of rail traffic, Railroad coordination will continue to be an important aspect of many UDOT projects. Successfully identifying, coordinating, and managing a project with Railroad related issues will be crucial to the success of projects statewide.

The purpose of this Manual is to provide:

- An overview of all processes, measures, and coordination efforts necessary to successfully carry out a Highway Project and/or Safety Improvement Project with Railroad components and considerations from project inception to close out.
- Identify critical path items and time-line completion requirements to minimize project delays and ensure a successful project delivery date.
- Establish best practices for all coordination, design and documentation activities on the project.

- Outline the roles and obligation of parties as defined in Utah State Code and define the roles and obligations of other UDOT personnel and stakeholders working on, or connected to a project.
- Outline federal, state and local laws, statues, roles and responsibilities.

It is not the intent of this MOI to be all-inclusive. Where this MOI uses the terms “include” or “including,” the implied meaning is “including but not limited to.” As discussed above, every project has its own set of unique circumstances and issues, so it is important on Railroad related projects to consult with appropriate UDOT staff including the UDOT Chief Railroad Engineer, UDOT Region Utility and UDOT Railroad Coordinator, or UDOT Statewide Region Utility and UDOT Railroad Coordinator at the earliest possible time in the project development phase to develop approaches to Railroad coordination issues.

1.2. MANUAL ORGANIZATION

Chapter 1: *Introduction*, introduces the Railroad Coordination Manual of Instruction. It describes the Manuals purpose, organization, and outlines Manual definitions and acronyms.

Chapter 2: *Laws, Regulations, Standards and References*, outlines federal, state, railroad and national association standards used or referenced in this Manual.

Chapter 3: *Railroad Coordination Process*, provides guidance for UDOT personnel for project development and documentation tasks.

Chapter 4: *Railroad Agreements*, describes the many types and components of railroad agreements.

Chapter 5: *Railroad Coordination During Construction*, outlines the roles and responsibilities associated with project construction oversight and documentation.

Chapter 6: *Project Billing and Closeout*, provides guidance to the invoicing, billing and payment aspects of a typical project. Includes direction and information of final closeout of the project.

Chapter 7: *Utility Encroachments in Railroad Rights-of-Way*, outlines current Railroad policy pertaining to utility encroachments.

Chapter 8: *Maintenance Coordination*, outlines the roles and responsibilities of the Highway Authority and the Railroad after the crossing has been constructed.

Appendix: Includes many of the standard forms and information required to execute a highway-rail project.

1.3. ROLES AND RESPONSIBILITIES

This section describes the roles and responsibilities for the various parties involved in Railroad related Safety Improvement Projects and Highway Improvement Projects that have a Railroad component. The descriptions are meant to provide the general functions of the positions and do not include an exhaustive detail of all responsibilities.

“Railroad Project Manager”: This title varies by Railroad but for purposes of this manual this position is the point of contact for a specific Railroad.

“UDOT Region Utility and UDOT Railroad Coordinator”: UDOT Region Coordinator is responsible for coordinating with the Railroads and developing all utility and Railroad agreements necessary to successfully complete projects within their respective Regions, including overseeing the design and coordination efforts of consultants as defined in the most current version of the UDOT Project Delivery Network.

“UDOT Statewide Utility Engineer”: Manages the Utility and Railroad Coordination Program at the Central Project Development level. Serves as the program resource for the Regions, serves as UDOT’s Management Liaison with Railroad Companies, participates in the resolution of issues escalated from the project or region level.

“UDOT Chief Railroad Engineer”: This Traffic and Safety Division position is charged with regulating and promoting safety at all locations in the state where public roads cross Railroad tracks. This includes state highways, county roads, city streets, and all other public accesses across rail lines.

“UDOT Project Manager”: This position oversees the delivery of the project from concept/environmental phases, through design phase, to the construction delivery phase. The UDOT Project Manager provides continuity of project knowledge and history throughout all phases.

1.4. DEFINITIONS OF SELECTED TERMS USED IN THIS MANUAL

The section provides definitions used in the Manual of Instruction. The definitions are consistent with those used in the Utah State Administrative Rule R930-5 that outlines UDOT’s jurisdictional authority over Highway-Rail Grade Crossings.

Administrative Rule R930-5 “The Rule” means the administrative rule that establishes and grants UDOT the authority to regulate Highway-Rail Grade Crossings.

“Company” means any local district or utility company.

"Highway" means any public road, street, alley, lane, court, place, viaduct, tunnel, bridge, or structure laid out or erected for public use, or dedicated or abandoned to the public, or made public in an action for the partition of real property, including the area within the ROW.

"Highway Authority" means UDOT or local governmental entity that owns or has jurisdiction over a highway.

"Highway Improvement Project" Projects on highways that cross railroad properties or involve adjustments to railroad facilities to accommodate highway construction that may or may not involve the elimination of hazards at a crossing.

"Highway-Rail Grade Crossing" (*"Crossing"*) means the general area where a Highway and a Railroad cross at the same level within which are included the rail line, Highway, and roadside facilities for public traffic traversing the area.

"Neutral Quadrant" means the quadrant that minimizes sight distance conflicts with immediate on-coming auto traffic. Generally, the neutral quadrant is on the far side of the tracks from the direction of vehicular travel.

"New Crossing Application" is a UDOT application that a Highway Authority, Railroad or Company must submit when requesting a new Crossing.

"MOI" means this UDOT Railroad coordination Manual of Instruction

"Preliminary Engineering (PE) Letter" means a letter issued by UDOT authorizing a Railroad to commence design on Railroad related improvements.

"Railroad" means all rail carriers, whether publicly or privately owned, and common carriers, including line haul freight and passenger Railroads, public transit districts, switching and terminal Railroads, passenger carrying Railroads such as rapid transit, and commuter and street Railroads.

"Safety Improvement Project" means a project that eliminates hazards and improves the safe operation of trains, vehicles, and pedestrians through a crossing and is authorized and funded by United States Code, Title 23, Federal Safety Program funds.

"Surveillance Review" means the final order issued by the Chief Railroad Engineer outlining the improvements of a Crossing.

"USDOT#" Means a unique numerical identifier to a Crossing that contains six digits followed by an alpha check character (example: 123-456X), it is sometimes referred to as DOT#.

1.5. CURRENT LIST OF ACTIVE RAILROADS IN THE STATE OF UTAH

Railroad Type and Company	Miles of Operated Track	UDOT Region
*Class I Railroads:		
BNSF Railway Company	434	2, 3
Union Pacific Railroad Co.	1,261	1, 2, 3, 4
*Regional Railroads:		
Utah Railway Co.	293	2, 3, 4
*Switching & Terminal Railroads:		
Salt Lake City Southern Railroad	5	4
Savage Bingham & Garfield	7	2
Utah Central Railway Co.	34	1
*Local Railroads:		
Salt Lake, Garfield & Western Railway	12	2
Heber Valley Railroad	17	3
**Transit/Passenger Rail:		
Amtrak	191	2, 3, 4
UTA TRAX Light Rail	36/45	2
UTA FrontRunner Commuter Rail	45/89	1, 2, 3
<i>UTA Sugar House Streetcar</i>	2	2

**Information based on 2008 data from Association of American Railroads.*

***Information based on 2010 data from UTA.*

CHAPTER 2: LAWS, REGULATIONS, STANDARDS AND REFERENCES

2.1. FEDERAL LAWS, REGULATIONS, STANDARDS AND REFERENCES

[23 USC Section 130](#) “Railway-highway crossings” ([Appendix 1.1](#))

[23 USC Section 148](#) “Highway safety improvement program” ([Appendix 1.2](#))

[23 CFR 140](#) “Reimbursement” ([Appendix 1.3](#))

[23 CFR 646](#) “Railroads” ([Appendix 1.4](#))

[23 CFR 655](#) “Traffic Operations” ([Appendix 1.5](#))

[49 CFR 659](#) “Rail fixed guideway systems; State safety oversight” ([Appendix 1.6](#))

[FHWA Railroad Highway Grade Crossing Handbook](#)

[Federal Railroad Administration \(FRA\)](#)

[Federal Transit Administration \(FTA\)](#)

2.2. STATE LAWS, REGULATIONS, STANDARDS AND REFERENCES

2.2.1. CODES AND RULES

[Utah Code Title 10 Chapter 7 Section 26](#) “Streets and alleys used by railway companies” ([Appendix 2.1](#))

[Utah Code Title 10 Chapter 7 Section 27](#) “Street railway companies to restore streets” ([Appendix 2.2](#))

[Utah Code Title 10 Chapter 7 Section 29](#) “Railway companies to repave streets” ([Appendix 2.3](#))

[Utah Code Title 41 Chapter 6a Section 1205](#) “Railroad grade crossings – Certain vehicles must stop – Exceptions – Rules.” ([Appendix 2.4](#))

[Utah Code Title 54 Chapter 4 Section 14](#) “Safety regulation” ([Appendix 2.5](#))

[Utah Code Title 54 Chapter 4 Section 15](#) “Establishment and regulation of grade crossings.” ([Appendix 2.6](#))

[Utah Code Title 63G Chapter 3](#) “The Utah Administrative Rulemaking Act” ([Appendix 2.7](#))

[Utah Code Title 72 Chapter 1 Section 201](#) “Creation of Department of Transportation – Functions, powers, duties, rights, and responsibilities.” ([Appendix 2.8](#))

[Utah Administrative Rule R930-5 \(Appendix 2.9\)](#)

2.2.2. UDOT STANDARD DRAWINGS, DOCUMENTS AND SPECIFICATIONS

[2008 UDOT Standard Drawings](#)

"Standard Drawing ST 7 Pavement Marking and Signs at Railroad Crossings", Utah Department of Transportation (UDOT) ([Appendix 2.10](#))

[UDOT New Crossing Application \(Appendix 2.11\)](#)

UDOT Policy 08B-29, "Accomplishment of and Payment for Utility Relocations Required in Connection with Highway Work" (Including Railroad Relocation) ([Appendix 2.12](#))

[UDOT Standard Specifications](#)

[UDOT Supplemental Specifications](#)

[UDOT Special Provisions](#)

UDOT Statewide Utility Memorandum 04-27-2011 ([Appendix 2.13](#))

2.3. RAILROAD STANDARDS AND REFERENCES

GCOR [General Code of Operating Rules](#)

UPRR-BNSF [Guidelines for Grade Separation Projects](#)

UPRR [At-Grade Crossing Guidelines](#)

UPRR [Industrial Track Specifications](#)

UPRR [Structure Demolitions Guidelines](#)

UPRR [Guidelines Temporary Shoring](#)

UPRR [Construction Requirements](#)

UPRR [Interim Specification for Directional Bore Method](#)

UPRR [Insurance Requirements for Right of Entry](#)

UTA [Commuter Rail Design Criteria](#)

UTA [Light Rail Design Criteria](#)

2.4. NATIONAL ASSOCIATION STANDARDS AND REFERENCES

"A Policy on Geometric Design of Highway and Streets", American Association of State Highway and Transportation Officials (AASHTO) (2004);

"Preemption of Traffic Signals Near Railroad Crossings", Institute of Traffic Engineers (ITE) (2004); and

"Manual for Railway Engineering", American Railway Engineering and Maintenance-of-Way Association (AREMA), 2007.

2.5. CLEARANCES

The clearances noted in this section are general clearances provided for informational purposes only. When developing design details, additional review should be given to the appropriate federal, state, Railroad and industry standards to ensure proper clearances are maintained.

Clearances should be reviewed by project designers and project managers during the plan sheet development stages. They should be reviewed for overall geometry, active warning device placement, signing, striping, and overall conformance to standards.

The UDOT Project Manager should review all offsets and clearances of plans during plan review periods. The UDOT Chief Railroad Engineer should also review plans during plan review periods to ensure all clearances, offsets and control systems have been accounted for and achieved.

The order of precedence for the design and review of Crossings is as follows:

Order of Precedence for Highway-Rail Crossing Design Standards		
Rank	Traffic Control Systems	Track/Crossing Design
1	MUTCD	FHWA
2	UDOT	AASHTO
3	RR Standards	AREMA
4		RR Standards

2.5.1. AREMA CLEARANCES

AREMA Clearances for the State of Utah				
Regulation Reference: G.O. 66 08-31-53				
Track Centers	Main Tracks		14'-0"	
	Any Two Subsidiary Tracks		14'-0"	
	Adjacent Subsidiary Track to Any Main Track		15'-0"	
	Ladder Track Adjacent to Any Parallel Track		17'-0"	
	Two Adjacent Parallel Ladder Tracks		18'-0"	
	Lead, Repair and Caboose Tracks		14'-0"	
	Team Tracks in Pairs		11'-6"	
	Unloading Tracks at Platforms		11'-6"	
Vertical	General		22'-6"	
	Thru Bridges		22'-6"	
	Highway Bridges		23'-0"	
	Tunnels		22'-6"	
	Building Doors		18'-0"	
	In Buildings		18'-0"	
Horizontal	General		8'-6"	
	Thru Bridges		8'-0"	
	Highway Bridges		8'-6"	
	Tunnels		8'-0"	
	Building Doors		8'-6"	
	In Buildings		8'-6"	
	Platforms	A		0'-8"
		B		4'-8"
		C		1'-9"
		D		5'-8"
		E		4'-0"
		F		7'-3"
	Signals	Low, Betwe en Tracks	High	8'-6"
			Height	3'-0"
	Switch Boxes, Etc.	Clearance	Height	6'-0"
			Height	0'-4"
	Poles	Clearance	3'-0"	
		Poles	8'-6"	
		Mail Cranes	E	
		Icing Docks	7'-8"	
		Ore and Coal Docks	8'-6"	
		Cattle Chutes	8'-6"	
Pipelines	22'-6"			

2.5.2. MUTCD CLEARANCES

The MUTCD provides clearances for traffic control systems at highway-rail crossings. The systems identified within the MUTCD include signs, pavement markings, and signals. Refer to the UDOT adopted version of the MUTCD for further guidance on crossing traffic control system type and placement. Refer to the Appendix, Section 1 for more specific signal and sign post offset illustrations.

2.5.3. UDOT CLEARANCES

The UDOT Standard Drawing ST 7 provides guidance on the placement of highway-rail crossing signage and pavement markings and should be the basis for all traffic control systems for all crossings in the state of Utah. For items not identified by ST 7, reference should be given to the other design standards noted in this section. Below is a sketch of the adopted UDOT Signal House Placement from the MUTCD:

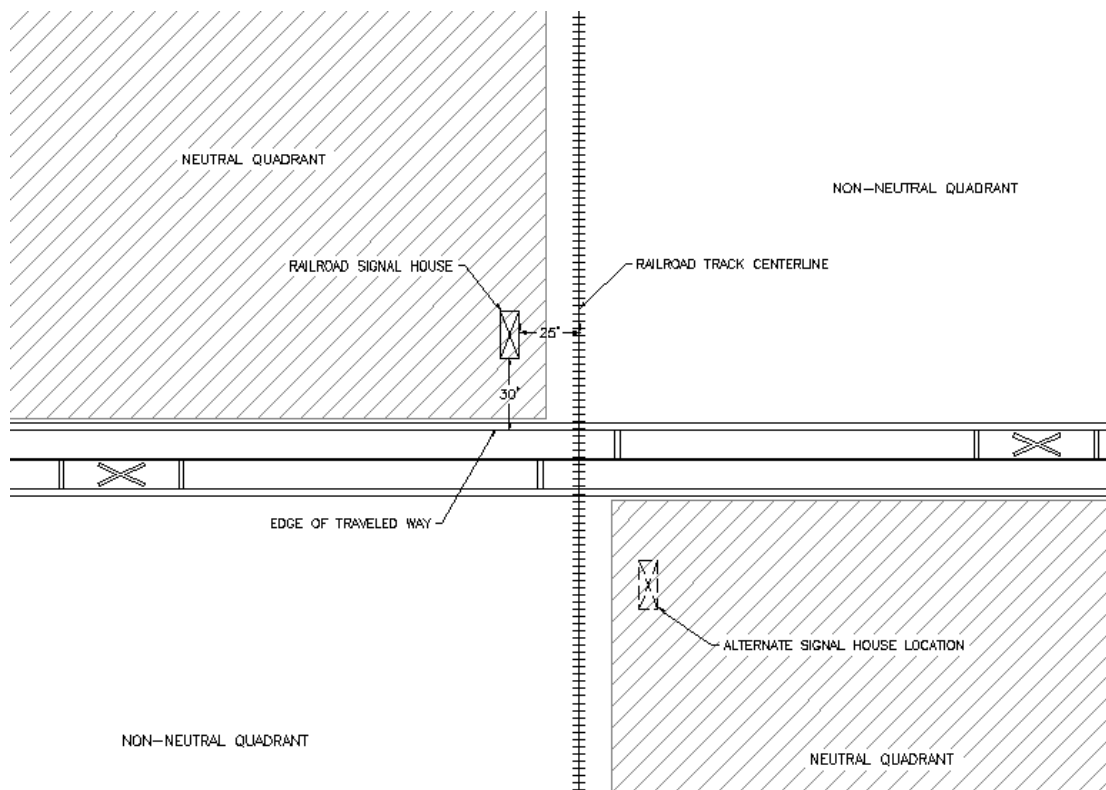

Neutral Quadrant locations as shown are the locations in which the Railroad signal houses or “bungalow’s” and facilities are to be placed in order to ensure driver sight distance of the rail corridor is not impaired.

2.5.4. FHWA CROSSING SIGHT DISTANCES

The proximity of obstructions to a crossing is of great concern and importance to the overall safety of a crossing. The ability of the driver to see an approaching train shall not be obstructed. Refer to the FHWA Railroad-Highway Grade Crossing Handbook for sight distance requirements and guidance. See [Appendix Section 1.7](#).

CHAPTER 3: CROSSING PROJECT COORDINATION PROCESS

3.1. TYPES OF CROSSING PROJECTS

For purposes of this MOI, projects have been categorized under two general project types; Highway Improvement Projects and Safety Improvement Projects.

3.1.1. HIGHWAY IMPROVEMENT PROJECTS

- Highway Improvement Projects include, but are not limited to:
 - Crossing Projects that use Railroad properties or involve adjustments to Railroad facilities required by Highway construction, but do not involve the elimination of hazards at a crossing.
 - Construction of a new Crossing at or over a Railroad track where the new Highway is not a relocation of an existing Highway.
- Highway Improvement Projects will be evaluated and selected as part of UDOT's normal STIP evaluation and approval process.

Highway projects impacting existing or creating new Crossings are identified and selected as part of UDOT's planning, programming, STIP evaluation and project approval process.

3.1.2. GRADE SEPARATION PROJECTS

Grade Separation Projects include, but are not limited to:

- Construction of new highways requiring new grade separation structures.
- Construction of new grade separation structures that eliminate existing Crossings.
- Reconstruction of existing grade separation structures.

3.1.3. RAIL TRANSIT PROJECTS

Rail Transit Projects include, but are not limited to:

- The Coordination required to facilitate the design and construction of Light Rail, Streetcar and Commuter Rail facilities within or crossing state highways, either at-grade or grade separated.

3.1.4. CROSSING SAFETY IMPROVEMENT PROJECTS

Crossing Safety Improvement Projects are identified and delivered by UDOT's Traffic and Safety Division in cooperation with local governments and Railroads.

Crossing Safety Improvement Projects include, but are not limited to:

- Elimination of a Crossing by combining multiple crossings.
- Elimination of a Crossing by the relocation of a highway.

- Elimination of a Crossing by the construction of a new grade separation.
- New safety improvements.
- Reconstruction of a Crossing grade separation structure.
- Repair of a Crossing material, that would otherwise be the responsibility of the Railroad as prescribed in the R930-5, if the repair of the Crossing material affects or is an integral part of the crossing safety devices.

UDOT has established a process for the evaluation and selection of Crossing Safety Improvement Projects that considers the potential reduction in the number and/or severity of collisions, the cost of the crossing projects, and available resources. Specific methods for selecting and prioritizing crossing for improvements include:

- The collection and maintenance of data utilizing the USDOT Grade Crossing Inventory to record crossing data including, but not limited to the current physical condition, average daily traffic, and collision data associated with a crossing.
- An engineering study conducted on a crossing at the request of a Highway Authority, Railroad, or company or using a priority list developed using the USDOT Accident Prediction Model. The purpose of the engineering study is to review the crossing and its environment, identify the nature of any deficiencies and recommend alternative improvements. Specifically, an engineering study reviews crossing characteristics, the existing traffic control system, and the highway and Railroad characteristics. Based on the review of these conditions, an assessment of the existing and potential hazards is made, deficiencies are identified and countermeasures are recommended.

System or corridor evaluations consider a crossing as a component of a larger transportation system. The objective is to improve both safety and operations of the total system or segments of the system. In such cases, all crossings within a corridor are evaluated and can be programmed for improvements. The optimal outcome of a corridor study involves a combination of engineering improvements and closures such that both safety and operations are highly improved.

3.1.5. DESIGN BUILD PROJECTS

Design Build (DB) projects present a unique set of complexities given the number of, and differing responsibility of the parties involved. The DB team is responsible for design of grade separation structures or Crossing installations or reconstructions. UDOT should initiate early coordination efforts with the Railroad, well in advance of the RFP being prepared and before the DB Contractor is selected. The Project Manager, through the Region Utility and Railroad Coordinator, should request a Surveillance Review of the impacted Crossings, and the recommendations of the review should be incorporated into the RFP as contract requirements. For grade separation structure construction or reconstruction, UDOT should discuss track configuration, future track requirements, off track maintenance access and other issues that will dictate the span of the structure prior to the issuance of the RFP. Temporary Crossings

and any other required Railroad work that can be identified early on should be discussed and commenced as early as possible in the RFP Phase so they don't delay projects. Effective communication is needed between the UDOT Project Manager, Project or Region Utility and Railroad Coordinators, Railroad and DB Team. Timely completion and review of structure and crossing designs, and the early execution of the Railroad agreements will ensure the DB project remains on schedule.

3.2. GENERAL RAILROAD COORDINATION INFORMATION

The Rule describes the procedures for evaluating and selecting a Crossing for improvement as well as for evaluating and selecting the type of improvements at a Crossing, including passive and active warning devices, and for evaluating and determining whether a Crossing should be grade separated. The Rule also outlines the roles and responsibilities of the various parties with respect to the design, maintenance and funding for Crossing Improvements. In short, the Rule establishes the ground rules for the Railroad coordination process.

In the sections that follow, the critical components and processes established in the Rule have been incorporated to provide a quick reference for the UDOT Project Manager or designee. It is recommended that all parties review and understand the Rule.

3.2.1. DIAGNOSTIC TEAM

A critical component of the Railroad coordination process is the Diagnostic Team, which is lead by the UDOT Chief Railroad Engineer. The UDOT Project Manager, through the Region Utility and Railroad Engineer, should contact the UDOT Chief Railroad Engineer at the earliest possible time to schedule a Diagnostic Team review if their Highway Improvement Project affects a Crossing.

The role of the Diagnostic Team is to make recommendations to UDOT for required safety improvements at existing and proposed Crossings and to evaluate, make recommendations and approve the design of modifications to existing Crossing facilities necessitated by highway construction projects.

The Diagnostic Team is usually composed of the following team members:

- UDOT Chief Railroad Engineer
- Representative from the Railroad
- Representative from the appropriate Private Company, if applicable
- Representative from the Local Highway Authority (preferably from engineering or public works), as applicable on Local Government Projects, and where appropriate, representatives of the public school district, law enforcement agency and others with an interest in the Crossing
- The Region Utility and Railroad Coordinator and the Project Design Team for Highway Improvement Projects

Specific responsibilities of the Diagnostic Team include:

- Recommend the elimination of a Crossing
- Recommend the type of safety improvements including, but not limited to passive and active warning devices, the type of Crossing material, improvements to Highway approaches, removal of foliage and brush, pedestrian facilities (including compliance with ADA requirements), and improvements to street lighting
- Review all requests for a new Crossing
- Review all requests to reclassify a Crossing from private to public
- Recommend that UDOT conduct an engineering study to evaluate the need for a new overpass or other grade separation structure(s)
- Recommend any other safety related changes to improve vehicle and pedestrian safety

Design restrictions for modified Crossings and adjacent accesses

- No new access openings can be opened within 250' of a Crossing unless approved by the UDOT Chief Railroad Engineer.
- Prior to approving new residential, commercial, or industrial development within 1000 feet of a Crossing, the Highway Authority shall request a Diagnostic Team review to assess the potential traffic impacts at the Crossing.

Before a Highway Authority approves increased development that changes the conditions of a Crossing by significantly increasing traffic volumes, the Highway Authority plans shall be approved by the Chief Railroad Engineer.

3.2.2. NEW CROSSINGS

UDOT supports FRA's Risk Reduction Program to improve the safety of the nation's rail network and acknowledges that reducing the number of Crossings is an important component of that effort. It is unrealistic however, to expect there will not be a demonstrable need for a new Crossing in certain circumstances. With the goal of reducing the number of Crossings under the FRA Risk Reduction Program, UDOT's initial requirement for any request to open a new Crossing will be to close two Crossings within the same jurisdiction. If it is determined by UDOT that two other crossings cannot be closed, significant safety improvements must be made to other crossings on the corridor to show an overall safety improvement.

When a Highway Authority widens or constructs a new Highway, the Highway Authority shall be responsible to request a Diagnostic Team review of the Crossing and arrange by agreement with the Railroad to design and install all required improvements concurrent with its request for approval from UDOT.

A completed copy of the [New Crossing Application](#) form published by UDOT shall also be submitted to the UDOT Chief Railroad Engineer by the Highway Authority, Railroad, or Company

making the request prior to the Diagnostic Team review. The following information must be submitted as part of a New Crossing Application:

- A Highway Authority, Railroad, or Company making a request for a new Crossing or the reclassification of a Crossing from private to public shall provide UDOT with an approved master street plan from the appropriate jurisdiction showing the elimination or combination of existing Crossings and/or other safety improvements that enhance the overall safety of the corridor before a new Crossing or reclassification of a Crossing from private to public will be approved.
- A Highway Authority, Railroad, or Company requesting a new Crossing or reclassification of a Crossing from private to public will mutually arrange by agreement for the proposed new Crossing or reclassification of a Crossing before the UDOT Chief Railroad Engineer will approve of the change.

3.2.3. GENERAL UTILITY GRADE CROSSING ENCROACHMENT PROCEDURES

In the state of Utah, UTA and Union Pacific Railroad are identified with the largest majority of Railroad utility encroachments. Each Railroad has specific processes, procedures and regulations for obtaining encroachment licenses and/or permits. Chapter 7: *Utility Encroachments in Railroad Rights-of-Way*, provides the information necessary to identify varying types of encroachments, and each Railroad's policies and procedures.

3.2.4. CROSSING CLOSURES

Crossings can be closed for several reasons including Crossing consolidations and for safety reasons. UDOT has the authority to temporarily close a Crossing if the UDOT Chief Railroad Engineer makes a determination that the Crossing poses an undue risk to the public. As mentioned above, UDOT supports the closing of Crossings. UDOT also recognizes that permanently closing a Crossing can have a significant impact on surrounding communities by altering traffic patterns. So any decision to permanently close a Crossing will involve an analysis of the impacts to be conducted by the requesting Local Highway Authority, Railroad or Private Company and a public outreach effort that is overseen by UDOT, see Section 3.2.6 for further details. As with all actions affecting a Crossing, closures shall also be reviewed by a Diagnostic Team.

3.2.5. FUNDING AUTHORIZATION AND APPORTIONMENT OF COSTS

FHWA approved Safety Improvement Projects are eligible for federal safety funding. As stated previously, if a Region is interested in determining the eligibility of its project for safety funding, please contact the UDOT Chief Railroad Engineer at the earliest possible time. Below is a list of criteria for determining funding eligibility and apportionment of costs:

- Generally, costs must be associated with a FHWA authorized and approved Safety Improvement program to be eligible for federal participation. Eligible costs incurred in an approved program prior to authorization by FHWA are not reimbursable, but may be included as part of the Railroad's share of the project cost where such a share is required. Eligible costs include, but are not limited to cost associated with environmental clearance, preliminary engineering, and ROW acquisition.
- Apportionment of costs for installation, maintenance, and reconstruction of safety related improvements at a Crossing shall be in accordance with 23 CFR 646 and Section 54-4-15.
- When a Highway Authority widens a Highway, the Highway Authority shall fund all improvements including, but not limited to passive and active warning devices, Crossing material, and other improvements as ordered by the UDOT Chief Railroad Engineer in consultation with the Diagnostic Team.

UDOT will evaluate each Crossing project to determine the extent to which, if any, the Crossing projects benefits the respective parties. If a Crossing project is determined not to benefit a party, the party will not be required to participate in the funding.

3.2.6. PUBLIC NOTICE

Certain Crossing improvements and actions require a public notice and opportunity for a public hearing. These improvements and actions include:

- When UDOT is considering a proposal to close a Crossing, add a track at a Crossing, or construct a new Crossing. It is the responsibility of the Highway Authority, Railroad, or Company requesting the proposed action, in consultation with the UDOT Chief Railroad Engineer, to carry out the requirements of this section unless otherwise agreed to by the UDOT.

In instances where the action proposed by the UDOT does not substantially affect the public, UDOT may waive the requirement to notice a public hearing opportunity, provided the affected Diagnostic Team members concur in writing.

3.2.7. RAILROAD CROSSING INVENTORY

The Federal Railroad Administration currently oversees the management of the USDOT crossing inventory. The inventory consists of all Crossings in the nation, private, public, both at-grade and grade separated. Each crossing is assigned a USDOT#. Each USDOT# is unique to every crossing with no two being the same. For each crossing a USDOT crossing inventory form is maintained. The inventory form identifies location of the crossing, operating Railroad(s), physical characteristics, train movement information, crossing protection and highway information. Each state is responsible to maintain all crossing inventories which involve inspection, documentation, and updating the national database on an annual basis. Railroads contribute selected information for the inventory and may directly submit to the FRA. FRA acts solely as the "maintainer" of inventories.

3.3. PROJECT STAFF ORGANIZATION

3.3.1. HIGHWAY IMPROVEMENT PROJECTS

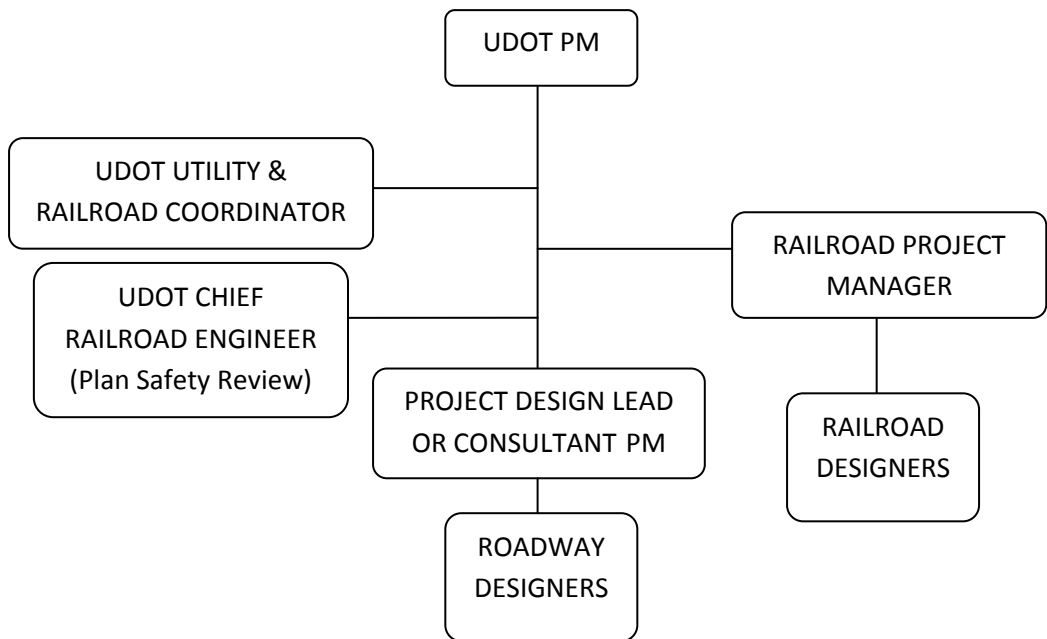

3.3.2. SAFETY IMPROVEMENT PROJECTS

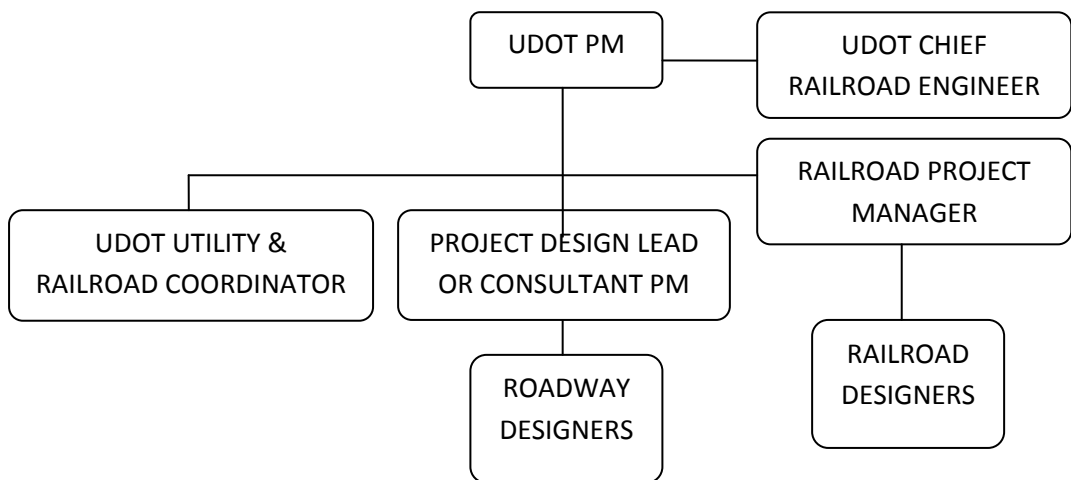

3.4. UDOT PROJECT DELIVERY NETWORK

3.4.1. UDOT PROJECT DELIVERY NETWORK

Railroad related tasks fall under the utility discipline of the Project Delivery Network (PDN). For easy reference, Railroad tasks have been listed below with a brief narrative (if applicable) regarding the timing of the tasks, nuanced aspects of tasks and critical items that must be accomplished to maintain overall project timelines. Review should also be given to the full version of the PDN to ensure all items have been accounted for and addressed.

General

2U1 Utility & Railroad Identification

- Identify Utility and Railroad within project limits
 - Identify all utility and Railroad within the project limits (See Railroad & Highway Location Maps [Appendix 4.1](#))
 - Identify point of contact for each Railroad for project design coordination
 - Develop a Utility and Railroad contacts list, which includes each contact's name, phone number, address, and email

Identifying the actual Railroad that has review and approval rights can be complicated especially in the urban areas. Within a Railroad ROW, more than one Railroad can have ownership, with each Railroad having review and approval rights. In certain ROW, one Railroad may own the land in fee title, but another Railroad may have operating rights and the right to review and approve of any changes to Crossings.

- Notify Railroads of project and request utility records/plans – contact each utility and Railroad within the project limits. Provide each with the following:
 - Project area and description
 - Request the records and plans of their facilities within the project limits
 - Invitation to scoping meeting at least 30 day prior to the meeting
- Obtain Surveillance Review (For Crossings projects only)
 - The Diagnostic Team decides and formalizes track configuration commitments for grade separation structures. The UDOT Region Utility and Railroad Coordinator contacts UDOT Chief Railroad Engineer to initiate Surveillance Review.
 - The UDOT Chief Railroad Engineer provides the Surveillance Review. Refer to rule R930-5: Establishment and Regulation of At-Grade Railroad Crossings.
 - Provide the Railroad 30 days notice prior to Surveillance Review.
 - Notify the Railroad of the impending construction and request their updated facility plans. Provide a project area map and description.
 - Develop a Railroad reviews plan.
 - The UDOT Chief Railroad Engineer uses Form R-709 to request federal safety funding for eligible Crossings.

The Surveillance Review outlines the improvements required at a Crossing ([Appendix 2.15](#)). Design cannot begin on the Crossing safety improvements until the UDOT Chief Railroad Engineer has issued a final order outlining the improvements, so it is important to initiate this process at the earliest possible time in the project delivery process. Surveillance Reviews should also be conducted on projects that do not directly impact a Crossing but will alter its current use or safety, i.e. residential development, roadway and/or driveway proximity, etc... The timing and initiator of the R-709 submission is dependent on the type of project. For Safety Improvement Projects the UDOT Chief Railroad Engineer typically initiates the R-709, for

Highway Improvement Projects the UDOT Project Manager initiates the R-709. For combined projects the UDOT Project Manager and UDOT Chief Railroad Engineer, or designees will both initiate R-709s.

At-Grade Crossings

3U4 Complete Utility and Railroad Designs

- Develop Crossing design
 - Develop the proposed at Crossing including, but not limited to, the following:
 - Warning Device design
 - Grading
 - Pavement section
 - Lane transitions
 - Cut/fill lines
 - Identify additional ROW impacts
 - Identify additional utility impacts
 - Maintenance Access
 - Fences
 - Pedestrian Access
 - Raised Islands
 - Removals
 - Trails
 - Preliminary Signing
 - Evaluate clear zone hazards and appropriate protection devices.
 - Conform to Railroad standards
 - Conform to UDOT standards
 - Roadway Manual of Instruction
 - UDOT standard and supplemental drawings
 - Calculate quantities
- Prepare Crossing plan sheets – follow current Railroad requirements and standards and UDOT CADD Standards and UDOT Plan Sheet Development Standards to create Crossing plan sheets.
 - Create all necessary sheets for a Railroad review
 - Label all important design features
 - Include utility, ROW, and drainage information
 - Include all Railroad required information
- Develop utility relocation/ Crossing cost estimate
 - Compile Crossing bid items and quantities
 - Use UDOT standard bid items
 - Develop unit costs for each item
 - Use appropriate resources for developing unit costs (PDBS, local contractors, etc.)

- Document unit cost development, assumptions, etc...
- Account for project specific factors (see below)
- Use lump sum pricing only when appropriate
 - Consider contractor risk due to unknown quantity
 - Consider difficulty in pricing per unit
 - Consider all materials and labor involved
- Submit Crossing sheets and forms for Railroad review – follow the current Railroad requirements to complete and submit all required forms.
 - Prepare all forms and documents the Railroad requires for review
 - Submit review plans and forms to the UDOT Chief Railroad Engineer
 - Submit plans and forms to the Railroad for review and comments
 - Request the preliminary surface and signal cost estimate from Railroad for their facility modifications

Once a Railroad has received the PE Letter, it will prepare the signal and track designs for all Safety and Highway Improvement Projects, see [Appendix 2.14](#) for an example PE Letter.

4U1 Prepare and Obtain Utility and Railroad Agreements and Permits

- Complete Railroad construction and maintenance agreement
 - Upon receipt of a cost estimate or instruction from the Railroad, the UDOT Project Railroad Coordinator incorporates the correct information and language into the construction and maintenance agreement. The Railroad provides the UDOT Utility and Railroad Coordinator with an estimated Railroad flagging duration to complete required Crossing modifications. This duration is included in the construction and maintenance agreement. Railroads can have different review and approval processes for different components of the Crossing improvements based on the level of impact associated with a specific improvement. Refer to Section 4.2 of this MOI for more information on the review and approval process of specific Railroads.

Processing time for the Railroad agreement can take several months, so it is important to begin this step at the earliest possible time in the project development phase.

Grade Separation Structures

Submittals to UPRR for Grade Separation Structures should follow the requirements of the [BNSF Railway-Union Pacific Railroad Guidelines for Railroad Grade Separation Projects](#), Section 3, Submittals, as provided for in the Structure Tasks below. Typically, UTA follows the standards and defers structure design review and approval to UPRR for structures spanning lines belonging to or operated on by both. Plan sets should be submitted to all applicable railroad companies, with UPRR being primarily responsible for reviewing and approving the plan sets.

3S2 Develop Situation and Layout (S&L) for Minor Structures

- Request structure number
 - Submit requests through the [UDOT Structures Design and Bridge Operations website](#)
- Develop S&L Sheets
 - Submit preliminary S&L sheets to Geotechnical Engineer (if necessary)
- Provide constructability review
 - Consider phasing and impacts to Railroad operations (if applicable)
- Submit S&L sheets to Railroad
 - Submit the draft S&L sheets showing all required information.
 - Include the required Railroad information sheet in the submittal.
 - Submit the Overhead Submittal Checklist ([Appendix 2.19](#)) to the Railroad.
 - Inform Railroad that coordination and design review may continue throughout final design. However, geometry and orientation need to receive buyoff from all parties.
- Prepare initial design exception, design waiver or deviation from UDOT standards (as necessary)
 - Prepare necessary documentation and submit for approval.
- Initiate QC review
 - Follow UDOT standard QC policy for reviews.

3S3 Develop Situation and Layout (S&L) for Rehabilitation

- Request structure number
 - Submit requests through the [UDOT Structures Design and Bridge Operations website](#)
- Develop repair lists
- Develop S&L sheets
 - Generate a plan set with a general sketch of the structure to show anticipated repair work to facilitate general discussion and reviews.
- Submit S&L sheets to Railroad
 - Submit the draft S&L sheets showing all required information.
 - Include the required Railroad information sheet in the submittal.
 - Submit the Overhead Submittal Checklist to the Railroad.
 - Inform Railroad that coordination and design review may continue throughout final design. However, geometry and orientation need to receive buyoff from all parties.
- Prepare initial design exception, design waiver or deviation from UDOT standards (as necessary)
 - Prepare necessary documentation and submit for approval.
- Initiate QC review
 - Follow UDOT standard QC policy for reviews.

3S5 Develop Situation and Layout (S&L) for Bridge

- Obtain draft hydraulic/scour report (if applicable)
- Request structure number

- Submit requests through the [UDOT Structures Design and Bridge Operations website](#)
- Develop S&L sheets
 - Submit preliminary S&L sheets and preliminary structure foundation loads to the Geotechnical Engineer.
- Provide constructability review
 - Consider phasing and impacts to Railroad operations (if applicable)
- Submit S&L sheets to Railroad
 - Submit the draft S&L sheets showing all required information.
 - Include the required Railroad information sheet in the submittal.
 - Submit the Overhead Submittal Checklist to the Railroad.
 - Submit the Overhead Grade Separation Data Sheet to the Railroad.
 - Inform Railroad that coordination and design review may continue throughout final design. However, geometry and orientation need to receive buyoff from all parties.
- Prepare initial design exception, design waiver or deviation from UDOT standards (as necessary)
 - Prepare necessary documentation and submit for approval.
- Initiate QC review
 - Follow UDOT standard QC policy for reviews.

3S6 Situation and Layout (S&L) Acceptance (Minor & Major)

- Submit structural documentation package
 - Structure type selection report
 - Structure design criteria
 - Preliminary cost estimate
 - Preliminary Seismic Strategy Report
 - Situation and Layout plan sheets
 - Railroads review and acceptance
 - Initial design exception, design waiver, or deviation from UDOT standards.
 - Responses to review comments
 - QC/QA documentation
- Review structural documentation package (UDOT structures division)
- Accept S&L (UDOT structures division)

4S1 Design and Detail Rehabilitation

- Design procedures and repairs
- Develop repair plans
 - Conform to UDOT standards listed in the PDN
- Submit to Railroad
 - Submit 60% calculations and plans to Railroad for underpass structures (if applicable)
 - Submit final design calculations and plans for underpass structure

- Ensure geotechnical report is included in all submittals
- Perform load ratings
 - Provide design load ratings using methods described in the AASHTO Manual for Condition Evaluation and Load and Resistance Factor (LRFR) of Highway Bridges.
 - Provide both inventory and operating ratings.
 - Submit load rating calculations with design calculations.
 - Perform load rating analysis in VIRTIS software and submit model.
- Initiate QC review
 - Follow UDOT standard QC policy for reviews.

5S1 Deliver Final Structure Acceptance

- Submit structural documentation
 - Completed Structural Plans
 - Completed Special Provisions
 - Engineer's Estimate
 - Design Calculations
 - Load Rating Report
 - Load Rating VIRTIS Model
 - Final Seismic Strategy Report
 - Railroad Approval
 - Final design exception, design waiver or deviation from UDOT standards (as necessary)
 - Responses to review comments
 - QC/QA Documentation
 - Independent Review (if applicable)
 - Ensure geotechnical report is complete
 - Ensure hydraulic report is complete
- Submit to Railroad
 - Submit 100% calculations, plans, and specifications to the Railroad.
 - Include final geotechnical report.
- Review structural documentation (UDOT structures division)
- Accept Structure (UDOT structures division)

At-Grade and Grade Separation Crossings (as applicable)

4U3 Complete Utility and Railroad Plans and Documents

- Finalize design – finalize the Crossing design based on review comments and coordination with team members. Refer to 3U4 as needed.
- Complete Crossing improvements plan sheets – follow current UDOT CADD standards, UDOT plan sheet development standards, and Railroad standards to finalize the utility relocation plan sheets.
 - Update/include all necessary information (callouts, notes, etc.)
 - Include all necessary details

- Follow UDOT plan sheet development standards detail sheet requirements
- Enter utility relocation/ Railroad cost estimate into PDDBS based on the total amount of the agreement.
- Develop utility relocation/ Railroad project documents
 - Incorporate utility information into utility special provisions and limitations of operations.
 - Provide all special provisions required for project construction.
 - General special provisions
 - Project specific special provisions
 - Use specification writer's guide
 - Generate M&P for all bid items
 - Develop M&P for all non-standard bid items
 - Use the current measurement and payment template
 - Include accurate description for all effort and materials required for construction.
 - M&P pay items must match plan sheet pay items exactly

3.5 PROJECT AND COORDINATION TIMELINE

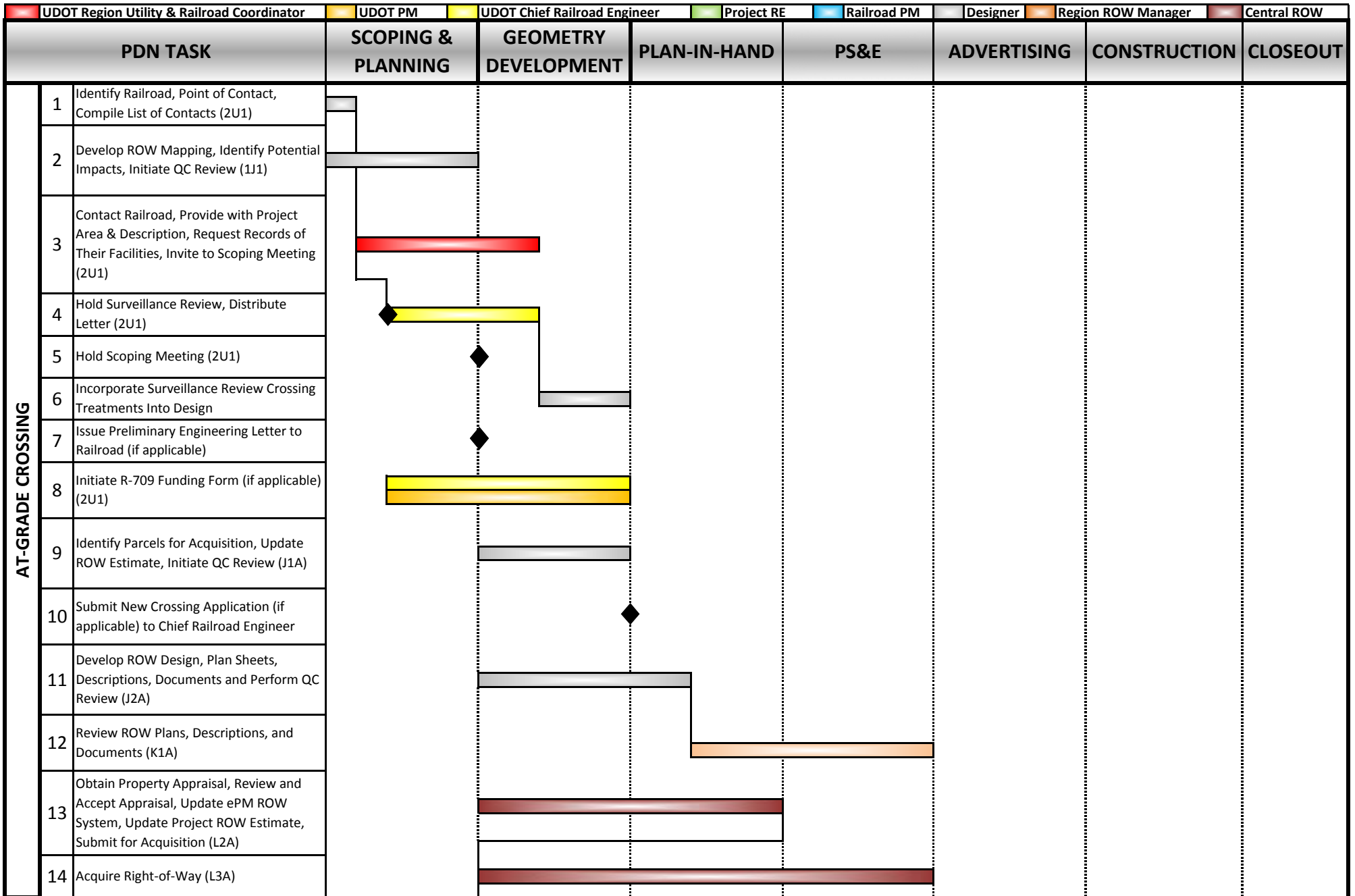

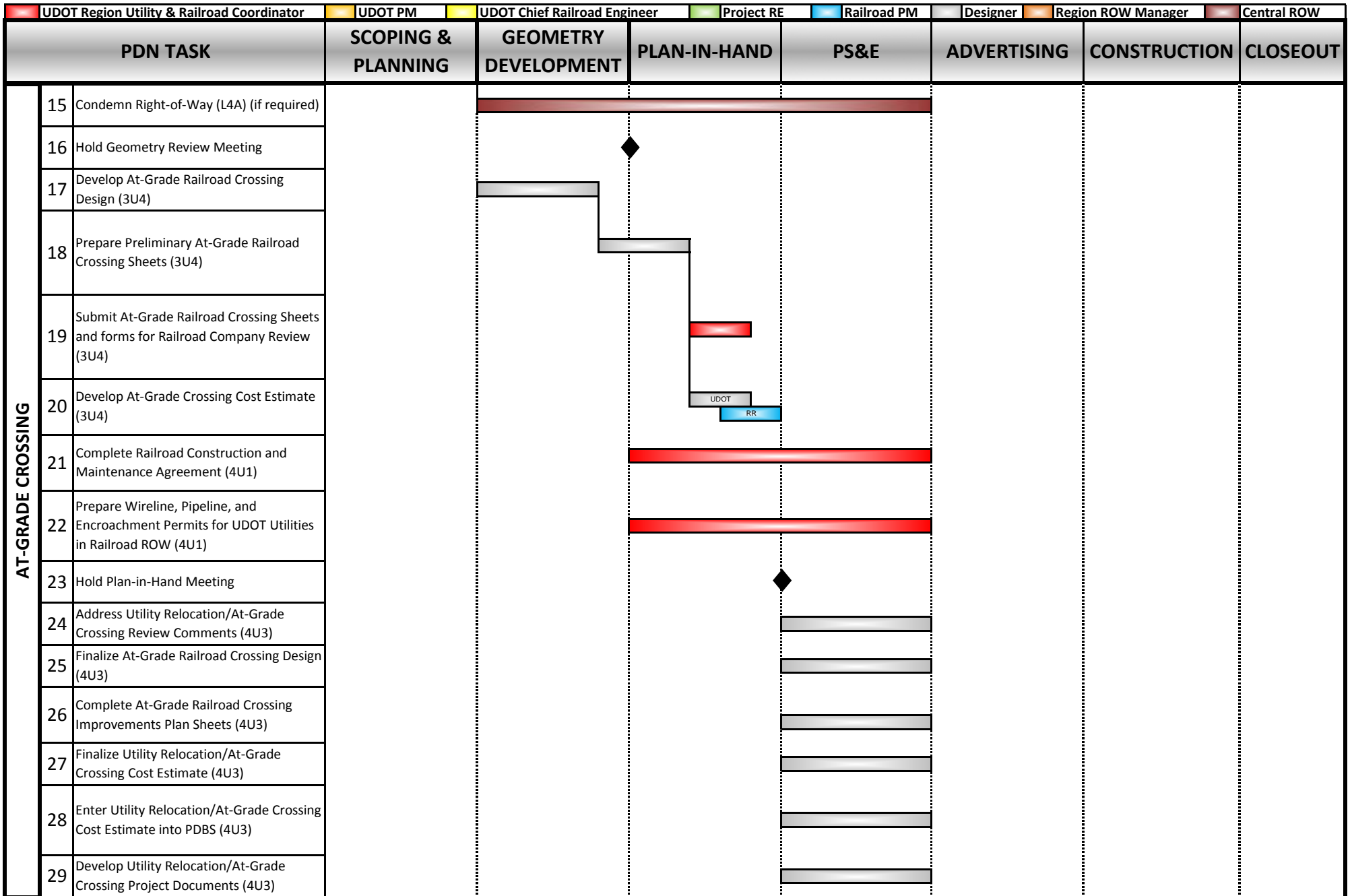

		UDOT Region Utility & Railroad Coordinator	UDOT PM	UDOT Chief Railroad Engineer	Project RE	Railroad PM	Designer	Region ROW Manager	Central ROW
PDN TASK		SCOPING & PLANNING	GEOMETRY DEVELOPMENT	PLAN-IN-HAND	PS&E	ADVERTISING	CONSTRUCTION	CLOSEOUT	
AT-GRADE CROSSING	30	Perform QC Review (4U3)							
	31	Hold PS&E Meeting							
	32	Deliver Right-of-Way Certification (5L1)							
	33	Advertise Project							
	34	Attend Pre-Bid Meeting, Meet with RE							
	35	Attend Pre-Construction Meeting (all parties involved in construction)							
	36	Attend Weekly Construction Meetings (as necessary)							
	37	Maintain updated schedules throughout the project showing railroad activities							
	38	Final Inspection from Chief Railroad Engineer							
	39	Generate Letter of Acceptance							
	40	Process any C193, C193A, C118 or any other necessary construction documents for railroad items							
	41	Complete and closeout final pay requests from railroad							
	42	Close Project							

3.6. CRITICAL ITEMS AND PROCESSES

This section is intended to outline critical items and process that can impact the scope, schedule and cost of a project.

3.6.1. RIGHT-OF-WAY PROCESSES AND ACQUISITIONS

ROW acquisitions need to be identified during the planning and scoping stage of the project. Both existing and required property boundaries and aerial ROW needs must be identified and reviewed by the UDOT project manager and the Railroads property management staff. All pertinent ROW information shall be gathered and maintained in the project file.

Depending on the ownership of the ROW being impacted, several types of property rights and access permissions may be granted. Usually these permissions are granted in the form of easements or licenses with associated fees. Coordination between the ROW owners should occur early and often in the project in order to understand the impacts to both parties.

The acquisition of property rights required for the use of Railroad property for highway purposes is included as part of the project agreements. For the modification of existing crossings, every effort should be made to review and reference the original crossing agreement and establish the limits of existing property rights when determining the additional ROW required to accommodate the project. UDOT is responsible to identify and prepare legal descriptions and ROW plats indicating the existing and proposed ROW to be acquired as a result of the project.

Union Pacific Railroad

For property rights required from UPRR, the Region Utility and Railroad Coordinator or Right-of-Way Engineer submits the ROW descriptions and plats to UPRR, through the Railroad Project Manager, for review and determination of fees for permanent and/or aerial easements required by the project. Property rights to be obtained through agreements are commonly identified as: X Parcels. UPRR calculates fees based on the area of new property required, not to include the area occupied by the existing highway facility as indicated in the original crossing agreement or previous project ROW files. Property rights and ROW are to be verified and processes per UDOT standard processes.

Upon receiving the proposed fee amount from UPRR, the project representative will submit the fee to the Deputy Director of Right-of-Way for review and approval. If the proposed fee amount is acceptable, the cost will be included in and paid under the project C&M Agreement, and the approved ROW information attached to the agreement as an exhibit. If the fee is not acceptable, the Central ROW Division will negotiate with UPRR's Property Managers to determine an acceptable fee amount. Upon approval and payment of the fee, an appropriate easement instrument will be executed, recorded and a copy retained by Central ROW for their records.

Utah Transit Authority

Consistent with the exchange of fees between UDOT and UTA, real estate usage (license) and administrative fees are waived for UDOT facilities on UDOT projects. The project representative should prepare and submit the legal description and ROW plat indicating the UTA property required by the project for review and inclusion in the license agreement to be prepared by UTA.

UDOT and UTA have established a process for maintaining a cost ledger of assets attributed to both agencies. The Statewide Utility Engineer is UDOT's designee having authority to approve items to be placed on the ledger. The ledger includes the value of property interests UTA conveys to UDOT; the value of property UDOT conveys to UTA; and the value of improvements made to real property owned by UTA and/or UDOT. Real property interests are described as properties transferred in fee and/or capital improvements on the property. The ledger will not include a value for non-fee property conveyances including, but not limited to easements, permits, licenses or agreements such as the License listed above.

When a fee title property is required as a result a Highway Project or Safety Improvement Project, the legal description and plat should be submitted to UTA for review and inclusion in the crossing agreement. If a capital improvement is part of the transaction, a value must be determined and assigned to the improvement. The UDOT Project Manager should contact the UDOT Statewide Utility Engineer to review the value of the fee title property transaction or capital improvement for entry on the ledger.

Acquiring Property Rights on Behalf of Railroads

When it is necessary to obtain replacement ROW for the relocation of Railroad facilities, UDOT is responsible to determine the size and location of the replacement property, subject to the approval of the Railroad. Replacement properties should be purchased directly into the name of the Railroad. Parcels purchased in the name of Railroads are commonly identified as: Z Parcels.

3.6.2. RAILROAD FLAGGING

The cost of Railroad flagging is typically provided by the Railroad at the expense of UDOT and incorporated into the project estimate. An approximate estimate for Railroad flagging is \$1,000/day for the duration construction activities affect the Railroad ROW. This value includes Railroad additives, contingencies and vehicles. See Chapter 5 for more detailed information on Railroad flagging requirements.

3.6.3. FEDERAL REQUIREMENTS FOR RAILROAD COMPANY PARTICIPATION IN GRADE SEPARATION STRUCTURE COSTS

23 CFR 646.210 requires that Railroads participate in the cost of projects that eliminate existing grade crossings at which active warning devices are in place or ordered to be installed by UDOT. The Railroads required 5% share of the cost is based on the costs for preliminary

engineering, ROW and construction of the structure and approaches which would have been constructed if there were no Railroad present, for the number of lanes on the existing highway and in accordance with the current design standards of UDOT. An example of a cost sharing estimate is provided in the [Appendix section 3.4](#). Where another facility such as a highway or waterway requiring a bridge structure is located within the limits of a grade separation project, the estimated cost of the theoretical structure and approaches to eliminate the Crossing should be calculated without considering the presence of the waterway or other highway. If more than one Railroads Crossing signals are being eliminated by one grade separation structure, UDOT typically prorates the 5% share of the structure costs between the companies based on the proportional lengths of the span over their respective ROW. The amount of the Railroad's share of the cost is calculated, approved and paid as a Lump Sum, and the payment is typically made when the Crossing is completely out of service and removed.

3.6.4. ENVIRONMENTAL CONCERNS

Historically, Railroad ROW have varying degrees of potentially hazardous environmental contaminants including grease, oil, diesel fuel and other hydro carbons. In the early part of the 20th century, Railroads in Utah used slag ballast that contains additional potentially hazardous, reportable levels of contaminants and metals. In some rail-banked corridors, the slag ballast can be successfully capped in place if it not disturbed. If rail corridors are to be reconfigured or if excavation and removal of potentially hazardous material is anticipated, testing, special handling and disposal methods may be required at the discretion of the Railroad. UTA in particular has extensive DEQ and EPA commitments on their corridors, commitments that are assigned to users occupying their property by License Agreement. All applicable environmental regulations and safety precautions must be followed when planning, designing and constructing Safety Improvement and Highway Improvement projects.

CHAPTER 4: RAILROAD AGREEMENTS

4.1. RAILROAD AGREEMENTS

Overview of Railroad and Highway Authority Agreements per the Rule:

- Where construction of a Highway Project or Safety Improvement Project requires use of Railroad properties or adjustments to Railroad facilities, an agreement must be prepared between UDOT and the Railroad.
- Master agreements between UDOT and a Railroad on an area wide or statewide basis may be used. Currently, UDOT has a statewide agreement with UPRR for Safety Improvement projects. This agreement contains the specifications, regulations, and provisions required in conjunction with work performed on all Safety Improvement projects with UPRR.
- On a project-by-project basis, the written agreement between UDOT and the Railroad shall include the following minimum requirements:
 - Reference to appropriate federal regulations
 - Detailed statement of the work to be performed by each party
 - The extent to which the Railroad is required to adjust its facilities
 - The Railroad's share of the project cost
 - An itemized estimate of the cost of the work to be performed by the Railroad
 - Method to be used for performing the work, either by Railroad forces or by contract
 - Maintenance responsibility
 - Form, duration, and amounts of any needed insurance
 - Appropriate reference to or identification of plans and specifications

For Highway Improvement Projects impacting most Railroads, UDOT prepares the agreement with the Railroad, including the requirements listed above, in mutually acceptable standard language. For information and examples of current agreement formats, contact the Region Utility and Railroad Coordinators. For projects impacting UTA facilities, UDOT's representative will prepare and submit a Category II Encroachment Application to UTA who will prepare and present a Crossing agreement to UDOT for review and approval. UDOT typically provides Exhibits for the Agreements including the appropriate Crossing or grade separation structure plan sheets, ROW plans and legal descriptions. The Railroad provides the cost estimates for Railroad performed work, ROW fees (if applicable), recommended flagging durations and costs; contractor's right of entry form, etc.

- On matching fund agreements between UDOT and a Highway Authority, the written agreement shall include the following minimum requirements:
 - Description of work and location, city, county, and state
 - Reference to federal regulations that matching funds will be provided by the Highway Authority

- Detailed statement of work to be performed by each party regarding design, agreements, inspection, and maintenance
- Statement of finances of project and matching funds to be provided by Highway Authority, deposits, invoices, and cost overruns or under runs
- Agreements for industry track Crossings are prepared between the Highway Authority and the industry.

To prevent a Crossing project from becoming unduly delayed, a six-month period should be expected from the issuance of the Railroad agreement to completion of work by the Railroad involved. Should more than the specified period elapse, UDOT shall require the Railroad to proceed with the work covered by the agreement under the authority contained in Section 54-4-15 and approval from the FHWA will be solicited in conformance with 23 CFR 646.

4.1.1. SUMMARY OF UPRR MASTER AGREEMENT TERMS

The terms of this UPRR Master Agreement apply to Grade Crossing Safety Improvement Projects. A separate agreement will be prepared for other Highway Improvement Projects. UPRR utility and ROW agreement include:

- Right of Entry
- Utility Crossing
- Flagging
- Preliminary Engineering

Projects covered by the UPRR Master Agreement are joint UDOT and UPRR projects funded by federal funding; as such UPRR has certain obligations it must meet to receive funding for improvements related to the Safety Improvement Project.

UPRR to Make Installations

- UPRR will, at the expense of UDOT, furnish all necessary plan, specifications, material estimates, labor, material, flagmen, equipment and will install all appurtenances and surface improvements within UPRR's ROW. UPRR will not begin installation of appurtenances and surface improvements until authorization is received from UDOT.

Prior Notification of Work

- UPRR will provide 48 hour notice to UDOT's RE before performing any work covered by these agreements.
- In certain circumstance UPRR may experience a circumstance that necessitates the performance of emergency work which may interrupt work on the Safety Improvement Project. However, UPRR must notify the RE when work is expected to continue. Failure to do so could result in disallowance of reimbursement for any portion of the Railroad's unsupervised work on the project.

- On projects where the work can be accurately estimated and UDOT and the UPRR have agreed to lump sum payment as described in 23 CFR 140 Subpart I & 646 subpart B, there will be no requirement for daily record keeping nor for audit and reimbursement shall be made in conformance with Section 6 of this agreement. However, prior notification requirements still apply.

Maintenance and Operation of Warning Devices

- Typically, UPRR is responsible for the maintenance of active and passive warning devices located in the Railroad ROW. The Highway Authority is typically responsible for passive warning devices (signs and pavement markings) outside the Railroad ROW.

Maintenance and Operation of Crossing Surface Improvements

- UPRR is responsible for maintaining the Crossing material within the Railroad ROW and two feet beyond each outside rail for Crossings without concrete panels or to the edge of concrete panel if such panels are installed. Surface material not defined as UPRR's responsibility above is the responsibility of the Highway Authority.

Interference with UPRR Operations

- All UDOT work associated with Safety Improvement Projects, including maintenance of Highway facilities and appurtenances constructed on UPRR property will be performed without interruption to or delay to UPRR operations or of others lawfully occupying or using the property of facilities.
- UDOT shall not do, suffer or permit anything that will or may obstruct, endanger, interfere with, hinder or delay maintenance or operation of the UPRR's tracks or facilities, or any communication or signal lines, installations or any appurtenances thereof.

Protection of Fiber Optic Cables Systems

Fiber optic cable systems may be buried on UPRR's property. UDOT or its contractors shall telephone UPRR at 1-800-336-9193 (a 24-hour number), to determine if fiber optic cable is buried anywhere on the Railroads premises to be used by UDOT. If it is, UDOT will telephone the telecommunications company(ies) involved, arrange for a cable locator, and make arrangements for relocation or other protection of the fiber optic cable prior to beginning any work on the Railroad's premises.

4.1.2. SUMMARY OF RAILROAD AGREEMENT TERMS

This section is intended to highlight common terms and conditions of Railroad license agreements. The UDOT Project Manager should consider these elements early in the project development process in order to develop an understanding of how these terms and conditions could affect the project. Railroads typically tailor agreements to the requirements and specifics for each project, but they will generally start with a standard form of an agreement. Standard

forms of various Railroads can be found in the appendix of this document. Agreement types include:

- Crossing Grade Separation
- Pipeline Crossing
- Wire line Crossing
- Trail
- Temporary Right of Entry
- Contractor Right of Entry – there often are separate right of entry agreements for each type of project

Following is a list of terms and conditions for consideration by the UDOT PM:

- License and Fees
 - Administrative fees – in certain cases Railroads will waive fees. For example, UDOT and UTA have an exchange of fees provision where UTA will waive administrative fees for UDOT projects
 - Also, for aerial structures UTA will waive license fees/real estate usage charge because the agency wants to encourage grade separations
 - For pipeline or wire line crossings, Railroads typically require a license fee/real estate usage charge. This fee can be a onetime fee or annual fee. Again, in the case of UTA, the agency has entered into an agreement with UDOT where the value of a fee is put in an exchange ledger to be traded for like value at an appropriate time.
- Access to right-of-way
 - Some Railroads require right of entry agreement for any access to their ROW, but UPRR no longer requires a right of entry agreement. Typical provisions of right of entry agreement include:
 - A notice period for entry for construction or maintenance
 - The right to enter will be specific to the time, activities and plans must be provided with a summary of methods and manner of work to be performed
 - Applicable training requirements
 - Track access permit
 - Emergency access – allows access in situations where there is a threat of imminent and serious injury or damages to persons and properties
- Construction & Maintenance
 - A requirement that all construction and maintenance of UDOT facilities within the Railroad ROW must be consistent with final design plans reviewed and approved by the Railroad
 - Aerial structures serving both UTA and UPRR will be designed in accordance with UPRR standards and guidelines, UPRR will be the initial approving authority for design and construction, but UTA retains its right to review the plans

- A requirement for UDOT and its contractors to investigate and protect utilities – Railroad agreements require the project be “blue staked” and clearly marked before excavation
- Fiber optic cables – because of the linear nature of railroad ROW, they make excellent fiber optic utility corridors. Many Railroad ROW contain fiber optic utilities. Below is sample indemnification language from UTA’s license agreements regarding fiber optic cables.
 - “It is expressly agreed between UTA and LICENSEE that LICENSEE’s obligation to indemnify is limited to the dollar amounts set forth in the Governmental Immunity Act, to the extent such claims are covered by the Act. Licensee’s agreement to indemnify shall not be deemed to be a waiver of the defenses and provisions of the Governmental Immunity Act by LICENSEE.”
 - In joint UTA, UPRR corridors UDOT shall telephone UNION PACIFIC RAILROAD COMPANY during normal business hours (7:00 a.m. to 9:00 p.m. Central Time, Monday through Friday, except holidays) at 1-800-336-9193 (also a 24-hour, 7-day number for emergency calls) to determine if fiber optic cable is buried near the location of the Pipeline. If so, Licensee will telephone the telecommunications company(ies) involved, make arrangements for a cable locator and, if applicable, make arrangements for relocation or other protection of the fiber optic cable. Licensee shall not commence any work until all such protection and/or relocation (if applicable) have been accomplished.
- Construction Observation
 - UDOT to bear all costs – Railroads will furnish engineering review, flagmen and field inspectors as Railroads deem necessary to protect their operations during the progress of the work and will inspect the work performed by LICENSEE’s contractor on Railroad property
 - Railroads will retain the right to suspend work if they deem the construction or maintenance is being performed in a manner that creates a risk to the ROW or the operations conducted therein.
 - Railroads strictly enforce how close to operating track they will allow their own personnel and especially third parties to get without flagging protection. Below is the language from UTA’s license agreements and it closely mirrors that of UPRR.
 - “LICENSEE’s CONTRACTOR AND/OR THEIR SUBCONTRACTORS SHALL AT NO TIME ALLOW EITHER PERSONNEL OR EQUIPMENT TO BE CLOSER THAN TWENTY FIVE (25) FEET TO UTA’S TRACK WITHOUT THE PRESENCE OF A UTA FLAGMAN. When not in use, the contractor’s equipment shall be removed from UTA’s right of way or at least fifty (50) feet from the centerline of UTA’s nearest track if within UTA’s right of way.”
- Subordination of Rights Granted
 - Railroads will review all use/license requests to determine the extent to which the proposed use limits or hinders its current or future use of the ROW. In some cases

Railroads may require UDOT to demonstrate, by master plan, how the proposed use will or will not affect future Railroad use of the ROW.

- Relocation and modification of improvements - below is UTA's relocation language and it generally mirrors that of other Railroads.
 - Grade separated structure
 - To the extent that a modification to a grade separated crossing is necessitated by the construction, reconstruction, modification or relocation of any UTA System, UTA shall be responsible for the costs of such relocation
 - To the extent that a modification to a grade separated crossing is necessitated because the grade separated crossing is conflicted with or causing interference with any UTA or third person track improvements or utilities existing prior to the construction of the grade separated crossing, then UDOT shall be responsible for the costs of such relocation.
 - Wire lines or pipelines
 - UTA's wire line and pipeline relocation provisions are strong. Typically the requirement is that the licensee shall, at its sole cost and expense and within 30 days after receipt of written notice from UTA, modify the pipeline, relocate all or any portion of the pipeline to such new location in the ROW as UTA may designate, or (if neither modification nor relocation is practicable) remove the pipeline entirely from the ROW whenever, in furtherance of its needs and requirements, UTA shall find such action necessary or desirable. All the terms, conditions and stipulations herein expressed with reference to the pipeline on UTA's property in the location described herein shall, so far as the pipeline remains on UTA property, apply to the pipeline as modified or relocated pursuant to this Section. UDOT shall not be entitled to any damages or other compensation as the result of UTA's exercise of its rights under this paragraph. UTA agrees to exercise its rights under this Section in good faith.
 - UTA also makes no warranties to any outstanding superior rights previously conveyed or granted to third parties by UTA or its predecessors in interest or the right UTA to renew and extend the same
- Indemnity and Release
 - Indemnity provisions will vary by Railroad, but in most cases Railroads will require UDOT to protect, defend, release, indemnify and hold harmless, and any successors, contractors, officers, directors, agents and employees of the Railroad, from and against any and all Losses resulting from
 - Negligence in conjunction with any construction, maintenance or other work...
 - Negligence in the use or operation of the structure...
- Termination – will vary by Railroad, below is UTA's termination language
 - For grade separated structures, UTA retains the right to terminate the agreement if UDOT ceases to use the grade separated crossings in an active substantial way for any continuous period of 5 years

- For wire line and pipe line crossings all utilities must be removed and the UDOT's sole cost and expense and restore the ROW in a least as good a condition as existed at the time the licensee entered the ROW.

4.2. HIGHWAY CROSSING DESIGN SUBMITTALS

The UDOT Project Manager or UDOT Region Utility and Railroad Coordinator shall notify the Railroad Project Manager of proposed work and anticipated scope and coordinate with them during the Planning/Scoping Stage of the project. 30% or 60% crossing design drawings should be sent to the Railroad Project Manager and UDOT Chief Railroad Engineer for review. Crossing agreements between UDOT and Railroads will not be finalized until the Railroad and the UDOT Chief Railroad Engineer have reviewed, commented on and approved the 100% crossing design plan set. The time required to complete this process varies between Railroads. Coordination should be made to ensure the project schedule is not delayed by this process.

4.3. GRADE SEPARATED CROSSINGS

In General, design plan submittals for overhead structures (highway over) should be made at Concept, 30% and 100%. Concept submittals should include concept plans and site pictures. 30% plan submittals should include the situation and layout sheets indicating that the minimum design and safety requirements have been addressed, as per the overhead structure submittal requirements of UPRR. Project specifications, drainage reports, geotechnical reports, shoofly design (if applicable) should also be provided. Plans and specifications for rehabilitation projects on structures over Railroad facilities must also be submitted to the Railroads for information, review and determination if an agreement between the Railroad and UDOT is required.

Even though overhead structure agreements between UDOT and the Railroads are typically finalized based on approval of the 30% plan submittal, final signed and stamped 100% structure plan sets, project specifications, special provisions, drainage reports, and geotechnical reports are to be submitted to the Railroad for their records.

Underpass structures (railroad over) require the submittal of additional structural calculation details and full plan sets. Please refer to the [Grade Separation Guidelines](#) for complete instructions. Agreements for underpass structures are typically not finalized until the 100% structure design has been approved by the Railroad.

4.4. RECEIVING AND REVIEWING RAILROAD PRICE PROPOSALS

4.4.1. ANTICIPATED COSTS ASSOCIATED WITH CROSSING PROJECTS

Below is a table outlining general costs associated with a crossing project. All projects are to be treated on a case-by-case basis; the costs provided simply offer a general idea as to what a reviewer may anticipate for crossing components. This reference may be useful when planning

and scoping discussions are taking place with stakeholders. Being able to identify how certain aspects of the crossing may impact cost is a large benefit to the decision making process.

Typical Railroad Component Costs to a Project				
Item	Units	Safety Projects	Highway Projects	Notes
Crossing Surface (Concrete Panels)	L.F.	\$1,500	\$2,000	Crossing Surface includes all materials required for a complete crossing. Items include but are not limited to: ballast, track, panels, pavement, rubber insulation, etc... Length shall be measured along centerline of track across roadway and include a 2 ft. panel extension on either side of the roadway pavement, travelled way or sidewalk depending.
Lights & Gates	EA	\$137,000	\$175,000	Includes materials, labor and installation. Track circuitry, signal houses, foundations, etc... should be included in this cost.
Flagging	Per Day	\$1,000	\$1,000	Includes certified railroad flagmen.
Cantilever Structure	EA	\$50,000	\$50,000	Cost of Cantilever structures vary greatly from project to project depending on numerous factors such as length, number of traffic lanes, number of flashing light pairs, and soil stability.

4.5. AGREEMENT IMPLEMENTATION

Railroad Agreements can be drafted and the support documents compiled by the UDOT Utility and Railroad Coordinator or by consultant team members. If agreements are compiled by consultants or design build teams, they should be forwarded to the UDOT Utility and Railroad Coordinator for review and processing. The Agreement must be signed by the Region Director or designated Project Director for execution by UDOT. The Agreement should be signed by all parties and incorporated into the project documents prior to advertising the project for bids.

Agreements with railroad companies on Federal Aid projects must be forwarded to FHWA for review and approval.

Copies of executed Railroad Agreements are to be distributed to the Project Manager, Resident Engineer, Contracts, Estimates and Agreements Supervisor, Internal Audit, Planning and Programming and the Comptroller's Office.

Upon receipt of the executed agreement copies, the Contracts, Estimates and Agreements Supervisor will enter the agreements into PDDBS under Utility Agreements.

4.6. SUPPLEMENTAL PROJECT AGREEMENTS

Supplemental project agreements may be required depending on the type of project and any special characteristics that are not defined in the overall project agreement. Coordination between the UDOT Region Utility and Railroad Coordinator and the Railroad Project Manager should begin the process if needed.

CHAPTER 5: RAILROAD COORDINATION DURING CONSTRUCTION

The most important aspect of Railroad coordination during construction is safety; the safety and protection of the highway and Railroad workers, the travelling public, the protection of property and the Railroad's operations. Effective coordination and compliance with Railroad requirements is vital to the success of projects with Railroad facility impacts. Standard Specification 00725 Scope of Work, 1.15 Railway-Highway Provisions, gives UDOT's contractors specific instructions and responsibilities for coordinating with Railroads. It is important that the UDOT RE ensure that contractors strictly comply with the standard specification while working on projects with Railroad involvement. The contractor is given further instructions as part of the contractor's right of entry agreement that is required before work can begin on Railroad property

A full project contact list should be generated at the beginning of any construction project with listings of ALL participants in the project. The contact list should be updated as necessary by the RE throughout the project. Railroad representatives, inspectors and managers should have access to the full contact list.

All construction operations shall also conform to and refer to the [UDOT Construction Manual of Instruction](#).

5.1. PRECONSTRUCTION CONFERENCE, NOTIFICATION TO RAILROAD

UDOT's contractor is required to hold a preconstruction conference at least 15 days before beginning any construction work on Railroad ROW and to give written notice to the UPRR Manager of Industry and Public Projects, UTA Sr. Program Manager of Operations, or equivalent position for the Railroad. The contractor is responsible to coordinate the work schedule with the Railroad.

5.2. CONTRACTOR RIGHT OF ENTRY

Right of entry agreements must be obtained by the highway contractor prior to commencing work within or encroaching on Railroad ROW. Instructions for obtaining [Right of Entry Agreements](#) are available through the UPRR website or by contacting the Railroad Project Manager identified in the project contact sheet. Right of entry agreement forms are occasionally provided to UDOT as part of the project agreement.

The contractor right of entry form from UTA can be obtained by submitting an application to the Property Administrator identified in the contract documents. A copy of the UTA application is included in the Appendix.

Contractor right of entry agreements bind contractors to strict requirements for safety, coordination and liability requirements on a project. A copy of the contractor's right of entry

agreement must be provided to the UDOT RE and also kept on site during the completion of the work.

The contractor must give at least 48 hours verbal notice to the manager of track maintenance identified in the contractor's right of entry agreement before beginning work

5.3. INSURANCE REQUIREMENTS

Insurance requirements vary by Railroad and the type and scope of the project. In general, Contractors are required to provide proof of commercial general liability, business automobile, workers compensation & employer's liability, railroad protective liability, umbrella or excess, and pollution liability coverage before right of entry will be granted.

UTA's Insurance Requirements are in [Appendix section 3.2.5](#).

[UPRR's Insurance Requirements](#)

5.4. FLAGGING & PROTECTIVE SERVICES

Flagging

UDOT's standard specifications provide that UDOT does not reimburse Contractor's for Railroad flagging and inspection. Contractors are instructed to determine the cost of required Railroad flagging, inspection and cleanup and to include the cost in mobilization. UDOT pays the Railroad directly for verified billings and deducts payment from the Contractor's pay estimates under a construction accounting item for Railroad flagging, inspection and cleanup. No other compensation for this item is allowed.

Under this payment approach, the contractor is responsible to determine the anticipated cost of Railroad flagging required based on their schedule for the completion of the work, and to insure that the cost is covered in their mobilization item. The contractor must take into account the notice required to order and release a flagger, gaps in the work schedule, double shift work, weekend work and holiday work, when anticipating the cost of flagging that will be required. The estimated cost of flagging protection by UPRR is \$1000 for a 12 hour day and \$990 per day for UTA. These prices include additives, contingencies and vehicle. Refer to the Contractor's Right of Entry form for more information.

According to the UDOT standard specifications, the contractor is also responsible for the cost of inspections performed by the Railroad during the construction of the project, and any cleanup of the Railroads property that is required as a result of the contractor's operations.

At no time unless expressed written consent is obtained from the Railroad can UDOT or its contractors allow either personnel or equipment to be closer than twenty-five (25) feet of UPRR's track or ten (10) feet of UTA's track without the presence of a Railroad flagman. When equipment is not in use, it shall be kept at least fifty (50) feet from the centerline of the Railroads nearest track.

Railroad flagmen, inspectors or managers typically have the right to stop work on or through the property of the Railroad if the work being performed is deemed hazardous by the Railroad to its property and/or operations. Additionally, flagmen, inspectors or managers have the right to stop work on or through the property of the Railroad if the work being performed is contrary to the project plans, specifications and/or Railroad guidelines.

Form B Track Designation

A "Form B" track designation is the Railroads method of alerting train traffic to construction activities within the Railroad ROW. It informs train crews where and when construction zones effect Railroad tracks, and instructs the train crew to contact the Employee in Charge (EIC) or Railroad flagman before entering the construction zone. The Form B also provides train speed and notice (sound horn / bells) restrictions within the construction zone.

When a train approaches a Form B construction zone, the train crew contacts the EIC and requests instructions for traveling through the construction zone. The EIC alerts construction crews of the approaching train, ensures that all men and equipment are clear of the track before allowing the train access, and then provides instructions to the train crew. The EIC monitors train traffic and the construction crews, and must not perform other duties while providing flagmen protection. Additional information on Form B track designation may be found in the [Appendix section 3.3](#).

Railroad Operations, Work Windows

UDOT's contractors are responsible to coordinate work windows with UDOT and the UPRR. Conditional work windows are periods of time when Railroad operations have priority over construction activities. This is the normal status during work on projects when flagger protection is provided.

An Absolute Work Window is when construction activities are given priority over Railroad operations, such as when tracks are taken out of service for bridge demolition or girder placement. Any request for an Absolute Work window must meet strict requirements, requires advance planning and a detailed explanation for review and approval by the Railroad.

5.5. SAFETY TRAINING REQUIREMENTS

It is the responsibility of the UDOT contractor to ensure all personnel performing work within or encroaching on a Railroad ROW, including but not limited to the contractor's employees, subcontractors, UDOT personnel, and Inspectors have the necessary training and credentials. Training requirements for each Railroad vary; see below for training requirements for specific Railroads.

UPRR:

Roadway Worker Protection (RWP) www.railroadeducation.com

Contractor Orientation Course(s) and Photo ID Badges for Contractors (UPRR)
www.contractororientation.com

Minimum Safety Requirements for Contractors
<http://www.uprr.com/reus/group/contract.shtml>

UTA:

Roadway Worker Protection (RWP) www.railroadeducation.com

Contractor Orientation Course(s) and Photo ID Badges for Contractors (UTA)
www.contractororientation.com

UCRY:

Roadway Worker Protection (RWP) www.railroadeducation.com

SLGW:

Roadway Worker Protection (RWP) www.railroadeducation.com

UTAH:

Roadway Worker Protection (RWP) www.railroadeducation.com

If work is being performed in, around or through a Railroad not listed above, the UDOT RE shall contact the Railroad to determine what training requirements and credentials are necessary for work within the ROW. While contractors may provide Railroad worker safety training, this training does not supersede the training and certifications provided by the Railroad.

The UDOT RE shall keep safety related records of all personnel working within the Railroad ROW, including training certifications, expiration dates of said training and attendee lists from daily safety briefings.

5.6. MINIMUM SAFETY REQUIREMENTS FOR CONTRACTORS

5.6.1. PERSONAL PROTECTIVE EQUIPMENT (PPE)

The items listed below are minimum requirements for personnel entering or working within a Railroad corridor. Additional PPE, i.e. respiratory protection, hand protection, electrical protection, face protection, etc... may be required depending on the type of work being performed. All PPE shall conform to OSHA and Railroad standards and requirements.

- 4 point minimum suspension hard hat
- Steel toe boots with ankle protection
- Proper rated safety glasses
- High visibility reflective clothing

- Proper rated ear protection

Company specific safety requirements are provided as part of the Contractor's Right of Entry Agreements.

5.7. CONSTRUCTION SUBMITTALS

Bridge Demolition and Removal Plans

On projects that include the removal of existing highway structures, the contractor is responsible to submit a demolition and removal plan in accordance with UPRR's guidelines. A copy of the guidelines is included in the Appendix.

Guidelines for Temporary Shoring

If required as part of the planned construction, the contractor is responsible for the design, construction and performance of temporary structures and shoring in compliance with BNSF/UPRR guidelines. A copy of the guidelines is included in the Appendix.

Site Specific Safety Plans

If conditions at the site of the Railroad work warrants, the contractor may be required to provide a site specific safety plan for approval by UDOT and the Railroad. If environmental testing indicates the presence of hazardous contaminants in soils to be excavated as part of the project, a Health and Safety Plan (HASP) will be required.

5.8. CONSTRUCTION FORMS

Construction forms may be found at the [UDOT Construction Forms](#) website.

(Refer to [Minimum Sampling and Testing Requirements](#) for materials acceptance and documentation requirements and forms)

Refer to the UDOT Construction Manual of Instruction for a full list of all construction forms and documents to be completed as needed for each construction project. Form [C193](#) and [C193A](#) will most likely need to be completed for all crossing projects. The [C118](#) form may need to be completed if overrun funding is required.

5.9. RAILROAD RESPONSIBILITIES DURING CONSTRUCTION

During the course of construction, and at periods prior, the Railroad representative will need to participate in several project and construction related activities.

- Attend project preconstruction meeting.
- Attend necessary weekly construction meetings in order to understand upcoming tasks being performed on the project and how they may impact the Railroad and the project.

- Maintain contact with the project contractor and the UDOT RE throughout the Railroads involvement on the project. Topics to discuss may include but are not limited to:
 - Work activities
 - Schedule
 - Foreseeable setbacks or time constraints
 - Safety practices for all personnel operating around the rail corridor
- Conduct daily and shift safety briefings including all Railroad personnel and any highway construction personnel that may be impacting the rail corridor during their daily activities.

Obtain and maintain all proper permits and fees associated with the rail work, including Form B permits and entry permits.

5.10. RAILROAD PERFORMED WORK

When a Crossing is installed or modified as part of a Highway Improvement or Safety Improvement Project, the track, Crossing surface and signal installation work is typically completed by the Railroad or by contractors procured by the Railroad. UDOT reimburses the Railroad for 100% of the cost of the work based on actual costs determined upon completion. Federal regulations give strict guidelines on what costs are reimbursable. Other reimbursable Railroad work includes preliminary engineering, inspection, flagging and administrative costs. More information about reimbursable work is included in 23 CFR 646.

5.11. UDOT RESIDENT ENGINEER RESPONSIBILITIES

The UDOT RE is responsible to be familiar with and enforce the provisions of the UDOT Standard Specifications, Special Provisions and agreements with the Railroad(s) during the duration of the project. Copies of the Railroad agreements, approved contractor's right of entry agreements, demolition plans, shoring plans, etc. must be on file in the project office. The UDOT RE will ensure that the contractor is providing the proper notification and holding the required meetings with the Railroad representatives, and to ensure that all appropriate safety measures are in place during the work.

As with all contract work that is completed on a force account, actual cost basis, the UDOT RE or his/her representative is required to keep daily records of the labor, materials and equipment used by the Railroad in the completion of the work to be kept on file in the project office. The UDOT RE should specifically note the date the work physically began and the date the work was completed. The requirement for daily record keeping also applies to Railroad flagging, inspection and cleanup work as well as actual construction work performed by Railroad forces on Crossing installations and modifications.

If there is a change in the scope of the Railroad work required on the project, a Change Order to the executed agreement should be prepared. Utility Change Orders are completed in PDBS, and a UCOFN is prepared to fund the cost of additional work, if applicable.

CHAPTER 6: PROJECT BILLING AND CLOSEOUT

Railroads are instructed to submit billings for work on projects, including supporting documentation, to UDOT's contracts, estimates and agreements supervisor in the main construction office at the Rampton Complex. The contract's estimates and agreements supervisor will log the billings into PDBS under Utility Invoices referencing the agreement No. and forward copies of the billing to the appropriate UDOT RE for review and authorization for payment. Transmittal of billings is typically done electronically to speed processing of the billings. Billings for Railroad flagging, inspection, and force account work may be submitted progressively, or may be submitted as one final billing upon completion of the work on the project. Railroads are requested to submit billings within 120 days of the completion of the work on the project. Failure to submit billings within 6 Months for UTA and 2 Years for UPRR may result in the disallowance of payment.

The UDOT RE is responsible to keep daily records of work accomplished on the project, verify that the work represented by the billing has been completed, and approve the billing for payment. Authorization for payment, in the form of a signed cover letter or statement on the billing form, should be returned to the contracts, estimates and agreements supervisor who will enter the payment into PDBS and forward the billing to the comptroller's office for payment. Payment will be made within 60 days of UDOT's receipt of the billings. The UDOT RE is not expected to document reimbursable Railroad work that takes place off site such as engineering review, real estate costs, signal system assembly, etc., nor to perform a detailed audit of the billing. It should be assumed that these costs were incurred in support of the project during preconstruction, prior to the physical work on the project site being completed. If the UDOT RE has any questions about preconstruction or other costs reflected on the billings, they should confer with the Region Utility & Railroad Coordinator for clarification. A detailed audit of all costs represented in the billings will be performed by UDOT's internal audit section before final payment to the Railroad is made.

If the UDOT RE has legitimate concerns with the costs represented in the billings, the costs in question should be identified and withheld from the authorized for payment amount, and the verifiable amount of the billing should be approved for payment. A detailed explanation of the disallowed work and cost should be provided to the Railroad and the contract's estimates and agreements supervisor, who will forward the billing to internal audit for review and recommendation. Should internal audit determine that the costs are eligible for reimbursement, the UDOT RE will authorize the additional costs for payment based on that determination.

In accordance with the standard specifications, upon verification and payment of Railroad billings, the UDOT RE will deduct payment for Railroad flagging, inspection and cleanup from the contractor's pay estimate under a construction accounting item for "Railroad flagging, inspection and cleanup". The UDOT RE establishes this line item by selecting it from the pull down menu in the Add a Detail option in PDBS. Costs for preliminary engineering review, real

estate fees, and construction work performed by Railroads or their contractors are 100% UDOT costs and are not backcharged to the contractor. It is particularly important that the UDOT RE monitor and document the reimbursable work being performed on behalf of the contractor, including the scheduling of Railroad flagging, to ensure that the worksite is safe and that the contractor understands how flagging costs are billed against the project. It is also important to make the appropriate deductions in a timely manner during the completion of the work. If progressive billings are being received, it's not recommended to accumulate the costs until the end of the project. In any case, deductions should be anticipated to ensure that adequate retention is available to withhold the contractor's share of Railroad costs before the final estimate is processed. It is acceptable to allow contractors to review and comment on Railroad billings that will be withheld from their pay estimates, but it is responsibility of the UDOT RE to document and determine the appropriateness of the billings. The contractor should not be allowed to refuse payment for flagging costs incurred due to poor or inadequate planning and scheduling, nor to perform work within the proximity of tracks without flagging protection for the purpose of lowering their costs.

If at any time the total amount of the verified billings exceeds the estimated amount of the original, executed agreement without a change in the scope of work, the UDOT RE will be notified and a UCOFN must be prepared to explain the overrun and appropriate additional funds to the agreement.

Upon receipt of the Railroad's final billing for the project, the UDOT RE will verify the billing, complete Form C-193 and C-193A, and forward the billing along with the daily force account records, to the contracts estimates and agreements supervisor for payment and forwarding to internal audit for review and concurrence. Railroads are required to maintain records for the work performed on projects for a period of three years from the date of the final billing submittal to allow audit by UDOT and FHWA, if applicable. Upon completion of the audit, internal audit will issue a report indicating the allowable amount of the actual costs incurred by the Railroad or the amount disallowed for payment under the requirements of 23 CFR 646. If the audit discloses that the Railroad has been previously overpaid, they are required to reimburse UDOT of the cost of the overpayment. If the Railroad has been underpaid, UDOT will reimburse the additional amount of the underpayment.

CHAPTER 7: UTILITY ENCROACHMENTS IN RAILROAD RIGHTS-OF-WAY

7.1. UTAH TRANSIT AUTHORITY

UTA categorizes incidental uses of its ROW into Category I and Category II uses. Category I uses typically apply to perpendicular utility crossings and minor encroachments. Consideration should be given to whether a utility is new or replacing an existing utility covered by an existing agreement. The description of Category I and II uses and associated procedures are described below. A copy of the application process for each is also included in the Appendix.

Category I: Utility Crossing / Minor Property Use License Procedure

This procedure is intended for the individual or business entity that needs to install and maintain facilities (utility lines, minor general property uses, etc.) across, over, or under UTA property or track corridors. Anytime a utility is to be installed across UTA property or relocated as part of a highway project. A Category I Application must be submitted. Typically, Category I uses require payment of an administrative fee and a one-time real estate usage charge. Third party utility installations and relocations are required to pay fees and the real estate usage charge. By mutual agreement, UDOT and UTA waive real estate usages charges and administrative fees for UDOT facilities.

1. The review-approval process for the License will begin once UTA has received from applicant all of the following items:
 - a. A completed Category I License Application. (Applications may be obtained via E-mail, fax or mail, by contacting UTA property administrators at (801) 237-1916 or 1995.)
 - b. A \$1000 administrative fee made out to Utah Transit Authority. (Fee is waived for UDOT facilities)
 - c. A written summary of the License desired.
 - d. An area map identifying the portion of the property / corridor to be encumbered.
 - e. An engineered drawing (Plan and Profile) that includes the following:
 - i. The location and dimension of the UTA property / corridor.
 - ii. The location and dimension of any adjacent streets.
 - iii. The location of the centerline (or footprint) of the proposed facility.
 - iv. The depth of the conduit or other facility. (UTA conduit depth requirements: Steel = 6 feet, PVC = 11 feet)
 - v. The type, size and thickness of the conduit and line.

2. Application materials may be mailed or delivered to:

Property Administrator
Utah Transit Authority
669 West 200 South
Salt Lake City, UT 84101

OR

Applicant may request a meeting with UTA property staff to deliver the application materials and introduce or clarify the request.

3. The customary time for UTA staff to review, approve, create and execute a minor property use or ROW “crossing” license agreement is approximately 45 days (from the day that an acceptable drawing is received). If this time frame does not meet the applicant’s needs, accommodations for expedited processing may be considered and granted for an additional fee of \$2,500.

Category II: General Encroachment / Grade Crossing License Procedure

UTA’s Category II General Encroachment is for the individual or business entity desiring to install and maintain facilities or structures (longitudinal utility lines, buildings, road crossings, etc.) across, over, or under UTA track corridors. Anytime a UDOT project will impact a UTA Corridor, a Category II application must be filled out and submitted to UTA. Category II Licenses typically require the payment of fees and a one-time real estate usage charge. By mutual agreement, real estate usages charges and administrative fees are waived for UDOT facilities.

1. The review-approval process for the License will begin once UTA has received from applicant all of the following items:
 - a. A completed Category II License Application (Applications may be obtained via E-mail, fax or mail, by contacting UTA property administrators at (801) 237-1917.)
 - b. A \$1,000 deposit towards the administrative fee. Make check payable to Utah Transit Authority. (waived for UDOT facilities)

Two (2) copies of the following:

1. A written summary of the License desired.
2. An area map identifying the portion of the property / corridor to be encumbered.
3. An engineered drawing (Plan and Profile) that includes the following:
 1. The location and dimension of the UTA property / corridor.
 2. The location and dimension of any adjacent streets.
- c. The location of the centerline (or footprint) of the proposed facility.

- d. The depth of the conduit or other facility. The type, size and thickness of the conduit and line.
2. Application materials may be mailed or delivered to:

Property Manager
Utah Transit Authority
669 West 200 South
Salt Lake City, UT 84101

OR

Applicant may request a meeting with UTA property staff to deliver the application materials and introduce or clarify the request.

3. The customary time for UTA staff to review, approve, create and execute a Cat. II general property use or ROW “encroachment” license agreement is at least 90 days (from the day that an acceptable drawing is received). Cat. II requests must be reviewed and approved by UTA Development Review Committee (DRC), which meets monthly. Complex issues may require more than one review by the DRC.

7.2. UNION PACIFIC RAILROAD COMPANY

Encroachments are longitudinal installations of utility facilities in UPRR’s ROW. Crossings are pipelines or wirelines crossing the ROW perpendicularly.

Anytime a new UDOT facility such as a storm drain, ATMS System, etc. is to be permanently installed or relocated across UPRR Property, an application for wireline or pipeline crossing must be prepared and submitted to UPRR for review and approval in UDOT’s name. The proposed installation must meet all applicable UPRR specifications UPRR prepares the wireline or pipeline agreement for execution by UDOT. Since contractor right of entry agreements are no longer required by UPRR for most wireline and pipeline installations, payment of the applicable fees and proof of insurance must be provided by the owner of the facility in order for UPRR to execute the agreement.

Any third party utilities being installed or relocated as the result of a highway improvement project must obtain wireline or pipeline agreements with UPRR in their own name, including payment of fees and proof of insurance.

Complete instructions for making application for encroachments, wireline or pipeline crossings of UPRR ROW are available on their website through the following links:

[UPRR New Pipeline Installation](#)

[UPRR Pipeline Installation Engineering Specifications](#)

CHAPTER 8: MAINTENANCE COORDINATION

Administrative Rule R930 establishes maintenance responsibilities for the appurtenances associated with Crossings unless a separate agreement applies. Those responsibilities are:

- The Railroad is responsible for the maintenance of all Railroad passive and active warning devices within the Railroad ROW.
- If the Railroad has a property interest in the ROW, the Railroad is responsible for the maintenance of Crossing material within the Railroad ROW and two feet beyond each outside rail for Crossings without concrete crossing panels or edge of concrete crossing panel.
- On a temporary Highway detour Crossing, the Railroad shall be responsible for the maintenance of pavement, and passive and active warning devices within the Railroad ROW at expense of the Highway Authority.
- When the Railroad alters the railway due to track and ballast maintenance, the Railroad shall coordinate their work with the Highway Authority so the pavement approaches can be adjusted to provide a smooth and level Crossing surface.
- When the Highway Authority changes the Highway profile, through construction or maintenance activities, the Highway Authority shall coordinate their work with the Railroad so the tracks can be adjusted to provide as smooth and level a Crossing surface as possible.
- Where a Highway structure overpasses a Railroad, the Highway Authority is responsible for the maintenance of the entire structure and its approaches.
- Where a Highway underpasses a Railroad and the Railroad owns the ROW in fee title, the Highway Authority is responsible for the maintenance of the Highway and the entire structure below and including the deck plate, girders, handrail, and parapets. The Railroad is responsible for the maintenance of the ballast, ties, rails and any portion of the supporting structure above the top of the ballast deck plate between parapets.
- If the Highway Authority owns the ROW in fee title, the Railroad is responsible for the maintenance of the entire structure unless a separate agreement applies.
 - Cost of repairing damages to a Highway or a Highway structure, occasioned by collision, equipment failure, or derailment of the Railroads equipment shall be borne by the Railroad.
- Responsibility for maintenance of private industrial trackage not owned by a Railroad that crosses a Highway shall be as follows:
 - When a facility, plant, or property owner receives goods and services from a Railroad over private industrial trackage that crosses a Highway, maintenance of the Crossing shall be the responsibility of the industry owning the trackage, or as agreed to by the parties.
 - When the Crossing becomes a safety hazard to vehicles and is not maintained, UDOT and/or the Railroad shipping the goods and services shall notify the industry owning the trackage in writing to maintain or replace the Crossing material.

- If the industry owning the trackage does not maintain or replace the Crossing material by a specified date, UDOT shall order the Railroad to cease operations across the Crossing.
- If the industry owning the trackage does not respond to the order to maintain or replace the Crossing material UDOT shall arrange to have the Crossing material replaced and bill the industry owning the trackage for the expenses to repair the trackage.

Following are the Railroad points of contact for maintenance related issues:

Bill Ince Union Pacific Railroad 801-212-3939 billince@up.com	Todd Provost UTA 801-237-1909 tprovost@rideuta.com	Scott Cox Utah Railway 801-367-1814 scox@gwrr.com
Maurice Bowens Utah Central Railway 801-732-8906 mbowens@ucry.net	Chris Weesner Salt Lake Garfield & Western Railway 801-322-3429 slgwchris@yahoo.com	Craig Lacey Heber Valley Railroad 435-654-5601

8.1. EMERGENCY MANAGEMENT

In the event of an incident at a Railroad crossing, police and emergency officials should be notified immediately if the incident has already or has the potential to pose a risk to the traveling public. Call 911.

List of Railroad emergency contacts to report crossing blockages and unsafe conditions:

<u>AMTRAK</u>	<u>1-800-331-0008</u>
<u>BNSF</u>	<u>1-800-832-5452</u>
<u>Heber Valley Railroad</u>	<u>1-435-654-5601</u>
<u>Salt Lake, Garfield and Western Railway</u>	<u>1-801-322-3429</u>
<u>Union Pacific Railroad</u>	<u>1-888-877-7267</u>
<u>Utah Railway</u>	<u>1-801-233-0666</u>
<u>UTA FrontRunner</u>	<u>1-801-287-5455</u>
<u>UTA TRAX</u>	<u>1-801-352-6700</u>
<u>Savage Bingham and Garfield Railroad</u>	<u>1-801-694-2215</u>

APPENDIX

APPENDIX SECTION 1
FEDERAL DOCUMENTS

6, 1992, 106 Stat. 1550; Pub. L. 105-178, title I, §1207(b), June 9, 1998, 112 Stat. 185, which directed the Secretary to carry out a program for construction of ferry boats and ferry terminal facilities in accordance with section 129(c) of this title, was repealed by Pub. L. 109-59, title I, §1801(c), Aug. 10, 2005, 119 Stat. 1456. See section 147 of this title.

STUDY TO DETERMINE EXTENT OF BONDED INDEBTEDNESS OF STATES FOR CONSTRUCTION OF TOLL ROADS INCORPORATED INTO INTERSTATE SYSTEM

Section 164 of Pub. L. 95-599, as amended by Pub. L. 96-106, §16, Nov. 19, 1979, 93 Stat. 798, directed Secretary of Transportation to report not later than July 1, 1980, respecting extent of outstanding bonded indebtedness for each State as of Jan. 1, 1979, incurred by each State or public authority prior to June 29, 1956, for road construction or portions incorporated within Interstate System, and methods of allocating bonded indebtedness and removal of toll provisions.

RICHMOND-PETERSBURG TURNPIKE

Section 131 of Pub. L. 91-605 provided that: "The Secretary of Transportation is authorized to amend any agreement heretofore entered into under the provisions of section 129(d) of title 23, United States Code, in order to permit the continuation of tolls on the existing Richmond-Petersburg Turnpike to finance the construction within the existing termini of such turnpike of two lanes thereon in addition to the lanes in existence on the date of enactment of this section [Dec. 31, 1970] necessary to meet traffic and highway safety requirements. Any amended agreement entered into for such purposes shall provide assurances that the existing turnpike (including the additional lanes) shall become free to the public upon the collection of tolls sufficient to liquidate all construction costs, and the costs of maintenance, operation, and debt service during the period of toll collections to liquidate such construction costs, but in no event shall tolls be collected after date of maturity of those bonds outstanding on the date of enactment of this section [Dec. 31, 1970] issued for construction of such turnpike having the latest maturity date."

§ 130. Railway-highway crossings

(a) Subject to section 120 and subsection (b) of this section, the entire cost of construction of projects for the elimination of hazards of railway-highway crossings, including the separation or protection of grades at crossings, the reconstruction of existing railroad grade crossing structures, and the relocation of highways to eliminate grade crossings, may be paid from sums apportioned in accordance with section 104 of this title. In any case when the elimination of the hazards of a railway-highway crossing can be effected by the relocation of a portion of a railway at a cost estimated by the Secretary to be less than the cost of such elimination by one of the methods mentioned in the first sentence of this section, then the entire cost of such relocation project, subject to section 120 and subsection (b) of this section, may be paid from sums apportioned in accordance with section 104 of this title.

(b) The Secretary may classify the various types of projects involved in the elimination of hazards of railway-highway crossings, and may set for each such classification a percentage of the costs of construction which shall be deemed to represent the net benefit to the railroad or railroads for the purpose of determining the railroad's share of the cost of construction. The percentage so determined shall in no case exceed

10 per centum. The Secretary shall determine the appropriate classification of each project.

(c) Any railroad involved in a project for the elimination of hazards of railway-highway crossings paid for in whole or in part from sums made available for expenditure under this title, or prior Acts, shall be liable to the United States for the net benefit to the railroad determined under the classification of such project made pursuant to subsection (b) of this section. Such liability to the United States may be discharged by direct payment to the State transportation department of the State in which the project is located, in which case such payment shall be credited to the cost of the project. Such payment may consist in whole or in part of materials and labor furnished by the railroad in connection with the construction of such project. If any such railroad fails to discharge such liability within a six-month period after completion of the project, it shall be liable to the United States for its share of the cost, and the Secretary shall request the Attorney General to institute proceedings against such railroad for the recovery of the amount for which it is liable under this subsection. The Attorney General is authorized to bring such proceedings on behalf of the United States, in the appropriate district court of the United States, and the United States shall be entitled in such proceedings to recover such sums as it is considered and adjudged by the court that such railroad is liable for in the premises. Any amounts recovered by the United States under this subsection shall be credited to miscellaneous receipts.

(d) SURVEY AND SCHEDULE OF PROJECTS.—Each State shall conduct and systematically maintain a survey of all highways to identify those railroad crossings which may require separation, relocation, or protective devices, and establish and implement a schedule of projects for this purpose. At a minimum, such a schedule shall provide signs for all railway-highway crossings.

(e) FUNDS FOR PROTECTIVE DEVICES.—

(1) IN GENERAL.—Before making an apportionment under section 104(b)(5) for a fiscal year, the Secretary shall set aside, from amounts made available to carry out the highway safety improvement program under section 148 for such fiscal year, at least \$220,000,000 for the elimination of hazards and the installation of protective devices at railway-highway crossings. At least ½ of the funds authorized for and expended under this section shall be available for the installation of protective devices at railway-highway crossings. Sums authorized to be appropriated to carry out this section shall be available for obligation in the same manner as funds apportioned under section 104(b)(1) of this title.

(2) SPECIAL RULE.—If a State demonstrates to the satisfaction of the Secretary that the State has met all its needs for installation of protective devices at railway-highway crossings, the State may use funds made available by this section for other purposes under this subsection.

(f) APPORTIONMENT.—

(1) FORMULA.—Fifty percent of the funds set aside to carry out this section pursuant to

subsection (e)(1) shall be apportioned to the States in accordance with the formula set forth in section 104(b)(3)(A), and 50 percent of such funds shall be apportioned to the States in the ratio that total public railway-highway crossings in each State bears to the total of such crossings in all States.

(2) MINIMUM APPORTIONMENT.—Notwithstanding paragraph (1), each State shall receive a minimum of one-half of 1 percent of the funds apportioned under paragraph (1).

(3) FEDERAL SHARE.—The Federal share payable on account of any project financed with funds set aside to carry out this section shall be 90 percent of the cost thereof.

(g) ANNUAL REPORT.—Each State shall report to the Secretary not later than December 30 of each year on the progress being made to implement the railway-highway crossings program authorized by this section and the effectiveness of such improvements. Each State report shall contain an assessment of the costs of the various treatments employed and subsequent accident experience at improved locations. The Secretary shall submit a report to the Committee on Environment and Public Works and the Committee on Commerce, Science, and Transportation,¹ of the Senate and the Committee on Transportation and Infrastructure of the House of Representatives, not later than April 1, 2006, and every 2 years thereafter,¹ on the progress being made by the State in implementing projects to improve railway-highway crossings. The report shall include, but not be limited to, the number of projects undertaken, their distribution by cost range, road system, nature of treatment, and subsequent accident experience at improved locations. In addition, the Secretary's report shall analyze and evaluate each State program, identify any State found not to be in compliance with the schedule of improvements required by subsection (d) and include recommendations for future implementation of the railroad highway² crossings program.

(h) USE OF FUNDS FOR MATCHING.—Funds authorized to be appropriated to carry out this section may be used to provide a local government with funds to be used on a matching basis when State funds are available which may only be spent when the local government produces matching funds for the improvement of railway-highway crossings.

(i) INCENTIVE PAYMENTS FOR AT-GRADE CROSSING CLOSURES.—

(1) IN GENERAL.—Notwithstanding any other provision of this section and subject to paragraphs (2) and (3), a State may, from sums available to the State under this section, make incentive payments to local governments in the State upon the permanent closure by such governments of public at-grade railway-highway crossings under the jurisdiction of such governments.

(2) INCENTIVE PAYMENTS BY RAILROADS.—A State may not make an incentive payment under paragraph (1) to a local government with respect to the closure of a crossing unless the railroad owning the tracks on which the

crossing is located makes an incentive payment to the government with respect to the closure.

(3) AMOUNT OF STATE PAYMENT.—The amount of the incentive payment payable to a local government by a State under paragraph (1) with respect to a crossing may not exceed the lesser of—

(A) the amount of the incentive payment paid to the government with respect to the crossing by the railroad concerned under paragraph (2); or

(B) \$7,500.

(4) USE OF STATE PAYMENTS.—A local government receiving an incentive payment from a State under paragraph (1) shall use the amount of the incentive payment for transportation safety improvements.

(j) BICYCLE SAFETY.—In carrying out projects under this section, a State shall take into account bicycle safety.

(k) EXPENDITURE OF FUNDS.—Not more than 2 percent of funds apportioned to a State to carry out this section may be used by the State for compilation and analysis of data in support of activities carried out under subsection (g).

(Pub. L. 85-767, Aug. 27, 1958, 72 Stat. 903; Pub. L. 100-17, title I, §121(a), Apr. 2, 1987, 101 Stat. 159; Pub. L. 104-59, title III, §325(a), Nov. 28, 1995, 109 Stat. 591; Pub. L. 104-205, title III, §353(b), Sept. 30, 1996, 110 Stat. 2980; Pub. L. 105-178, title I, §§1111(d), 1202(d), 1212(a)(2)(A)(i), June 9, 1998, 112 Stat. 146, 170, 193; Pub. L. 109-59, title I, §1401(d), Aug. 10, 2005, 119 Stat. 1226.)

AMENDMENTS

2005—Subsec. (e). Pub. L. 109-59, §1401(d)(1), designated existing provisions as par. (1), inserted after par. designation "IN GENERAL.—Before making an apportionment under section 104(b)(5) for a fiscal year, the Secretary shall set aside, from amounts made available to carry out the highway safety improvement program under section 148 for such fiscal year, at least \$220,000,000 for the elimination of hazards and the installation of protective devices at railway-highway crossings.", and added par. (2).

Subsec. (f). Pub. L. 109-59, §1401(d)(2), reenacted heading without change and amended text of subsec. (f) generally. Prior to amendment, text read as follows: "Twenty-five percent of the funds authorized to be appropriated to carry out this section shall be apportioned to the States in the same manner as sums are apportioned under section 104(b)(2) of this title, 25 percent of such funds shall be apportioned to the States in the same manner as sums are apportioned under section 104(b)(6) of this title, and 50 percent of such funds shall be apportioned to the States in the ratio that total railway-highway crossings in each State bears to the total of such crossings in all States. The Federal share payable on account of any project financed with funds authorized to be appropriated to carry out this section shall be 90 percent of the cost thereof."

Subsec. (g). Pub. L. 109-59, §1401(d)(3), in third sentence inserted "and the Committee on Commerce, Science, and Transportation," after "Public Works" and substituted " , not later than April 1, 2006, and every 2 years thereafter," for "not later than April 1 of each year".

Subsec. (k). Pub. L. 109-59, §1401(d)(4), added subsec. (k).

1998—Subsec. (a). Pub. L. 105-178, §1111(d), substituted "Subject to section 120" for "Except as provided in subsection (d) of section 120 of this title" in first sentence and "subject to section 120" for "except as provided in

¹ So in original.

² So in original. Probably should be "railroad-highway".

subsection (d) of section 120 of this title” in second sentence.

Subsec. (c). Pub. L. 105-178, §1212(a)(2)(A)(i), substituted “State transportation department” for “State highway department”.

Subsec. (j). Pub. L. 105-178, §1202(d), added subsec. (j). 1996—Subsec. (i). Pub. L. 104-205 added subsec. (i).

1995—Subsec. (g). Pub. L. 104-59 substituted “Committee on Transportation and Infrastructure” for “Committee on Public Works and Transportation” in third sentence.

1987—Subsecs. (d) to (h). Pub. L. 100-17 added subsecs. (d) to (h).

FEDERAL SHARE OF COSTS FOR CONSTRUCTION TO ELIMINATE HAZARDS

Pub. L. 106-246, div. B, title II, §2604, July 13, 2000, 114 Stat. 559, provided that: “Notwithstanding any other provision of law, hereafter, funds apportioned under section 104(b)(3) of title 23 which are applied to projects involving the elimination of hazards of railway-highway crossings, including the separation or protection of grades at crossings, the reconstruction of existing railroad grade crossing structures, and the relocation of highways to eliminate grade crossings, may have a Federal share up to 100 percent of the cost of construction.”

FEDERAL-STATE COOPERATION

Section 351(b), (c) of Pub. L. 104-59 provided that:

“(b) SAFETY ENFORCEMENT.—

“(1) COOPERATION BETWEEN FEDERAL AND STATE AGENCIES.—The National Highway Traffic Safety Administration and the Office of Motor Carriers within the Federal Highway Administration shall cooperate and work, on a continuing basis, with the National Association of Governors’ Highway Safety Representatives, the Commercial Vehicle Safety Alliance, and Operation Lifesaver, Inc., to improve compliance with and enforcement of laws and regulations pertaining to railroad-highway grade crossings.

“(2) REPORT.—Not later than June 1, 1998, the Secretary shall submit to Congress a report indicating—

“(A) how the Department of Transportation worked with the entities referred to in paragraph (1) to improve the awareness of the highway and commercial vehicle safety and law enforcement communities of regulations and safety challenges at railroad-highway grade crossings; and

“(B) how resources are being allocated to better address these challenges and enforce such regulations.

“(c) FEDERAL-STATE PARTNERSHIP.—

“(1) STATEMENT OF POLICY.—

“(A) HAZARDS TO SAFETY.—Certain railroad-highway grade crossings present inherent hazards to the safety of railroad operations and to the safety of persons using those crossings. It is in the public interest—

“(i) to promote grade crossing safety and reduce risk at high risk railroad-highway grade crossings; and

“(ii) to reduce the number of grade crossings while maintaining the reasonable mobility of the American people and their property, including emergency access.

“(B) EFFECTIVE PROGRAMS.—Effective programs to reduce the number of unneeded and unsafe railroad-highway grade crossings require the partnership of Federal, State, and local officials and agencies, and affected railroads.

“(C) HIGHWAY PLANNING.—Promotion of a balanced national transportation system requires that highway planning specifically take into consideration grade crossing safety.

“(2) PARTNERSHIP AND OVERSIGHT.—The Secretary shall encourage each State to make progress toward achievement of the purposes of this subsection.”

VEHICLE PROXIMITY ALERT SYSTEM

Pub. L. 102-240, title I, §1072, Dec. 18, 1991, 105 Stat. 2012, provided that: “The Secretary shall coordinate

the field testing of the vehicle proximity alert system and comparable systems to determine their feasibility for use by priority vehicles as an effective railroad-highway grade crossing safety device. In the event the vehicle proximity alert or a comparable system proves to be technologically and economically feasible, the Secretary shall develop and implement appropriate programs under section 130 of title 23, United States Code, to provide for installation of such devices where appropriate.”

RAILWAY-HIGHWAY CROSSING HAZARDS; NATIONAL HIGHWAY INFORMATION PROGRAM FUNDING

Pub. L. 100-457, title III, §324, Sept. 30, 1988, 102 Stat. 2150, provided that: “Notwithstanding any other provision of law, the Secretary shall make available \$250,000 per year for a national public information program to educate the public of the inherent hazard at railway-highway crossings. Such funds shall be made available out of funds authorized to be appropriated out of the Highway Trust Fund, pursuant to section 130 of title 23, United States Code.”

Similar provisions were contained in the following prior appropriation act:

Pub. L. 100-202, §101(l) [title III, §339], Dec. 22, 1987, 101 Stat. 1329-358, 1329-386.

RAILROAD-HIGHWAY CROSSINGS STUDY AND REPORT

Section 159 of Pub. L. 100-17 directed Secretary of Transportation to conduct a study of national highway-railroad crossing improvement and maintenance needs, with Secretary to consult with State highway administrations, the Association of American Railroads, highway safety groups, and any other appropriate entities in carrying out this study, and directed Secretary, not later than 24 months after Apr. 2, 1987, to submit a final report to Congress on results of the study along with recommendations of how crossing needs can be addressed in a cost effective manner.

STUDY AND INVESTIGATION OF ALLEVIATION OF ENVIRONMENTAL, SOCIAL, ETC., IMPACTS OF INCREASED UNIT TRAIN TRAFFIC

Pub. L. 95-599, title I, §162, Nov. 6, 1978, 92 Stat. 2720, authorized Secretary of Transportation, in cooperation with State highway departments and appropriate officials of local government, to undertake a comprehensive investigation and study of techniques for alleviating the environmental, social, economic, and developmental impacts of increased unit train traffic to meet national energy requirements in communities located along rail corridors experiencing such increased traffic and directed Secretary to report to Congress on results of such investigation and study not later than Mar. 31, 1979.

DEMONSTRATION PROJECT, RAILROAD-HIGHWAY CROSSINGS; REPORTS TO PRESIDENT AND CONGRESS; APPROPRIATIONS AUTHORIZATION; HIGHWAY SAFETY STUDY, REPORT TO CONGRESS

Pub. L. 93-87, title I, §163, Aug. 13, 1973, 87 Stat. 280, as amended by Pub. L. 93-643, §104, Jan. 4, 1975, 88 Stat. 2282; Pub. L. 94-280, title I, §140(a)-(e), May 5, 1976, 90 Stat. 444; Pub. L. 95-599, title I, §134(a)-(c), Nov. 6, 1978, 92 Stat. 2709; Pub. L. 96-470, title II, §209(b), Oct. 19, 1980, 94 Stat. 2245; Pub. L. 97-424, title I, §151, Jan. 6, 1983, 96 Stat. 2132; Pub. L. 100-17, title I, §§133(c)(3), 148, Apr. 2, 1987, 101 Stat. 172, 181; Pub. L. 100-202, §101(l) [title III, §346], Dec. 22, 1987, 101 Stat. 1329-358, 1329-388; Pub. L. 102-240, title I, §1037, Dec. 18, 1991, 105 Stat. 1987; Pub. L. 104-66, title I, §1121(e), Dec. 21, 1995, 109 Stat. 724, provided that:

“(a)(1) The Secretary of Transportation shall enter into such arrangements as may be necessary to carry out demonstration projects in Lincoln, Nebraska, Wheeling, West Virginia, and Elko, Nevada, for the relocation of railroad lines from the central area of the cities in conformance with the methodology developed under proposals submitted to the Secretary by the re-

spective cities. The cities shall (1) have a local agency with legal authority to relocate railroad facilities, levy taxes for such purpose, and a record of prior accomplishment; and (2) have a current relocation plan for such lines which has a favorable benefit-cost ratio involving and having the unanimous approval of three or more class 1 railroads in Lincoln, Nebraska, and the two class 1 railroads in Wheeling, West Virginia, and Elko, Nevada, and multicivic, local, and State agencies, and which provides for the elimination of a substantial number of the existing railway-road conflict points within the city.

“(2) The Secretary of Transportation shall enter into such arrangements as may be necessary to carry out a demonstration project in Lafayette, Indiana, for relocation of railroad lines from the central area of the city. There are authorized to be appropriated to carry out this paragraph \$360,000 for the fiscal year ending June 30, 1975.

“(b) The Secretary of Transportation shall carry out a demonstration project for the elimination or protection of certain public ground-level rail-highway crossings in, or in the vicinity of, Springfield, Illinois.

“(c) The Secretary of Transportation shall enter into such arrangements as may be necessary to carry out demonstration projects in Brownsville, Texas, and Matamoros, Mexico, for the relocation of railroad lines from the central area of the cities in conformance with the methodology developed under proposals submitted to the Secretary by the Brownsville Navigation District, providing for the construction of an international bridge and for the elimination of a substantial number of existing railway-road conflict points within the cities.

“(d) The Secretary of Transportation shall enter into such arrangements as may be necessary to carry out a demonstration project in East Saint Louis, Illinois, for the relocation of rail lines between Thirteenth and Forty-third Streets, in accordance with methodology approved by the Secretary. The Secretary of Transportation shall carry out a demonstration project for the relocation of rail lines in the vicinity of Carbondale, Illinois.

“(e) The Secretary of Transportation shall enter into such arrangements as may be necessary to carry out a demonstration project in New Albany, Indiana, for the elimination of the existing rail loop and relocation of rail lines to a location between Vincennes Street and East Eighth Street, in accordance with methodology approved by the Secretary.

“(f) The Secretary of Transportation shall carry out demonstration projects for the construction of an overpass at the rail-highway grade crossing on Cottage Grove Avenue between One Hundred Forty-second Street and One Hundred Thirty-eighth Street in the village of Dolton, Illinois, and the construction of an overpass at the rail-highway grade crossing at Vermont Street and the Rock Island Railroad tracks in the city of Blue Island, Illinois.

“(g) The Secretary of Transportation shall carry out a demonstration project for the elimination of the ground level railroad highway crossing on United States Route 69 in Greenville, Texas.

“(h) The Secretary of Transportation shall carry out a demonstration project in Anoka, Minnesota, for the construction of an underpass at the Seventh Avenue and County Road 7 railroad-highway grade crossing.

“(i) The Secretary of Transportation shall carry out a demonstration project in Metairie, Jefferson Parish, Louisiana, for the relocation or grade separation of rail lines whichever he deems most feasible in order to eliminate certain grade level railroad highway crossings.

“(j) The Secretary of Transportation shall enter into such arrangements as may be necessary to carry out a demonstration project in Augusta, Georgia, for the relocation of railroad lines and for the purpose of eliminating highway railroad grade crossings.

“(k) The Secretary of Transportation shall enter into such arrangements as may be necessary to carry out a

demonstration project in Pine Bluff, Arkansas, for the relocation of railroad lines for the purpose of eliminating highway railroad grade crossings.

“(l) The Secretary of Transportation shall carry out a demonstration project in Sherman, Texas, for the relocation of rail lines in order to eliminate the ground level railroad crossing at the crossing of the Southern Pacific and Frisco Railroads with Grand Avenue-Roberts Road.

“(m) The Secretary of Transportation shall enter into such arrangements as may be necessary to carry out a demonstration project in Hammond, Indiana, for the relocation of railroad lines for the purposes of eliminating highway railroad grade crossings.

“(n) The Federal share payable on account of such projects shall be the Federal share provided in section 120(a) of title 23, United States Code. [sic] except those railroad-highway crossings segments which are already engaged in or have completed the preparation of the plans, specifications and estimates (PS&E) for the construction of the segment involved shall retain the Federal share as specified in subsection [sic] 163(n) [this subsection] as amended by section 134 of the Surface Transportation Assistance Act of 1978 [section 134 of Pub. L. 95-599].

“(o) Repealed. Pub. L. 104-66, title I, §1121(e), Dec. 21, 1995, 109 Stat. 724.]

“(p) There is authorized to be appropriated to carry out this section (other than subsection (l)), not to exceed \$15,000,000 for the fiscal year ending June 30, 1974, \$25,000,000 for the fiscal year ending June 30, 1975, and \$50,000,000 for the fiscal year ending June 30, 1976, \$6,250,000, for the period beginning July 1, 1976, and ending September 30, 1976, \$26,400,000 for the fiscal year ending September 30, 1977, and \$51,400,000 for the fiscal year ending September 30, 1978, \$70,000,000 for the fiscal year ending September 30, 1979, and \$90,000,000 for the fiscal year ending September 30, 1980, \$100,000,000 for the fiscal year ending September 30, 1981, and \$100,000,000 for the fiscal year ending September 30, 1982, and \$50,000,000 for the fiscal year ending September 30, 1983, and \$50,000,000 for the fiscal year ending September 30, 1984, and \$50,000,000 for the fiscal year ending September 30, 1985, and \$50,000,000 for the fiscal year ending September 30, 1986, and \$15,000,000 per fiscal year for each of fiscal years 1987, 1988, 1989, 1990, 1991, 1992, 1993, and 1994, except that not more than two-thirds of all funds authorized and expended under authority of this section in any fiscal year shall be appropriated out of the Highway Trust fund. Notwithstanding any other provision of this section, any project which is not under construction, according to the Secretary of Transportation, by September 30, 1985, shall not be eligible for additional funds under this authorization.

“(q) The Secretary, in cooperation with State highway departments and local officials, shall conduct a full and complete investigation and study of the problem of providing increased highway safety by the relocation of railroad lines from the central area of cities on a nationwide basis, and report to the Congress his recommendations resulting from such investigation and study not later than July 1, 1975, including an estimate of the cost of such a program. Funds authorized to carry out section 307 of title 23, United States Code, are authorized to be used to carry out the investigation and study required by this subsection.”

DEMONSTRATION PROJECT, RAILROAD-HIGHWAY CROSSINGS; INCLUSION OF PROJECTS AT TERRE HAUTE, INDIANA

Pub. L. 94-387, title I, §101, Aug. 14, 1976, 90 Stat. 1176, provided in part: “That section 163 of Public Law 93-87 [set out as a note above] is hereby amended to include projects at Terre Haute, Indiana.”

RAILROAD-HIGHWAY CROSSINGS

Pub. L. 93-87, title II, §203, Aug. 13, 1973, 87 Stat. 283, as amended by Pub. L. 94-280, title II, §203, May 5, 1976,

90 Stat. 452; Pub. L. 95-599, title II, §203, Nov. 6, 1978, 92 Stat. 2728; Pub. L. 96-470, title II, §209(d), Oct. 19, 1980, 94 Stat. 2245; Pub. L. 97-327, §5(b), Oct. 15, 1982, 96 Stat. 1612; Pub. L. 97-424, title II, §205, Jan. 6, 1983, 96 Stat. 2139, which directed each State to conduct a survey of all highways to identify those railway crossings requiring separation, relocation, or protective devices and to establish and implement a schedule of projects for such purpose, which at a minimum was to provide for signs at all crossings, authorized appropriations for elimination of hazards of railway-highway crossings, provided for State apportionments and for the Federal share of the costs of projects, required each State to annually report to the Secretary of Transportation and the Secretary of Transportation to annually report to Congress on progress in implementing railroad-highway crossings program, and authorized use of matching funds with local governments for improvement of railroad crossings, was repealed by Pub. L. 100-17, title I, §121(b), Apr. 2, 1987, 101 Stat. 160.

Highway authorizations provisions of section 104(a) (1) and (2) of Pub. L. 93-87, referred to in section 203(d) of Pub. L. 93-87 provided that:

“(a) For the purpose of carrying out the provisions of title 23, United States Code, the following sums are hereby authorized to be appropriated:

“(1) For the Federal-aid primary system in rural areas, out of the Highway Trust Fund, \$680,000,000 for the fiscal year ending June 30, 1974, \$700,000,000 for the fiscal year ending June 30, 1975, and \$700,000,000 for the fiscal year ending June 30, 1976. For the Federal-aid secondary system in rural areas, out of Highway Trust Fund, \$390,000,000 for the fiscal year ending June 30, 1974, \$400,000,000 for the fiscal year ending June 30, 1975, and \$400,000,000 for the fiscal year ending June 30, 1976.

“(2) For the Federal-aid urban system, out of the Highway Trust Fund, \$780,000,000 for the fiscal year ending June 30, 1974, \$800,000,000 for the fiscal year ending June 30, 1975, and \$800,000,000 for the fiscal year ending June 30, 1976. For the extensions of the Federal-aid primary and secondary systems in urban areas, out of the Highway Trust Fund \$290,000,000 for the fiscal year ending June 30, 1974, \$300,000,000 for the fiscal year ending June 30, 1975, and \$300,000,000 for the fiscal year ending June 30, 1976.”

§ 131. Control of outdoor advertising

(a) The Congress hereby finds and declares that the erection and maintenance of outdoor advertising signs, displays, and devices in areas adjacent to the Interstate System and the primary system should be controlled in order to protect the public investment in such highways, to promote the safety and recreational value of public travel, and to preserve natural beauty.

(b) Federal-aid highway funds apportioned on or after January 1, 1968, to any State which the Secretary determines has not made provision for effective control of the erection and maintenance along the Interstate System and the primary system of outdoor advertising signs, displays, and devices which are within six hundred and sixty feet of the nearest edge of the right-of-way and visible from the main traveled way of the system, and Federal-aid highway funds apportioned on or after January 1, 1975, or after the expiration of the next regular session of the State legislature, whichever is later, to any State which the Secretary determines has not made provision for effective control of the erection and maintenance along the Interstate System and the primary system of those additional outdoor advertising signs, displays, and devices which are more than six hundred and sixty feet off the nearest edge of the right-of-way, located outside of urban areas, visible from the main

traveled way of the system, and erected with the purpose of their message being read from such main traveled way, shall be reduced by amounts equal to 10 per centum of the amounts which would otherwise be apportioned to such State under section 104 of this title, until such time as such State shall provide for such effective control. Any amount which is withheld from apportionment to any State hereunder shall be re-apportioned to the other States. Whenever he determines it to be in the public interest, the Secretary may suspend, for such periods as he deems necessary, the application of this subsection to a State.

(c) Effective control means that such signs, displays, or devices after January 1, 1968, if located within six hundred and sixty feet of the right-of-way and, on or after July 1, 1975, or after the expiration of the next regular session of the State legislature, whichever is later, if located beyond six hundred and sixty feet of the right-of-way located outside of urban areas, visible from the main traveled way of the system, and erected with the purpose of their message being read from such main traveled way, shall, pursuant to this section, be limited to (1) directional and official signs and notices, which signs and notices shall include, but not be limited to, signs and notices pertaining to natural wonders, scenic and historical attractions, which are required or authorized by law, which shall conform to national standards hereby authorized to be promulgated by the Secretary hereunder, which standards shall contain provisions concerning lighting, size, number, and spacing of signs, and such other requirements as may be appropriate to implement this section, (2) signs, displays, and devices advertising the sale or lease of property upon which they are located, (3) signs, displays, and devices, including those which may be changed at reasonable intervals by electronic process or by remote control, advertising activities conducted on the property on which they are located, (4) signs lawfully in existence on October 22, 1965, determined by the State, subject to the approval of the Secretary, to be landmark signs, including signs on farm structures or natural surfaces, or historic or artistic significance the preservation of which would be consistent with the purposes of this section, and (5) signs, displays, and devices advertising the distribution by nonprofit organizations of free coffee to individuals traveling on the Interstate System or the primary system. For the purposes of this subsection, the term “free coffee” shall include coffee for which a donation may be made, but is not required.

(d) In order to promote the reasonable, orderly and effective display of outdoor advertising while remaining consistent with the purposes of this section, signs, displays, and devices whose size, lighting and spacing, consistent with customary use is to be determined by agreement between the several States and the Secretary, may be erected and maintained within six hundred and sixty feet of the nearest edge of the right-of-way within areas adjacent to the Interstate and primary systems which are zoned industrial or commercial under authority of State law, or in unzoned commercial or industrial areas as may be determined by agreement be-

System, other than provisions relating to apportionment formula and Federal share, shall apply to funds made available to carry out this section, except as determined by the Secretary to be inconsistent with this section.

(Added Pub. L. 93-87, title I, §126(a), Aug. 13, 1973, 87 Stat. 263; amended Pub. L. 94-280, title I, §130, May 5, 1976, 90 Stat. 440; Pub. L. 105-178, title I, §1212(a)(2)(A)(i), June 9, 1998, 112 Stat. 193; Pub. L. 109-59, title I, §1801(a), Aug. 10, 2005, 119 Stat. 1455.)

AMENDMENTS

2005—Pub. L. 109-59 amended section catchline and text generally, substituting provisions relating to program for construction of ferry boats and ferry terminal facilities for provisions relating to selection of high traffic sections of highways as priority primary routes for priority of improvement to supplement the service provided by the Interstate System by furnishing needed adequate traffic collector and distributor facilities.

1998—Subsec. (a). Pub. L. 105-178 substituted "State transportation department" for "State highway department".

1976—Subsec. (b). Pub. L. 94-280 amended subsec. (b) generally, striking out apportionment provisions.

AUTHORIZATION OF APPROPRIATIONS

Pub. L. 109-59, title I, §1801(d), Aug. 10, 2005, 119 Stat. 1456, provided that: "In addition to amounts made available to carry out section 147 of title 23, United States Code, by section 1101 of this Act [119 Stat. 1153], there are authorized to be appropriated such sums as may be necessary to carry out such section 147 for fiscal year 2006 and each fiscal year thereafter. Such funds shall remain available until expended."

§ 148. Highway safety improvement program

(a) DEFINITIONS.—In this section, the following definitions apply:

(1) HIGH RISK RURAL ROAD.—The term "high risk rural road" means any roadway functionally classified as a rural major or minor collector or a rural local road—

(A) on which the accident rate for fatalities and incapacitating injuries exceeds the statewide average for those functional classes of roadway; or

(B) that will likely have increases in traffic volume that are likely to create an accident rate for fatalities and incapacitating injuries that exceeds the statewide average for those functional classes of roadway.

(2) HIGHWAY SAFETY IMPROVEMENT PROGRAM.—The term "highway safety improvement program" means the program carried out under this section.

(3) HIGHWAY SAFETY IMPROVEMENT PROJECT.—

(A) IN GENERAL.—The term "highway safety improvement project" means a project described in the State strategic highway safety plan that—

(i) corrects or improves a hazardous road location or feature; or

(ii) addresses a highway safety problem.

(B) INCLUSIONS.—The term "highway safety improvement project" includes a project for one or more of the following:

(i) An intersection safety improvement.

(ii) Pavement and shoulder widening (including addition of a passing lane to remedy an unsafe condition).

(iii) Installation of rumble strips or another warning device, if the rumble strips or other warning devices do not adversely affect the safety or mobility of bicyclists, pedestrians, and the disabled.

(iv) Installation of a skid-resistant surface at an intersection or other location with a high frequency of accidents.

(v) An improvement for pedestrian or bicyclist safety or safety of the disabled.

(vi) Construction of any project for the elimination of hazards at a railway-highway crossing that is eligible for funding under section 130, including the separation or protection of grades at railway-highway crossings.

(vii) Construction of a railway-highway crossing safety feature, including installation of protective devices.

(viii) The conduct of a model traffic enforcement activity at a railway-highway crossing.

(ix) Construction of a traffic calming feature.

(x) Elimination of a roadside obstacle.

(xi) Improvement of highway signage and pavement markings.

(xii) Installation of a priority control system for emergency vehicles at signalized intersections.

(xiii) Installation of a traffic control or other warning device at a location with high accident potential.

(xiv) Safety-conscious planning.

(xv) Improvement in the collection and analysis of crash data.

(xvi) Planning integrated interoperable emergency communications equipment, operational activities, or traffic enforcement activities (including police assistance) relating to workzone safety.

(xvii) Installation of guardrails, barriers (including barriers between construction work zones and traffic lanes for the safety of motorists and workers), and crash attenuators.

(xviii) The addition or retrofitting of structures or other measures to eliminate or reduce accidents involving vehicles and wildlife.

(xix) Installation and maintenance of signs (including fluorescent, yellow-green signs) at pedestrian-bicycle crossings and in school zones.

(xx) Construction and yellow-green signs at pedestrian-bicycle crossings and in school zones.

(xxi) Construction and operational improvements on high risk rural roads.

(4) SAFETY PROJECT UNDER ANY OTHER SECTION.—

(A) IN GENERAL.—The term "safety project under any other section" means a project carried out for the purpose of safety under any other section of this title.

(B) INCLUSION.—The term "safety project under any other section" includes a project to promote the awareness of the public and educate the public concerning highway safety matters (including motorcyclist safety) and a project to enforce highway safety laws.

(5) STATE HIGHWAY SAFETY IMPROVEMENT PROGRAM.—The term “State highway safety improvement program” means projects or strategies included in the State strategic highway safety plan carried out as part of the State transportation improvement program under section 135(g).

(6) STATE STRATEGIC HIGHWAY SAFETY PLAN.—The term “State strategic highway safety plan” means a plan developed by the State transportation department that—

(A) is developed after consultation with—

(i) a highway safety representative of the Governor of the State;

(ii) regional transportation planning organizations and metropolitan planning organizations, if any;

(iii) representatives of major modes of transportation;

(iv) State and local traffic enforcement officials;

(v) persons responsible for administering section 130 at the State level;

(vi) representatives conducting Operation Lifesaver;

(vii) representatives conducting a motor carrier safety program under section 31102, 31106, or 31309 of title 49;

(viii) motor vehicle administration agencies; and

(ix) other major State and local safety stakeholders;

(B) analyzes and makes effective use of State, regional, or local crash data;

(C) addresses engineering, management, operation, education, enforcement, and emergency services elements (including integrated, interoperable emergency communications) of highway safety as key factors in evaluating highway projects;

(D) considers safety needs of, and high-fatality segments of, public roads;

(E) considers the results of State, regional, or local transportation and highway safety planning processes;

(F) describes a program of projects or strategies to reduce or eliminate safety hazards;

(G) is approved by the Governor of the State or a responsible State agency; and

(H) is consistent with the requirements of section 135(g).

(b) PROGRAM.—

(1) IN GENERAL.—The Secretary shall carry out a highway safety improvement program.

(2) PURPOSE.—The purpose of the highway safety improvement program shall be to achieve a significant reduction in traffic fatalities and serious injuries on public roads.

(c) ELIGIBILITY.—

(1) IN GENERAL.—To obligate funds apportioned under section 104(b)(5) to carry out this section, a State shall have in effect a State highway safety improvement program under which the State—

(A) develops and implements a State strategic highway safety plan that identifies and analyzes highway safety problems and opportunities as provided in paragraph (2);

(B) produces a program of projects or strategies to reduce identified safety problems;

(C) evaluates the plan on a regular basis to ensure the accuracy of the data and priority of proposed improvements; and

(D) submits to the Secretary an annual report that—

(i) describes, in a clearly understandable fashion, not less than 5 percent of locations determined by the State, using criteria established in accordance with paragraph (2)(B)(ii), as exhibiting the most severe safety needs; and

(ii) contains an assessment of—

(I) potential remedies to hazardous locations identified;

(II) estimated costs associated with those remedies; and

(III) impediments to implementation other than cost associated with those remedies.

(2) IDENTIFICATION AND ANALYSIS OF HIGHWAY SAFETY PROBLEMS AND OPPORTUNITIES.—As part of the State strategic highway safety plan, a State shall—

(A) have in place a crash data system with the ability to perform safety problem identification and countermeasure analysis;

(B) based on the analysis required by subparagraph (A)—

(i) identify hazardous locations, sections, and elements (including roadside obstacles, railway-highway crossing needs, and unmarked or poorly marked roads) that constitute a danger to motorists (including motorcyclists), bicyclists, pedestrians, and other highway users; and

(ii) using such criteria as the State determines to be appropriate, establish the relative severity of those locations, in terms of accidents, injuries, deaths, traffic volume levels, and other relevant data;

(C) adopt strategic and performance-based goals that—

(i) address traffic safety, including behavioral and infrastructure problems and opportunities on all public roads;

(ii) focus resources on areas of greatest need; and

(iii) are coordinated with other State highway safety programs;

(D) advance the capabilities of the State for traffic records data collection, analysis, and integration with other sources of safety data (such as road inventories) in a manner that—

(i) complements the State highway safety program under chapter 4 and the commercial vehicle safety plan under section 31102 of title 49;

(ii) includes all public roads;

(iii) identifies hazardous locations, sections, and elements on public roads that constitute a danger to motorists (including motorcyclists), bicyclists, pedestrians, the disabled, and other highway users; and

(iv) includes a means of identifying the relative severity of hazardous locations described in clause (iii) in terms of accidents, injuries, deaths, and traffic volume levels;

(E)(i) determine priorities for the correction of hazardous road locations, sections,

and elements (including railway-highway crossing improvements), as identified through crash data analysis;

(ii) identify opportunities for preventing the development of such hazardous conditions; and

(iii) establish and implement a schedule of highway safety improvement projects for hazard correction and hazard prevention; and

(F)(i) establish an evaluation process to analyze and assess results achieved by highway safety improvement projects carried out in accordance with procedures and criteria established by this section; and

(ii) use the information obtained under clause (i) in setting priorities for highway safety improvement projects.

(d) ELIGIBLE PROJECTS.—

(1) IN GENERAL.—A State may obligate funds apportioned to the State under section 104(b)(5) to carry out—

(A) any highway safety improvement project on any public road or publicly owned bicycle or pedestrian pathway or trail; or

(B) as provided in subsection (e), other safety projects.

(2) USE OF OTHER FUNDING FOR SAFETY.—

(A) EFFECT OF SECTION.—Nothing in this section prohibits the use of funds made available under other provisions of this title for highway safety improvement projects.

(B) USE OF OTHER FUNDS.—States are encouraged to address the full scope of their safety needs and opportunities by using funds made available under other provisions of this title (except a provision that specifically prohibits that use).

(e) FLEXIBLE FUNDING FOR STATES WITH A STRATEGIC HIGHWAY SAFETY PLAN.—

(1) IN GENERAL.—To further the implementation of a State strategic highway safety plan, a State may use up to 10 percent of the amount of funds apportioned to the State under section 104(b)(5) for a fiscal year to carry out safety projects under any other section as provided in the State strategic highway safety plan if the State certifies that—

(A) the State has met needs in the State relating to railway-highway crossings; and

(B) the State has met the State's infrastructure safety needs relating to highway safety improvement projects.

(2) OTHER TRANSPORTATION AND HIGHWAY SAFETY PLANS.—Nothing in this subsection requires a State to revise any State process, plan, or program in effect on the date of enactment of this section.

(f) HIGH RISK RURAL ROADS.—

(1) IN GENERAL.—After making an apportionment under section 104(b)(5) for a fiscal year beginning after September 30, 2005, the Secretary shall ensure, from amounts made available to carry out this section for such fiscal year, that a total of \$90,000,000 of such apportionment is set aside by the States, proportionally according to the share of each State of the total amount so apportioned, for use only for construction and operational improvements on high risk rural roads.

(2) SPECIAL RULE.—A State may use funds apportioned to the State pursuant to this subsection for any project under this section if the State certifies to the Secretary that the State has met all of State needs for construction and operational improvements on high risk rural roads.

(g) REPORTS.—

(1) IN GENERAL.—A State shall submit to the Secretary a report that—

(A) describes progress being made to implement highway safety improvement projects under this section;

(B) assesses the effectiveness of those improvements; and

(C) describes the extent to which the improvements funded under this section contribute to the goals of—

(i) reducing the number of fatalities on roadways;

(ii) reducing the number of roadway-related injuries;

(iii) reducing the occurrences of roadway-related crashes;

(iv) mitigating the consequences of roadway-related crashes; and

(v) reducing the occurrences of crashes at railway-highway crossings.

(2) CONTENTS; SCHEDULE.—The Secretary shall establish the content and schedule for a report under paragraph (1).

(3) TRANSPARENCY.—The Secretary shall make reports submitted under subsection (c)(1)(D) available to the public through—

(A) the Web site of the Department; and

(B) such other means as the Secretary determines to be appropriate.

(4) DISCOVERY AND ADMISSION INTO EVIDENCE OF CERTAIN REPORTS, SURVEYS, AND INFORMATION.—Notwithstanding any other provision of law, reports, surveys, schedules, lists, or data compiled or collected for any purpose directly relating to paragraph (1) or subsection (c)(1)(D), or published by the Secretary in accordance with paragraph (3), shall not be subject to discovery or admitted into evidence in a Federal or State court proceeding or considered for other purposes in any action for damages arising from any occurrence at a location identified or addressed in such reports, surveys, schedules, lists, or other data.

(h) FEDERAL SHARE OF HIGHWAY SAFETY IMPROVEMENT PROJECTS.—Except as provided in sections 120 and 130, the Federal share of the cost of a highway safety improvement project carried out with funds apportioned to a State under section 104(b)(5) shall be 90 percent.

(Added Pub. L. 93-87, title I, §129(b), Aug. 13, 1973, 87 Stat. 265; amended Pub. L. 95-599, title I, §§125, 129(d), Nov. 6, 1978, 92 Stat. 2705, 2707; Pub. L. 109-59, title I, §1401(a)(1), Aug. 10, 2005, 119 Stat. 1219.)

REFERENCES IN TEXT

The date of enactment of this section, referred to in subsec. (e)(2), probably means the date of enactment of Pub. L. 109-59, which amended this section generally and was approved Aug. 10, 2005.

AMENDMENTS

2005—Pub. L. 109-59 amended section catchline and text generally, substituting provisions relating to a

highway safety improvement program for provisions relating to development of the Great River Road, a national scenic and recreational highway.

1978—Subsec. (a)(5). Pub. L. 95-599, §125(b), inserted provision authorizing charging of a fee in certain cases to cover operational costs.

Subsec. (e). Pub. L. 95-599, §129(d), substituted “75 per centum” for “70 per centum”.

Subsec. (h). Pub. L. 95-599, §125(a), added subsec. (h).

EFFECTIVE DATE OF 1978 AMENDMENT

Amendment by section 129(d) of Pub. L. 95-599 effective with respect to obligations incurred after Nov. 6, 1978, see section 129(h) of Pub. L. 95-599, set out as a note under section 120 of this title.

TRANSITION

Pub. L. 109-59, title I, §1401(e), Aug. 10, 2005, 119 Stat. 1227, provided that:

“(1) IMPLEMENTATION.—Except as provided in paragraph (2), the Secretary [of Transportation] shall approve obligations of funds apportioned under section 104(b)(5) of title 23, United States Code (as added by subsection (b)), to carry out section 148 of that title, only if, not later than October 1 of the second fiscal year beginning after the date of enactment of this Act [Aug. 10, 2005], a State has developed and implemented a State strategic highway safety plan as required pursuant to section 148(c) of that title.

“(2) INTERIM PERIOD.—

“(A) IN GENERAL.—Before October 1 of the second fiscal year after the date of enactment of this Act and until the date on which a State develops and implements a State strategic highway safety plan, the Secretary shall apportion funds to a State for the highway safety improvement program and the State may obligate funds apportioned to the State for the highway safety improvement program under section 148 for projects that were eligible for funding under sections 130 and 152 of that title, as in effect on the day before the date of enactment of this Act.

“(B) NO STRATEGIC HIGHWAY SAFETY PLAN.—If a State has not developed a strategic highway safety plan by October 1, 2007, the State shall receive for the highway safety improvement program for each subsequent fiscal year until the date of development of such plan an amount that equals the amount apportioned to the State for that program for fiscal year 2007.”

§ 149. Congestion mitigation and air quality improvement program

(a) ESTABLISHMENT.—The Secretary shall establish and implement a congestion mitigation and air quality improvement program in accordance with this section.

(b) ELIGIBLE PROJECTS.—Except as provided in subsection (c), a State may obligate funds apportioned to it under section 104(b)(2) for the congestion mitigation and air quality improvement program only for a transportation project or program if the project or program is for an area in the State that is or was designated as a nonattainment area for ozone, carbon monoxide, or particulate matter under section 107(d) of the Clean Air Act (42 U.S.C. 7407(d)) and classified pursuant to section 181(a), 186(a), 188(a), or 188(b) of the Clean Air Act (42 U.S.C. 7511(a), 7512(a), 7513(a), or 7513(b)) or is or was designated as a nonattainment area under such section 107(d) after December 31, 1997, or is required to prepare, and file with the Administrator of the Environmental Protection Agency, maintenance plans under the Clean Air Act (42 U.S.C. 7401 et seq.) and—

(1)(A)(i) if the Secretary, after consultation with the Administrator determines, on the

basis of information published by the Environmental Protection Agency pursuant to section 108(f)(1)(A) of the Clean Air Act (other than clause (xvi)) that the project or program is likely to contribute to—

(I) the attainment of a national ambient air quality standard; or

(II) the maintenance of a national ambient air quality standard in a maintenance area; and

(ii) a high level of effectiveness in reducing air pollution, in cases of projects or programs where sufficient information is available in the database established pursuant to subsection (h) to determine the relative effectiveness of such projects or programs; or,

(B) in any case in which such information is not available, if the Secretary, after such consultation, determines that the project or program is part of a program, method, or strategy described in such section 108(f)(1)(A);

(2) if the project or program is included in a State implementation plan that has been approved pursuant to the Clean Air Act and the project will have air quality benefits;

(3) the Secretary, after consultation with the Administrator of the Environmental Protection Agency, determines that the project or program is likely to contribute to the attainment of a national ambient air quality standard, whether through reductions in vehicle miles traveled, fuel consumption, or through other factors;

(4) to establish or operate a traffic monitoring, management, and control facility or program, including advanced truck stop electrification systems, if the Secretary, after consultation with the Administrator of the Environmental Protection Agency, determines that the facility or program is likely to contribute to the attainment of a national ambient air quality standard;

(5) if the program or project improves traffic flow, including projects to improve signalization, construct high occupancy vehicle lanes, improve intersections, improve transportation systems management and operations that mitigate congestion and improve air quality, and implement intelligent transportation system strategies and such other projects that are eligible for assistance under this section on the day before the date of enactment of this paragraph;

(6) if the project or program involves the purchase of integrated, interoperable emergency communications equipment; or

(7) if the project or program is for—

(A) the purchase of diesel retrofits that are—

(i) for motor vehicles (as defined in section 216 of the Clean Air Act (42 U.S.C. 7550)); or

(ii) published in the list under subsection (f)(2) for non-road vehicles and non-road engines (as defined in section 216 of the Clean Air Act (42 U.S.C. 7550)) that are used in construction projects that are—

(I) located in nonattainment or maintenance areas for ozone, PM₁₀, or PM_{2.5} (as defined under the Clean Air Act (42 U.S.C. 7401 et seq.)); and

SUBCHAPTER B—PAYMENT PROCEDURES

PART 140—REIMBURSEMENT

Subpart A [Reserved]

Subpart B—Construction Engineering Costs

Sec.

- 140.201 Purpose.
- 140.203 Policy.
- 140.205 Limitation.
- 140.207 Application of limitation.

Subparts C–D [Reserved]

Subpart E—Administrative Settlement Costs—Contract Claims

- 140.501 Purpose.
- 140.503 Definition.
- 140.505 Reimbursable costs.

Subpart F—Reimbursement for Bond Issue Projects

- 140.601 Purpose.
- 140.602 Requirements and conditions.
- 140.603 Programs.
- 140.604 Reimbursable schedule.
- 140.605 Approval actions.
- 140.606 Project agreements.
- 140.607 Construction.
- 140.608 Reimbursable bond interest costs of Interstate projects.
- 140.609 Progress and final vouchers.
- 140.610 Conversion from bond issue to funded project status.
- 140.611 Determination of bond retirement.
- 140.612 Cash management.

APPENDIX TO SUBPART F—REIMBURSABLE SCHEDULE FOR CONVERTED “E” (BOND ISSUE) PROJECTS (OTHER THAN INTERSTATE PROJECTS)

Subpart G [Reserved]

Subpart H—State Highway Agency Audit Expense

- 140.801 Purpose.
- 140.803 Policy.
- 140.805 Definitions.
- 140.807 Reimbursable costs.

Subpart I—Reimbursement for Railroad Work

- 140.900 Purpose.
- 140.902 Applicability.
- 140.904 Reimbursement basis.
- 140.906 Labor costs.
- 140.907 Overhead and indirect construction costs.
- 140.908 Materials and supplies.

- 140.910 Equipment.
- 140.912 Transportation.
- 140.914 Credits for improvements.
- 140.916 Protection.
- 140.918 Maintenance and extended construction.
- 140.920 Lump sum payments.
- 140.922 Billings.

AUTHORITY: 23 U.S.C. 101(e), 106, 109(e), 114(a), 120(g), 121, 122, 130, and 315; and 49 CFR 1.48(b).

Subpart A [Reserved]

Subpart B—Construction Engineering Costs

SOURCE: 58 FR 39143, July 22, 1993, unless otherwise noted.

§ 140.201 Purpose.

The purpose of this subpart is to prescribe policies for claiming reimbursement for eligible construction engineering (CE) costs.

§ 140.203 Policy.

(a) State highway agencies (SHA) may be reimbursed for the Federal share of CE costs incurred as described in § 140.703.

(b) Reimbursement for CE costs for Federal-aid construction projects shall be subject to the limitation set forth in § 140.205.

§ 140.205 Limitation.

(a) The estimated CE costs for a SHA for a fiscal year shall not exceed, in the aggregate, 15 percent of the total estimated costs of all projects financed within the boundaries of the State with Federal-aid highway funds in such fiscal year, exclusive of the costs of rights-of-way, preliminary engineering, and CE.

(b) For control purposes, a SHA's estimated CE costs percentage will be determined by the ratio of the total amount obligated for CE to the total amount obligated for all projects financed with Federal-aid highway funds during the fiscal year, after excluding from such totals, the obligations for rights-of-way, preliminary engineering,

Federal Highway Administration, DOT

§ 140.601

and CE. This percentage shall not exceed 15 percent at the end of the fiscal year. The CE limitation may be applied on either a Federal or State fiscal year basis.

(1) Amounts to be included in the determination for CE will be the aggregate total of all obligations of CE, including original project obligations at the authorization stage, all subsequent adjustments during the fiscal year, and all adjustments (debits or credits) to projects authorized in previous fiscal years.

(2) The CE limitation determination for each fiscal year will be treated separately and may not be adjusted after the end of that fiscal year.

(c) Projects which are closed (final voucher processed) as of December 18, 1991, may be reopened to accept adjustments and additional eligible project charges. All obligation/deobligation adjustments must be included in the current fiscal year calculation. However, the CE cost for each of these projects shall be limited to 15 percent of each project construction cost in accordance with the provisions in effect prior to December 18, 1991.

(d) If the SHA claims CE costs as an average percentage of the actual construction costs in accordance with 23 U.S.C. 120(g), the average rate shall be determined based upon reimbursable CE costs and shall not exceed 15 percent, exclusive of the costs of rights-of-way, preliminary engineering, and CE.

§ 140.207 Application of limitation.

The limitation applies to all projects financed with Federal-aid highway funds.

Subparts C–D [Reserved]

Subpart E—Administrative Settlement Costs—Contract Claims

SOURCE: 44 FR 59233, Oct. 15, 1979, unless otherwise noted.

§ 140.501 Purpose.

This regulation establishes the criteria for eligibility for reimbursement of administrative settlement costs in defense of contract claims on projects

performed by a State under Federal-aid procedures.

§ 140.503 Definition.

Administrative settlement costs are costs related to the defense and settlement of contract claims including, but not limited to, salaries of a contracting officer or his/her authorized representative, attorneys, and/or members of State boards of arbitration, appeals boards, or similar tribunals, which are allocable to the findings and determinations of contract claims, but not including administrative or overhead costs.

§ 140.505 Reimbursable costs.

(a) Federal funds may participate in administrative settlement costs which are:

- (1) Incurred after notice of claim,
- (2) Properly supported,
- (3) Directly allocable to a specific Federal-aid or Federal project,
- (4) For employment of special counsel for review and defense of contract claims, when
 - (i) Recommended by the State Attorney General or State Highway Agency (SHA) legal counsel and
 - (ii) Approved in advance by the FHWA Division Administrator, with advice of FHWA Regional Counsel, and
- (5) For travel and transportation expenses, if in accord with established policy and practices.

(b) No reimbursement shall be made if it is determined by FHWA that there was negligence or wrongdoing of any kind by SHA officials with respect to the claim.

Subpart F—Reimbursement for Bond Issue Projects

SOURCE: 48 FR 54971, Dec. 8, 1983, unless otherwise noted.

§ 140.601 Purpose.

To prescribe policies and procedures for the use of Federal funds by State highway agencies (SHAs) to aid in the retirement of the principal and interest of bonds, pursuant to 23 U.S.C. 122 and the payment of interest on bonds of eligible Interstate projects.

§ 140.602

23 CFR Ch. I (4-1-01 Edition)

§ 140.602 Requirements and conditions.

(a) An SHA that uses the proceeds of bonds issued by the State, a county, city or other political subdivision of the State, for the construction of projects on the Federal-aid primary or Interstate system, or extensions of any of the Federal-aid highway systems in urban areas, or for substitute highway projects approved under 23 U.S.C. 103(e)(4), may claim payment of any portion of such sums apportioned to it for expenditures on such system to aid in the retirement of the principal of bonds at their maturities, to the extent that the proceeds of bonds have actually been expended in the construction of projects.

(b) Any interest earned and payable on bonds, the proceeds of which were expended on Interstate projects after November 6, 1978, is an eligible cost of construction. The amount of interest eligible for participation will be based on (1) the date the proceeds were expended on the project, (2) amount expended, and (3) the date of conversion to a regularly funded project. As provided for in section 115(c), Pub. L. 95-599, November 6, 1978, interest on bonds issued in any fiscal year by a State after November 6, 1978, may be paid under the authority of 23 U.S.C. 122 only if such SHA was eligible to obligate Interstate Discretionary funds under the provisions of 23 U.S.C. 118(b) during such fiscal year, and the Administrator certifies that such eligible SHA has utilized, or will utilize to the fullest extent possible during such fiscal year, its authority to obligate funds under 23 U.S.C. 118(b).

(c) The Federal share payable at the time of conversion, as provided for in § 140.610 shall be the legal pro rata in effect at the time of execution of the project agreement for the bond issue project.

(d) The authorization of a bond issue project does not constitute a commitment of Federal funds until the project is converted to a regular Federal-aid project as provided for in § 140.610.

(e) Reimbursements for the redemption of bonds may not precede, by more than 60 days, the scheduled date of the retirement of the bonds.

(f) Federal funds are not eligible for payment into sinking funds created and maintained for the subsequent retirement of bonds.

§ 140.603 Programs.

Programs covering projects to be financed from the proceeds of bonds shall be prepared and submitted to FHWA. Project designations shall be the same as for regular Federal-aid projects except that the prefix letter "B" for bond issue shall be used as the first letter of each project designation, e.g., "BI" for Bond Issue Projects—Interstate.

§ 140.604 Reimbursable schedule.

Projects to be financed from other than Interstate funds shall be subject to a 36-month reimbursable schedule upon conversion to regular Federal-aid financing (See appendix). FHWA will consider requests for waiver of this provision at the time of conversion action. Waivers are subject to the availability of liquidating cash.

§ 140.605 Approval actions.

(a) Authorization to proceed with preliminary engineering and acquisition of rights-of-way shall be issued in the same manner as for regularly financed Federal-aid projects.

(b) Authorization of physical construction shall be given in the same manner as for regularly financed Federal-aid projects. The total cost and Federal funds required, including interest, shall be indicated in the plans, specifications, and estimates.

(c) Projects subject to the reimbursable schedule shall be identified as an "E" project when the SHA is authorized to proceed with all or any phase of the work.

(d) Concurrence in the award of contracts shall be given.

§ 140.606 Project agreements.

Project Agreements, Form PR-2, shall be prepared and executed. Agreement provision 8 on the reverse side of Form PR-2¹ shall apply for bond issue projects.

¹The text of FHWA Form PR-2 is found in 23 CFR part 630, subpart C, appendix A.

Federal Highway Administration, DOT

§ 140.612

§ 140.607 Construction.

Construction shall be supervised by the SHA in the same manner as for regularly financed Federal-aid projects. The FHWA will make construction inspections and reports.

§ 140.608 Reimbursable bond interest costs of Interstate projects.

(a) Bond interest earned on bonds actually retired may be reimbursed on the Federal pro rata basis applicable to such projects in accordance with § 140.602(b) and (c).

(b) No interest will be reimbursed for bonds issued after November 6, 1978, used to retire or otherwise refinance bonds issued prior to that date.

§ 140.609 Progress and final vouchers.

(a) Progress vouchers may be submitted for the Federal share of bonds retired or about to be retired, including eligible interest on Interstate Bond Issue Projects, the proceeds of which have actually been expended for the construction of the project.

(b) Upon completion of a bond issue project, a final voucher shall be submitted by the SHA. After final review, the SHA will be advised as to the total cost and Federal fund participation for the project.

§ 140.610 Conversion from bond issue to funded project status.

(a) At such time as the SHA elects to apply available apportioned Federal-aid funds to the retirement of bonds, including eligible interest earned and payable on Interstate Bond Projects, subject to available obligational authority, its claim shall be supported by appropriate certifications as follows:

I hereby certify that the following bonds, (list), the proceeds of which have been actually expended in the construction of bond issue projects authorized by title 23 U.S.C., section 122, (1) have been retired on ———, or (2) mature and are scheduled for retirement on ———, which is ——— days in advance of the maturity date of ———.

Eligible interest claimed on Interstate Bond Projects shall be shown for each bond and the certification shall include the statement:

I also certify that interest earned and paid or payable for each bond listed has been de-

termined from the date on and after which the respective bond proceeds were actually expended on the project.

(b) The SHA's request for full conversion of a completed projects), or partial conversion of an active or completed project(s), may be made by letter, inclusive of the appropriate certification as described in § 140.610(a) making reference to any progress payments received or the final voucher(s) previously submitted and approved in accordance with § 140.609.

(c) Approval of the conversion action shall be by the Division Administrator.

(d) The SHA's request for partial conversion of an active or completed bond issue project shall provide for: (1) Conversion to funded project status of the portion to be financed out of the balance of currently available apportioned funds, and (2) retention of the unfunded portion of the project in the bond program.

(e) Where the SHA's request involves the partial conversion of a completed bond issue project, payment of the Federal funds made available under the conversion action shall be accomplished through use of Form PR-20, Voucher for Work Performed under Provisions of the Federal-aid and Federal Highway Acts, prepared in the division office and appropriately cross-referenced to the Bond Issue Project final voucher previously submitted and approved. The final voucher will be reduced by the amount of the approved reimbursement.

§ 140.611 Determination of bond retirement.

Division Administrators shall be responsible for the prompt review of the SHA's records to determine that bonds issued to finance the projects and for which reimbursement has been made, including eligible bond interest expense, have been retired pursuant to the State's certification required by § 140.610(a), and that such action is documented in the project file.

§ 140.612 Cash management.

By July 1 of each year the SHA will provide FHWA with a schedule, including the anticipated claims for reimbursement, of bond projects to be converted during the next two fiscal years.

The data will be used by FHWA in determining liquidating cash required to finance such conversions.

APPENDIX TO SUBPART F—REIMBURSABLE SCHEDULE FOR CONVERTED “E” (BOND ISSUE) PROJECTS (OTHER THAN INTERSTATE PROJECTS)

Time in months following conversion from “E” (bond issue) project to regular project	Cumulative amount reimbursable (percent of Federal funds obligated)
1	1
2	2
3	5
4	9
5	13
6	18
7	23
8	29
9	34
10	39
11	44
12	49
13	54
14	58
15	61
16	64
17	67
18	70
19	73
20	75
21	77
22	79
23	81
24	83
25	85
26	87
27	89
28	91
29	93
30	94
31	95
32	96
34	97
35	99
36	100

Subpart G [Reserved]

Subpart H—State Highway Agency Audit Expense

SOURCE: 49 FR 45578, Nov. 19, 1984, unless otherwise noted.

§ 140.801 Purpose.

To establish the reimbursement criteria for Federal participation in project related audit expenses.

§ 140.803 Policy.

Project related audits performed in accordance with generally accepted au-

ditng standards (as modified by the Comptroller General of the United States) and applicable Federal laws and regulations are eligible for Federal participation. The State highway agency (SHA) may use other State, local public agency, and Federal audit organizations as well as licensed or certified public accounting firms to augment its audit force.

§ 140.805 Definitions.

(a) *Project related audits.* Audits which directly benefit Federal-aid highway projects. Audits performed in accordance with the requirements of 23 CFR part 12, audits of third party contract costs, and other audits providing assurance that a recipient has complied with FHWA regulations are all considered project related audits. Audits benefiting only nonfederal projects, those performed for SHA management use only, or those serving similar non-federal purposes are not considered project related.

(b) *Third party contract costs.* Project related costs incurred by railroads, utilities, consultants, governmental instrumentalities, universities, nonprofit organizations, construction contractors (force account work), and organizations engaged in right-of-way studies, planning, research, or related activities where the terms of a proposal or contract (including lump sum) necessitate an audit. Construction contracts (except force account work) are not included in this group.

§ 140.807 Reimbursable costs.

(a) Federal funds may be used to reimburse an SHA for the following types of project related audit costs:

(1) Salaries, wages, and related costs paid to public employees in accordance with subpart G of this part,

(2) Payments by the SHA to any Federal, State, or local public agency audit organization, and

(3) Payments by the SHA to licensed or certified public accounting firms.

(b) Audit costs incurred by an SHA shall be equitably distributed to all benefiting parties. The portion of these costs allocated to the Federal-Aid Highway Program which are not directly related to a specific project or projects shall be equitably distributed,

Federal Highway Administration, DOT

§ 140.906

as a minimum, to the major FHWA funding categories in that State.

Subpart I—Reimbursement for Railroad Work

SOURCE: 40 FR 16057, Apr. 9, 1975, unless otherwise noted.

§ 140.900 Purpose.

The purpose of this subpart is to prescribe policies and procedures on reimbursement to the States for railroad work done on projects undertaken pursuant to the provisions of 23 CFR part 646, subpart B.

§ 140.902 Applicability.

This subpart, and all references hereinafter made to "projects," applies to Federal-aid projects involving railroad facilities, including projects for the elimination of hazards of railroad-highway crossings, and other projects which use railroad properties or which involve adjustments required by highway construction to either railroad facilities or facilities that are jointly owned or used by railroad and utility companies.

§ 140.904 Reimbursement basis.

(a) *General.* On projects involving the elimination of hazards of railroad-highway crossings, and on other projects where a railroad company is not obligated to move or to change its facilities at its own expense, reimbursement will be made for the costs incurred by the State in making changes to railroad facilities as required in connection with a Federal-aid highway project, in accordance with the provisions of this subpart.

(b) *Eligibility.* To be eligible, the costs must be:

(1) For work which is included in an approved statewide transportation improvement program.

(2) Incurred subsequent to the date of authorization by the Federal Highway Administration (FHWA),

(3) Incurred in accordance with the provisions of 23 CFR, part 646, subpart B, and

(4) Properly attributable to the project.

[40 FR 16057, Apr. 9, 1975, as amended at 53 FR 18276, May 23, 1988; 62 FR 45328, Aug. 27, 1997]

§ 140.906 Labor costs.

(a) *General.* (1) Salaries and wages, at actual or average rates, and related expenses paid by a company to individuals, for the time they are working on the project, are reimbursable when supported by adequate records. This shall include labor costs associated with preliminary engineering, construction engineering, right-of-way, and force account construction.

(2) Salaries and expenses paid to individuals who are normally part of the overhead organization of the company may be reimbursed for the time they are working directly on the project, such as for accounting and bill preparation, when supported by adequate records and when the work performed by such individuals is essential to the project and could not have been accomplished as economically by employees outside the overhead organization.

(3) Amounts paid to engineers, architects and others for services directly related to projects may be reimbursed.

(b) *Labor surcharges.* (1) Labor surcharges include worker compensation insurance, public liability and property damage insurance, and such fringe benefits as the company has established for the benefit of its employees. The cost of labor surcharges will be reimbursed at actual cost to the company or a company may, at its option, use an additive rate or other similar technique in lieu of actual costs provided that (i) the rate is based on historical cost data of the company, (ii) such rate is representative of actual costs incurred, (iii) the rate is adjusted at least annually taking into consideration known anticipated changes and correcting for any over or under applied costs for the preceding period, and (iv) the rate is approved by the SHA and FHWA.

(2) Where the company is a self-insurer there may be reimbursement:

(i) At experience rates properly developed from actual costs, not to exceed the rates of a regular insurance

§ 140.907

23 CFR Ch. I (4-1-01 Edition)

company for the class of employment covered, or

(ii) At the option of the company, a fixed rate of 8 percent of direct labor costs for worker compensation and public liability and property damage insurance together.

[40 FR 16057, Apr. 9, 1975, as amended at 47 FR 33955, Aug. 5, 1982; 56 FR 56578, Nov. 6, 1991]

§ 140.907 Overhead and indirect construction costs.

(a) A State may elect to reimburse the railroad company for its overhead and indirect construction costs.

(b) The FHWA will participate in these costs provided that:

(1) The costs are distributed to all applicable work orders and other functions on an equitable and uniform basis in accordance with generally accepted accounting principles;

(2) The costs included in the distribution are limited to costs actually incurred by the railroad;

(3) The costs are eligible in accordance with the Federal Acquisition Regulation (48 CFR), part 31, Contract Cost Principles and Procedures, relating to contracts with commercial organizations;

(4) The costs are considered reasonable;

(5) Records are readily available at a single location which adequately support the costs included in the distribution, the method used for distributing the costs, and the basis for determining additive rates;

(6) The rates are adjusted at least annually taking into consideration any overrecovery or underrecovery of costs; and

(7) The railroad maintains written procedures which assure proper control and distribution of the overhead and indirect construction costs.

[53 FR 18276, May 23, 1988]

§ 140.908 Materials and supplies.

(a) *Procurement.* Materials and supplies, if available, are to be furnished from company stock, except they may be obtained from other sources near the project site when available at less cost. Where not available from company stock, they may be purchased either under competitive bids or existing

continuing contracts, under which the lowest available prices are developed. Minor quantities and proprietary products are excluded from these requirements. The company shall not be required to change its existing standards for materials used in permanent changes to its facilities.

(b) *Costs.* (1) Materials and supplies furnished from company stock shall be billed at current stock price of such new or used material at time of issue.

(2) Materials and supplies not furnished from company stock shall be billed at actual costs to the company delivered to the point of entry on the railroad company's line nearest the source of procurement.

(3) A reasonable cost of plant inspection and testing may be included in the costs of materials and supplies where such expense has been incurred. The computation of actual costs of materials and supplies shall include the deduction of all offered discounts, rebates and allowances.

(c) *Materials recovered.* (1) Materials recovered from temporary use and accepted for reuse by the company shall be credited to the project at prices charged to the job, less a consideration for loss in service life at 10 percent for rails, angle bars, tie plates and metal turnout materials and 15 percent for all other materials. Materials recovered from the permanent facility of the company that are accepted by the company for return to stock shall be credited to the project at current stock prices of such used material.

(2) Materials recovered and not accepted for reuse by the company, if determined to have a net sale value, shall be sold by the State or railroad following an opportunity for State inspection and appropriate solicitation for bids, to the highest bidder; or if the company practices a system of periodic disposal by sale, credit to the project shall be at the going prices supported by the records of the company. Where applicable, credit for materials recovered from the permanent facility in length or quantities in excess of that being placed should be reduced to reflect any increased cost of railroad operation resulting from the adjustment.

(d) *Removal costs.* Federal participation in the costs of removing, salvaging, transporting, and handling recovered materials will be limited to the value of materials recovered, except where FHWA approves additional measures for restoration of affected areas as required by the physical construction or by reason of safety or aesthetics.

(e) *Handling costs.* The actual and direct costs of handling and loading out of materials and supplies at and from company stores or material yards and of unloading and handling of recovered materials accepted by the company at its stores or material yards, are reimbursable. At the option of the company, 5 percent of the amounts billed for the materials and supplies which are issued from company stores and material yards will be reimbursable in lieu of actual costs.

(f) *Credit losses.* On projects where a company actually suffers loss by application of credits, the company shall have the opportunity of submitting a detailed statement of such loss as a basis for further adjustment.

§ 140.910 Equipment.

(a) *Company owned equipment.* Cost of company-owned equipment may be reimbursed for the average or actual cost of operation, light and running repairs, and depreciation, or at industry rates representative of actual costs as agreed to by the railroad, SHA, and FHWA. Reimbursement for company-owned vehicles may be made at average or actual costs or at rates of recorded use per mile which are representative of actual costs and agreed to by the company, SHA, and FHWA.

(b) *Other equipment.* Where company owned equipment is not available, reimbursement will be limited to the amount of rental paid (1) to the lowest qualified bidder, (2) under existing continuing contracts at reasonable cost, or (3) as an exception, by negotiation where (b) (1) and (2) are impractical due to project location or schedule.

[40 FR 16057, Apr. 9, 1975, as amended at 47 FR 33955, Aug. 5, 1982]

§ 140.912 Transportation.

(a) *Employees.* The company's cost of necessary employee transportation and

subsistence directly attributable to the project, which is consistent with overall policy of the company, is reimbursable.

(b) *Materials, supplies, and equipment.* The most economical movement of materials, supplies and equipment to the project and necessary return to storage, including the associated costs of loading and unloading equipment, is reimbursable. Transportation by a railroad company over its own lines in a revenue train is reimbursable at average or actual costs, at rates which are representative of actual costs, or at rates which the company charges its customers for similar shipments provided the rate structure is documented and available to the public. These rates are to be agreed to by the company, SHA, and FHWA. No charge will be made for transportation by work train other than the operating expenses of the work train. When it is more practicable or more economical to move equipment on its own wheels, reimbursement may be made at average or actual costs or at rates which are representative of actual costs and are agreed to by the railroad, SHA, and FHWA.

[40 FR 16057, Apr. 9, 1975, as amended at 47 FR 33955, Aug. 5, 1982]

§ 140.914 Credits for improvements.

(a) Credit shall be made to the project for additions or improvements which provide for higher quality or increased service capability of the operating facility and which are provided solely for the benefit of the company.

(b) Where buildings and other depreciable structures of a company which are integral to operation of rail traffic must be replaced, credit shall be made to the project as set forth in 23 CFR 646.216(c)(2).

(c) No credit is required for additions or improvements which are:

(1) Necessitated by the requirements of the highway project.

(2) Replacements which, although not identical, are of equivalent standard.

(3) Replacements of devices or materials no longer regularly manufactured and the next highest grade or size is used.

§ 140.916

(4) Required by governmental and appropriate regulatory commission requirements.

§ 140.916 Protection.

The cost of essential protective services which, in the opinion of a railroad company, are required to ensure safety to railroad operations during certain periods of the construction of a project, is reimbursable provided an item for such services is incorporated in the State-railroad agreement or in a work order issued by the State and approved by FHWA.

§ 140.918 Maintenance and extended construction.

The cost of maintenance and extended construction is reimbursable to the extent provided for in 23 CFR 646.216(f)(4), and where included in the State-Railroad Agreement or otherwise approved by the State and FHWA.

§ 140.920 Lump sum payments.

Where approved by FHWA, pursuant to 23 CFR 646.216(d)(3), reimbursement may be made as a lump sum payment, in lieu of actual costs.

§ 140.922 Billings.

(a) After the executed State-Railroad Agreement has been approved by FHWA, the company may be reimbursed on progress billings of incurred costs. Costs for materials stockpiled at the project site or specifically purchased and delivered to the company for use on the project may be reimbursed on progress billings following approval of the executed State-Railroad Agreement or the written agreement under 23 CFR 646.218(c).

(b) The company shall provide one final and complete billing of all incurred costs, or of the agreed-to lump sum, within one year following completion of the reimbursable railroad work. Otherwise, previous payments to the company may be considered final, except as agreed to between the SHA and the railroad.

(c) All company cost records and accounts relating to the project are subject to audit by representatives of the State and/or the Federal Government for a period of three years from the

23 CFR Ch. I (4-1-01 Edition)

date final payment has been received by the company.

(d) A railroad company must advise the State promptly of any outstanding obligation of the State's contractor for services furnished by the company such as protective services.

[40 FR 16057, Apr. 9, 1975, as amended at 40 FR 29712, July 15, 1975; 62 FR 45328, Aug. 27, 1997]

PART 172—ADMINISTRATION OF ENGINEERING AND DESIGN RELATED SERVICE CONTRACTS

Subpart A—Procurement Procedures

Sec.	
172.1	Purpose and applicability.
172.3	Definitions.
172.5	General principles.
172.7	Methods of procurement.
172.9	Compensation.
172.11	Contract modifications.
172.13	Monitoring the contract work.
172.15	Alternate procedures.

Subpart B—Private Sector Involvement Program

172.21	Purpose and applicability.
172.23	Evaluation and selection.
172.25	Funding.

AUTHORITY: 23 U.S.C. 112(b), 114(a), 302, 315, and 402; 49 CFR 1.48(b) and 18; 48 CFR 12 and 31; 41 U.S.C. 253 and 259; and sec. 1060, Pub. L. 102-240, 105 Stat. 1914, 2003 (1991).

SOURCE: 56 FR 19802, Apr. 30, 1991, unless otherwise noted.

Subpart A—Procurement Procedures

§ 172.1 Purpose and applicability.

(a) To prescribe policies and procedures for contracting to ensure that a qualified consultant is obtained through an equitable selection process, and that prescribed work is properly accomplished in a timely manner, at a reasonable cost.

(b) This regulation applies to all engineering and design related service contracts financed with Federal-aid highway funds. Agencies with approved Certification Acceptance Plans (CA), Secondary Road Plans (SRP) and/or Combined Road Plans (CRP) shall submit for the Federal Highway Administration's (FHWA) approval, procedures

the FHWA for use on Federal-aid highway projects.

(e) The State transportation department's practices under the policies or agreements approved under §645.215(b) of this part shall be periodically reviewed by the FHWA.

(Information collection requirements in paragraph (a) were approved by the Office of Management and Budget under control number 2125-0514)

[50 FR 20354, May 15, 1985, as amended at 53 FR 2834, Feb. 2, 1988; 60 FR 34851, July 5, 1995; 65 FR 70312, Nov. 22, 2000]

PART 646—RAILROADS

Subpart A—Railroad-Highway Insurance Protection

Sec.

- 646.101 Purpose.
- 646.103 Application.
- 646.105 Contractor's public liability and property damage insurance.
- 646.107 Railroad protective insurance.
- 646.109 Types of coverage.
- 646.111 Amount of coverage.

Subpart B—Railroad-Highway Projects

- 646.200 Purpose and applicability.
- 646.202 [Reserved]
- 646.204 Definitions.
- 646.206 Types of projects.
- 646.208 Funding.
- 646.210 Classification of projects and railroad share of the cost.
- 646.212 Federal share.
- 646.214 Design.
- 646.216 General procedures.
- 646.218 Simplified procedure for accelerating grade crossing improvements.
- 646.220 Alternate Federal-State procedure.

APPENDIX TO SUBPART B—HORIZONTAL AND VERTICAL CLEARANCE PROVISIONS FOR OVERPASS AND UNDERPASS STRUCTURES

AUTHORITY: 23 U.S.C. 109(e), 120(c), 130, 133(d)(1), and 315; 49 CFR 1.48(b).

Subpart A—Railroad-Highway Insurance Protection

SOURCE: 39 FR 36474, Oct. 10, 1974, unless otherwise noted.

§ 646.101 Purpose.

The purpose of this part is to prescribe provisions under which Federal funds may be applied to the costs of public liability and property damage insurance obtained by contractors (a)

for their own operations, and (b) on behalf of railroads on or about whose right-of-way the contractors are required to work in the construction of highway projects financed in whole or in part with Federal funds.

§ 646.103 Application.

(a) This part applies:

(1) To a contractor's legal liability for bodily injury to, or death of, persons and for injury to, or destruction of, property.

(2) To the liability which may attach to railroads for bodily injury to, or death of, persons and for injury to, or destruction of, property.

(3) To damage to property owned by or in the care, custody or control of the railroads, both as such liability or damage may arise out of the contractor's operations, or may result from work performed by railroads at or about railroad rights-of-way in connection with projects financed in whole or in part with Federal funds.

(b) Where the highway construction is under the direct supervision of the Federal Highway Administration (FHWA), all references herein to the State shall be considered as references to the FHWA.

§ 646.105 Contractor's public liability and property damage insurance.

(a) Contractors may be subject to liability with respect to bodily injury to or death of persons, and injury to, or destruction of property, which may be suffered by persons other than their own employees as a result of their operations in connection with construction of highway projects located in whole or in part within railroad right-of-way and financed in whole or in part with Federal funds. Protection to cover such liability of contractors shall be furnished under regular contractors' public liability and property damage insurance policies issued in the names of the contractors. Such policies shall be so written as to furnish protection to contractors respecting their operations in performing work covered by their contract.

(b) Where a contractor sublets a part of the work on any project to a subcontractor, the contractor shall be required to secure insurance protection

Federal Highway Administration, DOT

§ 646.111

in his own behalf under contractor's public liability and property damage insurance policies to cover any liability imposed on him by law for damages because of bodily injury to, or death of, persons and injury to, or destruction of, property as a result of work undertaken by such subcontractors. In addition, the contractor shall provide for and on behalf of any such subcontractors protection to cover like liability imposed upon the latter as a result of their operations by means of separate and individual contractor's public liability and property damage policies; or, in the alternative, each subcontractor shall provide satisfactory insurance on his own behalf to cover his individual operations.

(c) The contractor shall furnish to the State highway department evidence satisfactory to such department and to the FHWA that the insurance coverages required herein have been provided. The contractor shall also furnish a copy of such evidence to the railroad or railroads involved. The insurance specified shall be kept in force until all work required to be performed shall have been satisfactorily completed and accepted in accordance with the contract under which the construction work is undertaken.

§ 646.107 Railroad protective insurance.

In connection with highway projects for the elimination of hazards of railroad-highway crossings and other highway construction projects located in whole or in part within railroad right-of-way, railroad protective liability insurance shall be purchased on behalf of the railroad by the contractor. The standards for railroad protective insurance established by §§ 646.109 through 646.111 shall be adhered to insofar as the insurance laws of the State will permit.

[39 FR 36474, Oct. 10, 1974, as amended at 47 FR 33955, Aug. 5, 1982]

§ 646.109 Types of coverage.

(a) Coverage shall be limited to damage suffered by the railroad on account of occurrences arising out of the work of the contractor on or about the railroad right-of-way, independent of the

railroad's general supervision or control, except as noted in § 646.109(b)(4).

(b) Coverage shall include:

(1) Death of or bodily injury to passengers of the railroad and employees of the railroad not covered by State workmen's compensation laws;

(2) Personal property owned by or in the care, custody or control of the railroads;

(3) The contractor, or any of his agents or employees who suffer bodily injury or death as the result of acts of the railroad or its agents, regardless of the negligence of the railroad;

(4) Negligence of only the following classes of railroad employees:

(i) Any supervisory employee of the railroad at the job site;

(ii) Any employee of the railroad while operating, attached to, or engaged on, work trains or other railroad equipment at the job site which are assigned exclusively to the contractor; or

(iii) Any employee of the railroad not within (b)(4) (i) or (ii) who is specifically loaned or assigned to the work of the contractor for prevention of accidents or protection of property, the cost of whose services is borne specifically by the contractor or governmental authority.

§ 646.111 Amount of coverage.

(a) The maximum dollar amounts of coverage to be reimbursed from Federal funds with respect to bodily injury, death and property damage is limited to a combined amount of \$2 million per occurrence with an aggregate of \$6 million applying separately to each annual period except as provided in paragraph (b) of this section.

(b) In cases involving real and demonstrable danger of appreciably higher risks, higher dollar amounts of coverage for which premiums will be reimbursable from Federal funds shall be allowed. These larger amounts will depend on circumstances and shall be written for the individual project in accordance with standard underwriting practices upon approval of the FHWA.

[39 FR 36474, Oct. 10, 1974, as amended at 47 FR 33955, Aug. 5, 1982]

Subpart B—Railroad-Highway Projects

SOURCE: 40 FR 16059, Apr. 9, 1975, unless otherwise noted.

§ 646.200 Purpose and applicability.

(a) The purpose of this subpart is to prescribe policies and procedures for advancing Federal-aid projects involving railroad facilities.

(b) This subpart, and all references hereinafter made to *projects*, applies to Federal-aid projects involving railroad facilities, including projects for the elimination of hazards of railroad-highway crossings, and other projects which use railroad properties or which involve adjustments required by highway construction to either railroad facilities or facilities that are jointly owned or used by railroad and utility companies.

(c) Additional instructions for projects involving the elimination of hazards of railroad/highway grade crossings pursuant to 23 U.S.C. 130 are set forth in 23 CFR part 924.

(d) Procedures on reimbursement for projects undertaken pursuant to this subpart are set forth in 23 CFR part 140, subpart I.

(e) Procedures on insurance required of contractors working on or about railroad right-of-way are set forth in 23 CFR part 646, subpart A.

[40 FR 16059, Apr. 9, 1975, as amended at 45 FR 20795, Mar. 31, 1980; 62 FR 45328, Aug. 27, 1997]

§ 646.202 [Reserved]

§ 646.204 Definitions.

For the purposes of this subpart, the following definitions apply:

Active warning devices means those traffic control devices activated by the approach or presence of a train, such as flashing light signals, automatic gates and similar devices, as well as manually operated devices and crossing watchmen, all of which display to motorists positive warning of the approach or presence of a train.

Company shall mean any railroad or utility company including any wholly owned or controlled subsidiary thereof.

Construction shall mean the actual physical construction to improve or

eliminate a railroad-highway grade crossing or accomplish other railroad involved work.

A diagnostic team means a group of knowledgeable representatives of the parties of interest in a railroad-highway crossing or a group of crossings.

Main line railroad track means a track of a principal line of a railroad, including extensions through yards, upon which trains are operated by timetable or train order or both, or the use of which is governed by block signals or by centralized traffic control.

Passive warning devices means those types of traffic control devices, including signs, markings and other devices, located at or in advance of grade crossings to indicate the presence of a crossing but which do not change aspect upon the approach or presence of a train.

Preliminary engineering shall mean the work necessary to produce construction plans, specifications, and estimates to the degree of completeness required for undertaking construction thereunder, including locating, surveying, designing, and related work.

Railroad shall mean all rail carriers, publicly-owned, private, and common carriers, including line haul freight and passenger railroads, switching and terminal railroads and passenger carrying railroads such as rapid transit, commuter and street railroads.

Utility shall mean the lines and facilities for producing, transmitting or distributing communications, power, electricity, light, heat, gas, oil, water, steam, sewer and similar commodities.

[40 FR 16059, Apr. 9, 1975, as amended at 62 FR 45328, Aug. 27, 1997]

§ 646.206 Types of projects.

(a) Projects for the elimination of hazards, to both vehicles and pedestrians, of railroad-highway crossings may include but are not limited to:

- (1) Grade crossing elimination;
- (2) Reconstruction of existing grade separations; and
- (3) Grade crossing improvements.

(b) Other railroad-highway projects are those which use railroad properties or involve adjustments to railroad facilities required by highway construction but do not involve the elimination

Federal Highway Administration, DOT

§ 646.212

of hazards of railroad-highway crossings. Also included are adjustments to facilities that are jointly owned or used by railroad and utility companies.

§ 646.208 Funding.

(a) Railroad/highway crossing projects may be funded through the Federal-aid funding source appropriate for the involved project.

(b) Projects for the elimination of hazards at railroad/highway crossings may, at the option of the State, be funded with the funds provided by 23 U.S.C. 133(d)(1).

[62 FR 45328, Aug. 27, 1997]

§ 646.210 Classification of projects and railroad share of the cost.

(a) State laws requiring railroads to share in the cost of work for the elimination of hazards at railroad-highway crossings shall not apply to Federal-aid projects.

(b) Pursuant to 23 U.S.C. 130(b), and 49 CFR 1.48:

(1) Projects for grade crossing improvements are deemed to be of no ascertainable net benefit to the railroads and there shall be no required railroad share of the costs.

(2) Projects for the reconstruction of existing grade separations are deemed to generally be of no ascertainable net benefit to the railroad and there shall be no required railroad share of the costs, unless the railroad has a specific contractual obligation with the State or its political subdivision to share in the costs.

(3) On projects for the elimination of existing grade crossings at which active warning devices are in place or ordered to be installed by a State regulatory agency, the railroad share of the project costs shall be 5 percent.

(4) On projects for the elimination of existing grade crossings at which active warning devices are not in place and have not been ordered installed by a State regulatory agency, or on projects which do not eliminate an existing crossing, there shall be no required railroad share of the project cost.

(c) The required railroad share of the cost under § 646.210(b)(3) shall be based on the costs for preliminary engineer-

ing, right-of-way and construction within the limits described below:

(1) Where a grade crossing is eliminated by grade separation, the structure and approaches required to transition to a theoretical highway profile which would have been constructed if there were no railroad present, for the number of lanes on the existing highway and in accordance with the current design standards of the State highway agency.

(2) Where another facility, such as a highway or waterway, requiring a bridge structure is located within the limits of a grade separation project, the estimated cost of a theoretical structure and approaches as described in § 646.210(c)(1) to eliminate the railroad-highway grade crossing without considering the presence of the waterway or other highway.

(3) Where a grade crossing is eliminated by railroad or highway relocation, the actual cost of the relocation project, the estimated cost of the relocation project, or the estimated cost of a structure and approaches as described in § 646.210(c)(1), whichever is less.

(d) Railroads may voluntarily contribute a greater share of project costs than is required. Also, other parties may voluntarily assume the railroad's share.

§ 646.212 Federal share.

(a) *General.* (1) Federal funds are not eligible to participate in costs incurred solely for the benefit of the railroad.

(2) At grade separations Federal funds are eligible to participate in costs to provide space for more tracks than are in place when the railroad establishes to the satisfaction of the State highway agency and FHWA that it has a definite demand and plans for installation of the additional tracks within a reasonable time.

(3) The Federal share of the cost of a grade separation project shall be based on the cost to provide horizontal and/or vertical clearances used by the railroad in its normal practice subject to limitations as shown in the appendix or as required by a State regulatory agency.

(b) The Federal share of railroad/highway crossing projects may be:

§ 646.214

(1) Regular pro rata sharing as provided by 23 U.S.C. 120(a) and 120(b).

(2) One hundred percent Federal share, as provided by 23 U.S.C. 120(c).

(3) Ninety percent Federal share for funds made available through 23 U.S.C. 133(d)(1).

[40 FR 16059, Apr. 9, 1975, as amended at 47 FR 33955, Aug. 5, 1982; 53 FR 32218, Aug. 24, 1988; 62 FR 45328, Aug. 27, 1997]

§ 646.214 Design.

(a) *General.* (1) Facilities that are the responsibility of the railroad for maintenance and operation shall conform to the specifications and design standards used by the railroad in its normal practice, subject to approval by the State highway agency and FHWA.

(2) Facilities that are the responsibility of the highway agency for maintenance and operation shall conform to the specifications and design standards and guides used by the highway agency in its normal practice for Federal-aid projects.

(b) *Grade crossing improvements.* (1) All traffic control devices proposed shall comply with the latest edition of the Manual on Uniform Traffic Control Devices for Streets and Highways supplemented to the extent applicable by State standards.

(2) Pursuant to 23 U.S.C. 109(e), where a railroad-highway grade crossing is located within the limits of or near the terminus of a Federal-aid highway project for construction of a new highway or improvement of the existing roadway, the crossing shall not be opened for unrestricted use by traffic or the project accepted by FHWA until adequate warning devices for the crossing are installed and functioning properly.

(3)(i) *Adequate warning devices*, under § 646.214(b)(2) or on any project where Federal-aid funds participate in the installation of the devices are to include automatic gates with flashing light signals when one or more of the following conditions exist:

(A) Multiple main line railroad tracks.

(B) Multiple tracks at or in the vicinity of the crossing which may be occupied by a train or locomotive so as to obscure the movement of another train approaching the crossing.

23 CFR Ch. I (4-1-01 Edition)

(C) High Speed train operation combined with limited sight distance at either single or multiple track crossings.

(D) A combination of high speeds and moderately high volumes of highway and railroad traffic.

(E) Either a high volume of vehicular traffic, high number of train movements, substantial numbers of schoolbuses or trucks carrying hazardous materials, unusually restricted sight distance, continuing accident occurrences, or any combination of these conditions.

(F) A diagnostic team recommends them.

(ii) In individual cases where a diagnostic team justifies that gates are not appropriate, FHWA may find that the above requirements are not applicable.

(4) For crossings where the requirements of § 646.214(b)(3) are not applicable, the type of warning device to be installed, whether the determination is made by a State regulatory agency, State highway agency, and/or the railroad, is subject to the approval of FHWA.

(c) *Grade crossing elimination.* All crossings of railroads and highways at grade shall be eliminated where there is full control of access on the highway (a freeway) regardless of the volume of railroad or highway traffic.

[40 FR 16059, Apr. 9, 1975, as amended at 47 FR 33955, Aug. 5, 1982; 62 FR 45328, Aug. 27, 1997]

§ 646.216 General procedures.

(a) *General.* Unless specifically modified herein, applicable Federal-aid procedures govern projects undertaken pursuant to this subpart.

(b) *Preliminary engineering and engineering services.* (1) As mutually agreed to by the State highway agency and railroad, and subject to the provisions of § 646.216(b)(2), preliminary engineering work on railroad-highway projects may be accomplished by one of the following methods:

(i) The State or railroad's engineering forces;

(ii) An engineering consultant selected by the State after consultation with the railroad, and with the State administering the contract; or

(iii) An engineering consultant selected by the railroad, with the approval of the State and with the railroad administering the contract.

(2) Where a railroad is not adequately staffed, Federal-aid funds may participate in the amounts paid to engineering consultants and others for required services, provided such amounts are not based on a percentage of the cost of construction, either under contracts for individual projects or under existing written continuing contracts where such work is regularly performed for the railroad in its own work under such contracts at reasonable costs.

(c) *Rights-of-way.* (1) Acquisition of right-of-way by a State highway agency on behalf of a railroad or acquisition of nonoperating real property from a railroad shall be in accordance with the Uniform Relocation Assistance and Real Property Acquisition Policies Act of 1970 (42 U.S.C. 4601 *et seq.*) and applicable FHWA right-of-way procedures in 23 CFR, chapter I, subchapter H. On projects for the elimination of hazards of railroad-highway crossings by the relocation of railroads, acquisition or replacement right-of-way by a railroad shall be in accordance with 42 U.S.C. 4601 *et seq.*

(2) Where buildings and other depreciable structures of the railroad (such as signal towers, passenger stations, depots, and other buildings, and equipment housings) which are integral to operation of railroad traffic are wholly or partly affected by a highway project, the costs of work necessary to functionally restore such facilities are eligible for participation. However, when replacement of such facilities is necessary, credits shall be made to the cost of the project for:

(i) Accrued depreciation, which is that amount based on the ratio between the period of actual length of service and total life expectancy applied to the original cost.

(ii) Additions or improvements which provide higher quality or increased service capability of the facility and which are provided solely for the benefit of the railroad.

(iii) Actual salvage value of the material recovered from the facility being replaced. Total credits to a project

shall not be required in excess of the replacement cost of the facility.

(3) Where Federal funds participate in the cost of replacement right-of-way, there will be no charge to the project for the railroad's existing right-of-way being transferred to the State highway agency except when the value of the right-of-way being taken exceeds the value of the replacement right-of-way.

(d) *State-railroad agreements.* (1) Where construction of a Federal-aid project requires use of railroad properties or adjustments to railroad facilities, there shall be an agreement in writing between the State highway agency and the railroad company.

(2) The written agreement between the State and the railroad shall, as a minimum include the following, where applicable:

(i) The provisions of this subpart and of 23 CFR part 140, subpart I, incorporated by reference.

(ii) A detailed statement of the work to be performed by each party.

(iii) Method of payment (either actual cost or lump sum),

(iv) For projects which are not for the elimination of hazards of railroad-highway crossings, the extent to which the railroad is obligated to move or adjust its facilities at its own expense,

(v) The railroad's share of the project cost,

(vi) An itemized estimate of the cost of the work to be performed by the railroad,

(vii) Method to be used for performing the work, either by railroad forces or by contract,

(viii) Maintenance responsibility,

(ix) Form, duration, and amounts of any needed insurance,

(x) Appropriate reference to or identification of plans and specifications,

(xi) Statements defining the conditions under which the railroad will provide or require protective services during performance of the work, the type of protective services and the method of reimbursement to the railroad, and

(xii) Provisions regarding inspection of any recovered materials.

(3) On work to be performed by the railroad with its own forces and where the State highway agency and railroad agree, subject to approval by FHWA,

§ 646.216

23 CFR Ch. I (4-1-01 Edition)

an agreement providing for a lump sum payment in lieu of later determination of actual costs may be used for any of the following:

(i) Installation or improvement of grade crossing warning devices and/or grade crossing surfaces, regardless of cost, or

(ii) Any other eligible work where the estimated cost to the State of the proposed railroad work does not exceed \$100,000 or

(iii) Where FHWA finds that the circumstances are such that this method of developing costs would be in the best interest of the public.

(4) Where the lump sum method of payment is used, periodic reviews and analyses of the railroad's methods and cost data used to develop lump sum estimates will be made.

(5) Master agreements between a State and a railroad on an areawide or statewide basis may be used. These agreements would contain the specifications, regulations, and provisions required in conjunction with work performed on all projects. Supporting data for each project or group of projects must, when combined with the master agreement by reference, satisfy the provisions of § 646.216(d)(2).

(6) Official orders issued by regulatory agencies will be accepted in lieu of State-railroad agreements only where, together with supplementary written understandings between the State and the railroad, they include the items required by § 646.216(d)(2).

(7) In extraordinary cases where FHWA finds that the circumstances are such that requiring such agreement or order would not be in the best interest of the public, projects may be approved for construction with the aid of Federal funds, provided satisfactory commitments have been made with respect to construction, maintenance and the railroad share of project costs.

(e) *Authorizations.* (1) The costs of preliminary engineering, right-of-way acquisition, and construction incurred after the date each phase of the work is included in an approved statewide transportation improvement program and authorized by the FHWA are eligible for Federal-aid participation. Preliminary engineering and right-of-way acquisition costs which are otherwise

eligible, but incurred by a railroad prior to authorization by the FHWA, although not reimbursable, may be included as part of the railroad share of project cost where such a share is required.

(2) Prior to issuance of authorization by FHWA either to advertise the physical construction for bids or to proceed with force account construction for railroad work or for other construction affected by railroad work, the following must be accomplished:

(i) The plans, specifications and estimates must be approved by FHWA.

(ii) A proposed agreement between the State and railroad must be found satisfactory by FHWA. Before Federal funds may be used to reimburse the State for railroad costs the executed agreement must be approved by FHWA. However, cost for materials stockpiled at the project site or specifically purchased and delivered to the company for use on the project may be reimbursed on progress billings prior to the approval of the executed State-Railroad Agreement in accordance with 23 CFR 140.922(a) and § 646.218 of this part.

(iii) Adequate provisions must be made for any needed easements, right-of-way, temporary crossings for construction purposes or other property interests.

(iv) The pertinent portions of the State-railroad agreement applicable to any protective services required during performance of the work must be included in the project specifications and special provisions for any construction contract.

(3) In unusual cases, pending compliance with § 646.216(e)(2)(ii), (iii) and (iv), authorization may be given by FHWA to advertise for bids for highway construction under conditions where a railroad grants a right-of-entry to its property as necessary to prosecute the physical construction.

(f) *Construction.* (1) Construction may be accomplished by:

(i) Railroad force account,

(ii) Contracting with the lowest qualified bidder based on appropriate solicitation,

(iii) Existing continuing contracts at reasonable costs, or

Federal Highway Administration, DOT

§ 646.220

(iv) Contract without competitive bidding, for minor work, at reasonable costs.

(2) Reimbursement will not be made for any increased costs due to changes in plans:

(i) For the convenience of the contractor, or

(ii) Not approved by the State and FHWA.

(3) The State and FHWA shall be afforded a reasonable opportunity to inspect materials recovered by the railroad prior to disposal by sale or scrap. This requirement will be satisfied by the railroad giving written notice, or oral notice with prompt written confirmation, to the State of the time and place where the materials will be available for inspection. The giving of notice is the responsibility of the railroad, and it may be held accountable for full value of materials disposed of without notice.

(4) In addition to normal construction costs, the following construction costs are eligible for participation with Federal-aid funds when approved by the State and FHWA:

(i) The cost of maintaining temporary facilities of a railroad company required by and during the highway construction to the extent that such costs exceed the documented normal cost of maintaining the permanent facilities.

(ii) The cost of stage or extended construction involving grade corrections and/or slope stabilization for permanent tracks of a railroad which are required to be relocated on new grade by the highway construction. Stage or extended construction will be approved by FHWA only when documentation submitted by the State establishes the proposed method of construction to be the only practical method and that the cost of the extended construction within the period specified is estimated to be less than the cost of any practicable alternate procedure.

(iii) The cost of restoring the company's service by adjustments of existing facilities away from the project site, in lieu of and not to exceed the cost of replacing, adjusting or relocating facilities at the project site.

(iv) The cost of an addition or improvement to an existing railroad facil-

ity which is required by the highway construction.

[40 FR 16059, Apr. 9, 1975, as amended at 40 FR 29712, July 15, 1975; 47 FR 33956, Aug. 5, 1982; 62 FR 45328, Aug. 27, 1997]

§ 646.218 Simplified procedure for accelerating grade crossing improvements.

(a) The procedure set forth in this section is encouraged for use in simplifying and accelerating the processing of single or multiple grade crossing improvements.

(b) Eligible preliminary engineering costs may include those incurred in selecting crossings to be improved, determining the type of improvement for each crossing, estimating the cost and preparing the required agreement.

(c) The written agreement between a State and a railroad shall contain as a minimum:

(1) Identification of each crossing location.

(2) Description of improvement and estimate of cost for each crossing location.

(3) Estimated schedule for completion of work at each location.

(d) Following programming, authorization and approval of the agreement under § 646.218(c), FHWA may authorize construction, including acquisition of warning device materials, with the condition that work at any particular location will not be undertaken until the proposed or executed State-railroad agreement under § 646.216(d)(2) is found satisfactory by FHWA and the final plans, specifications, and estimates are approved and with the condition that only material actually incorporated into the project will be eligible for Federal participation.

(e) Work programmed and authorized under this simplified procedure should include only that which can reasonably be expected to reach the construction stage within one year and be completed within two years after the initial authorization date.

§ 646.220 Alternate Federal-State procedure.

(a) On other than Interstate projects, an alternate procedure may be used, at the election of the State, for processing certain types of railroad-highway

work. Under this procedure, the State highway agency will act in the relative position of FHWA for reviewing and approving projects.

(b) The scope of the State's approval authority under the alternate procedure includes all actions necessary to advance and complete the following types of railroad-highway work:

(1) All types of grade crossing improvements under § 646.206(a)(3).

(2) Minor adjustments to railroad facilities under § 646.206(b).

(c) The following types of work are to be reviewed and approved in the normal manner, as prescribed elsewhere in this subpart.

(1) All projects under § 646.206(a)(1) and (2).

(2) Major adjustments to railroad facilities under § 646.206(b).

(d) Any State wishing to adopt the alternate procedure may file a formal application for approval by FHWA. The application must include the following:

(1) The State's written policies and procedures for administering and processing Federal-aid railroad-highway work, which make adequate provisions with respect to all of the following:

(i) Compliance with the provisions of title 23 U.S.C., title 23 CFR, and other applicable Federal laws and Executive Orders.

(ii) Compliance with this subpart and 23 CFR part 140, subpart I and 23 CFR part 172.

(iii) For grade crossing safety improvements, compliance with the requirements of 23 CFR part 924.

(2) A statement signed by the Chief Administrative Officer of the State highway agency certifying that:

(i) The work will be done in accordance with the applicable provisions of the State's policies and procedures submitted under § 646.220(d)(1), and

(ii) Reimbursement will be requested in only those costs properly attributable to the highway construction and eligible for Federal fund participation.

(e) When FHWA has approved the alternate procedure, it may authorize the State to proceed in accordance with the State's certification, subject to the following conditions:

(1) The work has been programmed.

(2) The State submits in writing a request for such authorization which

shall include a list of the improvements or adjustments to be processed under the alternate procedure, along with the best available estimate of cost.

(f) The FHWA Regional Administrator may suspend approval of the certified procedure, where FHWA reviews disclose noncompliance with the certification. Federal-aid funds will not be eligible to participate in costs that do not qualify under § 646.220(d)(1).

[40 FR 16059, Apr. 9, 1975; 40 FR 29712, July 15, 1975; 40 FR 31211, July 25, 1975; 42 FR 30835, June 17, 1977, as amended at 45 FR 20795, Mar. 31, 1980]

APPENDIX TO SUBPART B OF PART 646— HORIZONTAL AND VERTICAL CLEARANCE PROVISIONS FOR OVERPASS AND UNDERPASS STRUCTURES

The following implements provisions of 23 CFR 646.212(a)(3).

a. *Lateral Geometrics*

A cross section with a horizontal distance of 6.1 meters, measured at right angles from the centerline of track at the top of rails, to the face of the embankment slope, may be approved. The 6.1-meters distance may be increased at individual structure locations as appropriate to provide for drainage if justified by a hydraulic analysis or to allow adequate room to accommodate special conditions, such as where heavy and drifting snow is a problem. The railroad must demonstrate that this is its normal practice to address these special conditions in the manner proposed. Additionally, this distance may also be increased up to 2.5 meters as may be necessary for off-track maintenance equipment, provided adequate horizontal clearance is not available in adjacent spans and where justified by the presence of an existing maintenance road or by evidence of future need for such equipment. All piers should be placed at least 2.8 meters horizontally from the centerline of the track and preferably beyond the drainage ditch. For multiple track facilities, all dimensions apply to the centerline of the outside track.

Any increase above the 6.1-meters horizontal clearance distance must be required by specific site conditions and be justified by the railroad to the satisfaction of the State highway agency (SHA) and the FHWA.

b. *Vertical Clearance*

A vertical clearance of 7.1 meters above the top of rails, which includes an allowance for future ballasting of the railroad tracks, may be approved. Vertical clearance greater than 7.1 meters may be approved when the State regulatory agency having jurisdiction over such matters requires a vertical clearance in excess of 7.1 meters or on a site by

site basis where justified by the railroad to the satisfaction of the SHA and the FHWA. A railroad's justification for increased vertical clearance should be based on an analysis of engineering, operational and/or economic conditions at a specific structure location.

Federal-aid highway funds are also eligible to participate in the cost of providing vertical clearance greater than 7.1 meters where a railroad establishes to the satisfaction of a SHA and the FHWA that it has a definite formal plan for electrification of its rail system where the proposed grade separation project is located. The plan must cover a logical independent segment of the rail system and be approved by the railroad's corporate headquarters. For 25 kv line, a vertical clearance of 7.4 meters may be approved. For 50 kv line, a vertical clearance of 8.0 meters may be approved.

A railroad's justification to support its plan for electrification shall include maps and plans or drawings showing those lines to be electrified; actions taken by its corporate headquarters committing it to electrification including a proposed schedule; and actions initiated or completed to date implementing its electrification plan such as a showing of the amounts of funds and identification of structures, if any, where the railroad has expended its own funds to provide added clearance for the proposed electrification. If available, the railroad's justification should include information on its contemplated treatment of existing grade separations along the section of its rail system proposed for electrification.

The cost of reconstructing or modifying any existing railroad-highway grade separation structures solely to accommodate electrification will not be eligible for Federal-aid highway fund participation.

c. Railroad Structure Width

Two and eight tenths meters of structure width outside of the centerline of the outside tracks may be approved for a structure carrying railroad tracks. Greater structure width may be approved when in accordance with standards established and used by the affected railroad in its normal practice.

In order to maintain continuity of off-track equipment roadways at structures carrying tracks over limited access highways, consideration should be given at the preliminary design stage to the feasibility of using public road crossings for this purpose. Where not feasible, an additional structure width of 2.5 meters may be approved if designed for off-track equipment only.

[53 FR 32218, Aug. 24, 1988, as amended at 62 FR 45328, Aug. 27, 1997]

PART 650—BRIDGES, STRUCTURES, AND HYDRAULICS

Subpart A—Location and Hydraulic Design of Encroachments on Flood Plains

Sec.

- 650.101 Purpose.
- 650.103 Policy.
- 650.105 Definitions.
- 650.107 Applicability.
- 650.109 Public involvement.
- 650.111 Location hydraulic studies.
- 650.113 Only practicable alternative finding.
- 650.115 Design standards.
- 650.117 Content of design studies.

Subpart B—Erosion and Sediment Control on Highway Construction Projects

- 650.201 Purpose.
- 650.203 Policy.
- 650.205 Definitions.
- 650.207 Plans, specifications, and estimates.
- 650.209 Construction.
- 650.211 Guidelines.

Subpart C—National Bridge Inspection Standards

- 650.301 Application of standards.
- 650.303 Inspection procedures.
- 650.305 Frequency of inspections.
- 650.307 Qualifications of personnel.
- 650.309 Inspection report.
- 650.311 Inventory.

Subpart D—Highway Bridge Replacement and Rehabilitation Program

- 650.401 Purpose.
- 650.403 Definition of terms.
- 650.405 Eligible projects.
- 650.407 Application for bridge replacement or rehabilitation.
- 650.409 Evaluation of bridge inventory.
- 650.411 Procedures for bridge replacement and rehabilitation projects.
- 650.413 Funding.
- 650.415 Reports.

Subparts E-F [Reserved]

Subpart G—Discretionary Bridge Candidate Rating Factor

- 650.701 Purpose.
- 650.703 Eligible projects.
- 650.705 Application for discretionary bridge funds.
- 650.707 Rating factor.
- 650.709 Special considerations.

Title 23: Highways

PART 655—TRAFFIC OPERATIONS

Section Contents

[Subparts A–E \[Reserved\]](#)

[Subpart F—Traffic Control Devices on Federal-Aid and Other Streets and Highways](#)

[§ 655.601 Purpose.](#)

[§ 655.602 Definitions.](#)

[§ 655.603 Standards.](#)

[§ 655.604 Achieving basic uniformity.](#)

[§ 655.605 Project procedures.](#)

[§ 655.606 Higher cost materials.](#)

[§ 655.607 Funding.](#)

[Appendix to Subpart F of Part 655—Alternate Method of Determining the Color of Retroreflective Sign Materials and Pavement Marking Materials](#)

[Subpart G \[Reserved\]](#)

Authority: 23 U.S.C. 101(a), 104, 109(d), 114(a), 217, 315, and 402(a); 23 CFR 1.32; and 49 CFR 1.48(b).

Subparts A–E [Reserved]

[↑ top](#)

Subpart F—Traffic Control Devices on Federal-Aid and Other Streets and Highways

[↑ top](#)

Source: 48 FR 46776, Oct. 14, 1983, unless otherwise noted.

§ 655.601 Purpose.

[↑ top](#)

To prescribe the policies and procedures of the Federal Highway Administration (FHWA) to obtain basic uniformity of traffic control devices on all streets and highways in accordance with the following references that are approved by the FHWA for application on Federal-aid projects:

(a) Manual on Uniform Traffic Control Devices for Streets and Highways (MUTCD), 2009 Edition, FHWA, dated November 4, 2009. This publication is incorporated by reference in accordance with 5 U.S.C. 552(a) and 1 CFR part 51 and is on file at the National Archives and Records Administration (NARA). For information on the availability of this material at NARA call (202) 741-6030, or go to http://www.archives.gov/Federal_register/code_of_Federal_regulations/ibr_locations.html. It is available for inspection and copying at the Federal Highway Administration, 1200 New Jersey Avenue, SE., Washington, DC 20590, telephone 202-366-1993, as provided in 49 CFR part 7. The text is also available from the FHWA Office of Operations Web site at: <http://mutcd.fhwa.dot.gov>.

(b) Guide to Metric Conversion, AASHTO, 1993. This publication is incorporated by reference in accordance with 5 U.S.C. 552(a) and 1 CFR part 51 and is on file at the National Archives and Records Administration (NARA). For information on the availability of this material at NARA, call 202-741-6030, or go to: http://www.archives.gov/federal_register/code_of_federal_regulations/ibr_locations.html. This document is available for inspection as provided in 49 CFR part 7. It may be purchased from the American Association of State Highway and Transportation Officials, Suite 249, 444 North Capitol Street, NW., Washington, DC 20001.

(c) Traffic Engineering Metric Conversion Factors, 1993—Addendum to the Guide to Metric Conversion, AASHTO, October 1993. This publication is incorporated by reference in accordance with 5 U.S.C. 552(a) and 1 CFR part 51 and is on file at the National Archives and Records Administration (NARA). For information on the availability of this material at NARA, call 202-741-6030, or go to: http://www.archives.gov/federal_register/code_of_federal_regulations/ibr_locations.html. This document is available for inspection as provided in 49 CFR part 7. It may be purchased from the American Association of State Highway and Transportation Officials, Suite 249, 444 North Capitol Street, NW., Washington, DC 20001.

[51 FR 16834, May 7, 1986, as amended at 60 FR 18521, Apr. 11, 1995; 61 FR 29626, June 11, 1996; 62 FR 1373, Jan. 9, 1997; 63 FR 8351, Feb. 19, 1998; 63 FR 33549, June 19, 1998; 64 FR 33753, June 24, 1999; 65 FR 13, Jan. 3, 2000; 65 FR 78958, Dec. 18, 2000; 69 FR 18803, Apr. 9, 2004; 71 FR 75115, Dec. 14, 2006; 72 FR 72582, Dec. 21, 2007; 74 FR 66861, Dec. 16, 2009]

§ 655.602 Definitions.



The terms used herein are defined in accordance with definitions and usages contained in the MUTCD and 23 U.S.C. 101(a).

§ 655.603 Standards.



(a) *National MUTCD*. The MUTCD approved by the Federal Highway Administrator is the national standard for all traffic control devices installed on any street, highway, or bicycle trail open to public travel in accordance with 23 U.S.C. 109(d) and 402(a). For the purpose of MUTCD applicability, open to public travel includes toll roads and roads within shopping centers, airports, sports arenas, and other similar business and/or recreation facilities that are privately owned but where the public is allowed to travel without access restrictions. Except for gated toll roads, roads within private gated properties where access is restricted at all times are not included in this definition. Parking areas, driving aisles within parking areas, and private highway-rail grade crossings are also not included in this definition.

(b) *State or other Federal MUTCD*. (1) Where State or other Federal agency MUTCDs or supplements are required, they shall be in substantial conformance with the National MUTCD. Substantial conformance means that the State MUTCD or supplement shall conform as a minimum to the standard statements included in the National MUTCD. The FHWA Division Administrators and Associate Administrator for the Federal Lands Highway Program may grant exceptions in cases where a State MUTCD or supplement cannot conform to standard statements in the National MUTCD because of the requirements of a specific State law that was in effect prior to the effective date of this final rule, provided that the Division Administrator or Associate Administrator determines based on information available and documentation received from the State that the non-conformance does not create a safety concern. The guidance statements contained in the National MUTCD shall also be in the State Manual or supplement unless the reason for not including it is satisfactorily explained based on engineering judgment, specific conflicting State law, or

a documented engineering study. The FHWA Division Administrators shall approve the State MUTCDs and supplements that are in substantial conformance with the National MUTCD. The FHWA Associate Administrator of the Federal Lands Highway Program shall approve other Federal land management agencies MUTCDs and supplements that are in substantial conformance with the National MUTCD. The FHWA Division Administrators and the FHWA Associate Administrators for the Federal Lands Highway Program have the flexibility to determine on a case-by-case basis the degree of variation allowed.

(2) States and other Federal agencies are encouraged to adopt the National MUTCD in its entirety as their official Manual on Uniform Traffic Control Devices.

(3) States and other Federal agencies shall adopt changes issued by the FHWA to the National MUTCD within two years from the effective date of the final rule. For those States that automatically adopt the MUTCD immediately upon the effective date of the latest edition or revision of the MUTCD, the FHWA Division Administrators have the flexibility to allow these States to install certain devices from existing inventory or previously approved construction plans that comply with the previous MUTCD during the two-year adoption period.

(c) *Color specifications.* Color determinations and specifications of sign and pavement marking materials shall conform to requirements of the FHWA Color Tolerance Charts.¹ An alternate method of determining the color of retroreflective sign material is provided in the appendix.

¹ Available for inspection from the Office of Traffic Operations, Federal Highway Administration, 1200 New Jersey Avenue, SE., Washington, DC.

(d) *Compliance* —(1) *Existing highways*. Each State, in cooperation with its political subdivisions, and Federal agency shall have a program as required by 23 U.S.C. 402(a), which shall include provisions for the systematic upgrading of substandard traffic control devices and for the installation of needed devices to achieve conformity with the MUTCD. The FHWA may establish target dates of achieving compliance with changes to specific devices in the MUTCD.

(2) *New or reconstructed highways.* Federal-aid projects for the construction, reconstruction, resurfacing, restoration, or rehabilitation of streets and highways shall not be opened to the public for unrestricted use until all appropriate traffic control devices, either temporary or permanent, are installed and functioning properly. Both temporary and permanent devices shall conform to the MUTCD.

(3) *Construction area activities.* All traffic control devices installed in construction areas using Federal-aid funds shall conform to the MUTCD. Traffic control plans for handling traffic and pedestrians in construction zones and for protection of workers shall conform to the requirements of 23 CFR part 630, subpart J, Traffic Safety in Highway and Street Work Zones.

[48 FR 46776, Oct. 14, 1983, as amended at 51 FR 16834, May 7, 1986; 68 FR 14139, Mar. 24, 2003; 71 FR 75115, Dec. 14, 2006; 74 FR 28442, June 16, 2009; 74 FR 66861, Dec. 16, 2009]

§ 655.604 Achieving basic uniformity.

 [top](#)

(a) *Programs.* Programs for the orderly and systematic upgrading of existing traffic control devices or the installation of needed traffic control devices on or off the Federal-aid system should be based on inventories made in accordance with the Highway Safety Program Guideline 21, "Roadway Safety." These inventories provide the information necessary for programming traffic control device upgrading projects.

(b) *Inventory.* An inventory of all traffic control devices is recommended in the Highway Safety Program Guideline 21, "Roadway Safety." Highway planning and research funds and highway related safety grant program funds may be used in statewide or systemwide studies or inventories. Also, metropolitan planning (PL) funds may be used in urbanized areas provided the activity is included in an approved unified work program.

[48 FR 46776, Oct. 14, 1983, as amended at 71 FR 75115, Dec. 14, 2006]

§ 655.605 Project procedures.

 [top](#)

(a) *Federal-aid highways.* Federal-aid projects involving the installation of traffic control devices shall follow procedures as established in 23 CFR part 630, subpart A, Federal-Aid Programs Approval and Project Authorization. Simplified and timesaving procedures are to be used to the extent permitted by existing policy.

(b) *Off-system highways.* Certain federally funded programs are available for installation of traffic control devices on streets and highways that are not on the Federal-aid system. The procedures used in these programs may vary from project to project but, essentially, the guidelines set forth herein should be used.

§ 655.606 Higher cost materials.

 [top](#)

The use of signing, pavement marking, and signal materials (or equipment) having distinctive performance characteristics, but costing more than other materials (or equipment) commonly used may be approved by the FHWA Division Administrator when the specific use proposed is considered to be in the public interest.

§ 655.607 Funding.

 [top](#)

(a) *Federal-aid highways.* (1) Funds apportioned or allocated under 23 U.S.C. 104(b) are eligible to participate in projects to install traffic control devices in accordance with the MUTCD on newly constructed, reconstructed, resurfaced, restored, or rehabilitated highways, or on existing highways when this work is classified as construction in accordance with 23 U.S.C. 101(a). Federal-aid highway funds for eligible pavement markings and traffic control signalization may amount to 100 percent of the construction cost. Federal-aid highway funds apportioned or allocated under other sections of 23 U.S.C. are eligible for participation in improvements conforming to the MUTCD in accordance with the provisions of applicable program regulations and directives.

(2) Traffic control devices are eligible, in keeping with paragraph (a)(1) of this section, provided that the work is classified as construction in accordance with 23 U.S.C. 101(a) and the State or local agency has a policy acceptable to the FHWA Division Administrator for selecting traffic control devices material or equipment based on items such as cost, traffic volumes, safety, and expected service life. The State's policy should provide for cost-effective selection of materials which will provide for substantial service life taking into account expected and necessary routine maintenance. For these purposes, effectiveness would normally be measured in terms of durability, service life and/or performance of the material. Specific projects including material or equipment selection shall be developed in accordance with this policy. Proposed work may be approved on a project-by-project basis when the work is (i) clearly warranted, (ii) on a Federal-aid system, (iii) clearly identified by site, (iv) substantial in nature, and (v) of sufficient magnitude at any given location to warrant Federal-aid participation as a construction item.

(3) The method of accomplishing the work will be in accordance with 23 CFR part 635, subpart A, Contract Procedures.

(b) *Off-system highways.* Certain Federal-aid highway funds are eligible to participate in traffic control device improvement projects on off-system highways. In addition, Federal-aid highway funds apportioned or allocated in 23 U.S.C. are eligible for the installation of traffic control devices on any public road not on the Federal-aid system when the installation is directly related to a traffic improvement project on a Federal-aid system route.

Appendix to Subpart F of Part 655—Alternate Method of Determining the Color of Retroreflective Sign Materials and Pavement Marking Materials

 [top](#)

1. Although the FHWA Color Tolerance Charts depreciate the use of spectrophotometers or accurate tristimulus colorimeters for measuring the daytime color of retroreflective materials, recent testing has determined that 0/45 or 45/0 spectroradiometers and tristimulus colorimeters have proved that the measurements can be considered reliable and may be used.

2. The daytime color of non-fluorescent retroreflective materials may be measured in accordance with ASTM Test Method E1349, "Standard Test Method for Reflectance Factor and Color by Spectrophotometry Using Bidirectional Geometry" or ASTM Test Method E 1347 (Replaces E97), "Standard Test Method for Color and Color-Difference Measurement by Tristimulus (Filter) Colorimetry." The latter test method specified bidirectional geometry for the measurement of retroreflective materials. The geometric conditions to be used in both test methods are 0/45 or 45/0 circumferential illumination or viewing. Uniplanar geometry is not recommended for material types IV or higher (designated microprismatic). The CIE standard illuminant used in computing the colorimetric coordinates shall be D₆₅ and the 2 Degree Standard CIE observer shall be used.

3. For fluorescent retroreflective materials ASTM E991 may be used to determine the chromaticity provided that the D₆₅ illumination meets the requirements of E 991. This practice, however, allows only the total luminous factor to be measured. The fluorescent luminous factor must be determined using bispectral fluorescent colorimetry. Commercial instruments are available which allow such determination. Some testing laboratories are also equipped to perform these measurements.

4. For nighttime measurements CIE Standard Illuminant A shall be used in computing the colorimetric coordinates and the 2 Degree Standard CIE Observer shall be used.

5. Average performance sheeting is identified as Types I and II sheeting and high performance sheeting is identified as Type III. Super-high intensity sheeting is identified as Types V, VI, and VII in ASTM D 4956.

6. The following nine tables depict the 1931 CIE Chromaticity Diagram x and y coordinates for the corner points defining the recommended color boxes in the diagram and the daytime luminance factors for those colors. Lines drawn between these corner points specify the limits of the chromaticity allowed in the 1931 Chromaticity Diagram. Color coordinates of samples that lie within these lines are acceptable. For blue and green colors the spectrum locus is the defining limit between the corner points located on the spectrum locus:

Table 1 to Appendix to Part 655, Subpart F—Daytime Color Specification Limits for Retroreflective Material With CIE 2° Standard Observer and 45/0 (0/45) Geometry and CIE Standard Illuminant D₆₅.

Color	Chromaticity Coordinates							
	1		2		3		4	
	x	y	x	y	y	x	x	y
White	0.303	0.300	0.368	0.366	0.340	0.393	0.274	0.329
Red	0.648	0.351	0.735	0.265	0.629	0.281	0.565	0.346
Orange	0.558	0.352	0.636	0.364	0.570	0.429	0.506	0.404
Brown	0.430	0.340	0.430	0.390	0.518	0.434	0.570	0.382
Yellow	0.498	0.412	0.557	0.442	0.479	0.520	0.438	0.472
Green	0.026	0.399	0.166	0.364	0.286	0.446	0.207	0.771
Blue	0.078	0.171	0.150	0.220	0.210	0.160	0.137	0.038
Light Blue	0.180	0.260	0.240	0.300	0.270	0.260	0.230	0.200
Purple	0.302	0.064	0.310	0.210	0.380	0.255	0.468	0.140

Table 1a to Appendix to Part 655, Subpart F—Daytime Luminance Factors (%) for Retroreflective Material With CIE 2° Standard Observer and 45/0 (0/45) Geometry and CIE Standard Illuminant D₆₅.

Color	Daytime Luminance Factor (Y %) by ASTM Type					
	Types I, II, III and VI		Types IV, VII, and VIII		Type V	
	Minimum	Maximum	Minimum	Maximum	Minimum	Maximum
White	27		40		15	
Red	2.5	12	3.0	15	2.5	11
Orange	14	30	12	30	7.0	25
Brown	4.0	9.0	1.0	6.0	1.0	9.0
Yellow	15	45	24	45	12	30
Green	3.0	9.0	3.0	12	2.5	11
Blue	1.0	10	1.0	10	1.0	10
Light Blue	12	40	18	40	8.0	25
Purple	2.0	10	2.0	10	2.0	10

Table 2 to Appendix to Part 655, Subpart F—Nighttime Color Specification Limits for Retroreflective Material With CIE 2° Standard Observer and Observation Angle of 0.33°, Entrance Angle of +5° and CIE Standard Illuminant A.

Color	Chromaticity Coordinates							
	1		2		3		4	
	x	y	x	y	x	y	x	y
White	0.475	0.452	0.360	0.415	0.392	0.370	0.515	0.409
Red	0.650	0.348	0.620	0.348	0.712	0.2550	0.735	0.265
Orange	0.595	0.405	0.565	0.405	0.613	0.355	0.643	0.355
Brown	0.595	0.405	0.540	0.405	0.570	0.365	0.643	0.355
Yellow	0.513	0.487	0.500	0.4700	0.545	0.425	0.572	0.425
Green	0.007	0.570	0.200	0.500	0.322	0.590	0.193	0.782
Blue	0.033	0.370	0.180	0.370	0.230	0.240	0.091	0.133
Purple	0.355	0.088	0.385	0.288	0.500	0.350	0.635	0.221
Light Blue	Chromaticity coordinates are yet to be determined.							

Note: Materials used as High-Conspicuity, Retroreflective Traffic Signage Materials shall meet the requirements for Daytime Color Specification Limits, Daytime Luminance Factors and Nighttime Color Specification Limits for Fluorescent Retroreflective Material, as described in Tables 3, 3a, and 4, throughout the service life of the sign.

Table 3 to Appendix to Part 655, Subpart F—Daytime Color Specification Limits for Fluorescent Retroreflective Material with CIE 2° Standard Observer and 45/0 (0/45) Geometry and CIE Standard Illuminant D₆₅.

Color	Chromaticity Coordinates							
	1		2		3		4	
	x	y	x	y	x	y	x	y
Fluorescent Orange	0.583	0.416	0.535	0.400	0.595	0.351	0.645	0.355
Fluorescent Yellow	0.479	0.520	0.446	0.483	0.512	0.421	0.557	0.442
Fluorescent Yellow-Green	0.387	0.610	0.369	.546	.428	.496	0.460	0.540
Fluorescent Green	0.210	0.770	0.232	0.656	0.320	0.590	0.320	0.675
Fluorescent Pink	0.450	0.270	0.590	0.350	0.644	0.290	0.536	0.230
Fluorescent Red	0.666	0.334	0.613	0.333	0.671	0.275	9.735	0.265

Table 3a to Appendix to Part 655, Subpart F—Daytime Luminance Factors (%) for Fluorescent Retroreflective Material With CIE 2° Standard Observer and 45/0 (0/45) Geometry and CIE Standard Illuminant D₆₅.

Color	Luminance Factor Limits (Y)		
	Min	Max	Y _F *
Fluorescent Orange	25	None	15
Fluorescent Yellow	45	None	20
Fluorescent Yellow-Green	60	None	20
Fluorescent Green	20	30	12
Fluorescent Pink	25	None	15
Fluorescent Red	20	30	15

*Fluorescence luminance factors (YF) are typical values, and are provided for quality assurance purposes only. YF shall not be used as a measure of performance during service.

Table 4 to Appendix to Part 655, Subpart F—Nighttime Color Specification Limits for Fluorescent Retroreflective Material With CIE 2° Standard Observer and Observation Angle of 0.33°, Entrance Angle of +5° and CIE Standard Illuminant A.

Color	Chromaticity Coordinates			
	1	2	3	4

	x	y	x	y	x	y	x	y
Fluorescent Orange	0.625	0.375	0.589	0.376	0.636	0.330	0.669	0.331
Fluorescent Yellow	0.554	0.445	0.526	0.437	0.569	0.394	0.610	0.390
Fluorescent Yellow-Green	0.480	0.520	0.473	0.490	0.523	0.440	0.550	0.449
Fluorescent Green	0.007	0.570	0.200	0.500	0.322	0.590	0.193	0.782
Fluorescent Red	0.680	0.320	0.645	0.320	0.712	0.253	0.735	0.265

Table 5 to Appendix to Part 655, Subpart F—Daytime Color Specification Limits for Retroreflective Pavement Marking Material With CIE 2° Standard Observer and 45/0 (0/45) Geometry and CIE Standard Illuminant D₆₅.

Color	Chromaticity Coordinates							
	1		2		3		4	
	x	y	x	y	x	y	x	y
White	0.355	0.355	0.305	0.305	0.285	0.325	0.335	0.375
Yellow	0.560	0.440	0.490	0.510	0.420	0.440	0.460	0.400
Red	0.480	0.300	0.690	0.315	0.620	0.380	0.480	0.360
Blue	0.105	0.100	0.220	0.180	0.200	0.260	0.060	0.220
Purple	0.300	0.064	0.309	0.260	0.362	0.295	0.475	0.144

Table 5a to Part 655, Subpart F—Daytime Luminance Factors (%) for Retroreflective Pavement Marking Material With CIE 2° Standard Observer and 45/0 (0/45) Geometry and CIE Standard Illuminant D₆₅.

Color	Luminance Factor (Y%)	
	Minimum	Maximum
White	35	
Yellow	25	
Red	6	15
Blue	5	14
Purple	5	15

Table 6 to Appendix to Part 655, Subpart F—Nighttime Color Specification Limits for Retroreflective Pavement Marking Material With CIE 2° Standard Observer, Observation Angle of 1.05°, Entrance Angle of +88.76° and CIE Standard Illuminant A.

Color	Chromaticity Coordinates
--------------	---------------------------------

	1		2		3		4	
	x	y	x	y	x	y	x	y
White	0.480	0.410	0.430	0.380	0.405	0.405	0.455	0.435
Yellow	0.575	0.425	0.508	0.415	0.473	0.453	0.510	0.490
Purple	0.338	0.080	0.425	0.365	0.470	0.385	0.635	0.221

Note: Luminance factors for retroreflective pavement marking materials are for materials as they are intended to be used. For paint products, that means inclusion of glass beads and/or other retroreflective components.

[67 FR 49572, July 31, 2002, as amended at 67 FR 70163, Nov. 21, 2002; 68 FR 65582, 65583, Nov. 20, 2003; 74 FR 66862, 66863, Dec. 16, 2009]

Editorial Note: At 74 FR 66862, Dec. 16, 2009, the appendix to subpart F was amended in Table 3 by revising the daytime chromaticity coordinates for the color Fluorescent Pink; however, the amendment could not be incorporated due to inaccurate amendatory instruction.

Subpart G [Reserved]



Federal Register

**Friday,
April 29, 2005**

Part IV

Department of Transportation

Federal Transit Administration

49 CFR Part 659

**Rail Fixed Guideway Systems; State Safety
Oversight; Final Rule**

DEPARTMENT OF TRANSPORTATION**Federal Transit Administration****49 CFR Part 659**

[Docket No. FTA-2004-17196]

RIN 2132-AA76

Rail Fixed Guideway Systems; State Safety Oversight**AGENCY:** Federal Transit Administration (FTA), DOT.**ACTION:** Final rule.

SUMMARY: The Federal Transit Administration is revising its rule on state safety oversight of rail fixed guideway systems not regulated by the Federal Railroad Administration (FRA). Since January 26, 1996, when the rule took effect, the agency has gained experience and insight concerning the benefits of and recommended practices for implementing state safety oversight requirements. This final rule revises the State Safety Oversight rule and adds clarifying sections, further specification concerning what the state must require to monitor safety and security of non-FRA rail systems, and incorporates into the body of the regulation material previously incorporated by reference. The revised part should be easier to understand and ensure greater compliance of the State oversight agencies, and enhance the safety and security of the rail systems governed by this part.

DATES: The effective date of this rule is May 31, 2005. The compliance date of this rule is May 1, 2006.

FOR FURTHER INFORMATION CONTACT: For program issues, Jerry A. Fisher or Roy Field, Office of Safety and Security, Federal Transit Administration, (202) 366-2896 (telephone) or (202) 366-3394 (fax). For legal issues, Richard Wong, Office of Chief Counsel, Federal Transit Administration, (202) 366-4011.

SUPPLEMENTARY INFORMATION:**Availability of the Final Rule**

You may download this rule and other safety rules from the FTA Office of Safety and Security home page at <http://transit-safety.volpe.dot.gov>. The rule may also be downloaded from the Government Printing Office's **Federal Register** Main Page at <http://www.gpoaccess.gov/fr/index.html>. Users may download an electronic copy of this document using a modem and suitable communications software from the GPO Electronic Bulletin Board Service at (202) 512-1661. To access all comments received by the U.S. DOT Dockets, Room PL-401, refer to the

Dockets Management System (DMS) on the DOT home page at <http://dms.dot.gov>. The DMS is available 24 hours each day, 365 days each year. Follow the online instructions for more information.

Outline of Preamble

- I. Background
- II. Purpose
- III. Rulemaking Overview/Summary of Rule Changes
- IV. Overview of the Comments
- V. Section by Section Discussion of Public Comments
 - General Comments
 - Definitions
 - Withholding of Funds for Noncompliance
 - Designation of Oversight Agency
 - Confidentiality of Investigation Reports and Security Plans
 - Oversight Agency Program Standard
 - System Safety Program Plan
 - System Security Plan
 - Rail Transit Agency Review of its System Safety Program Plan
 - Rail Transit Agency Internal Safety and Security Review
 - Oversight Agency Safety and Security Review
 - Hazard Management Process
 - Accident
 - Corrective Action Plans
 - Oversight Agency Reporting to the Federal Transit Administration
 - Conflict of Interest
- VI. Section-by-Section Final Rule Analysis
- VII. Distribution and Derivation Tables
- VIII. Regulatory Process Matters
 - Executive Order 12866
 - Departmental Significance
 - Regulatory Flexibility Act
 - Unfunded Mandates Reform Act of 1995
 - Executive Order 13132 (Federalism Assessment)
 - Paperwork Reduction Act
 - List of Subjects

I. Background

This document adopts as final a new part 659, Rail Fixed Guideway Systems; State Safety Oversight. This preamble to the final rule contains a brief regulatory and program background about FTA's state safety oversight program. It also summarizes the final rule provisions, and discusses in detail the comments received on the proposed rule. We also include in the preamble a section by section description of the regulation. This is important, because, as discussed in the proposed rule, we have changed the organization of the rule to enhance usability. As a further aid, we are publishing at the end of this preamble, distribution and derivation tables, which track where old sections are in the revised part 659 and, conversely, the old section from which the new part 659 sections are derived.

The preamble to a proposed rule typically contains more detailed

information than the final rule, because it lays out in detail the provisions to aid public comment. This is true for this proposed and final rule as well, but we have included a level of information in today's **Federal Register** document that will provide a cogent explanation of the intent and provisions of the program.

Regulatory Background. In 1991, Congress required for the first time that the Federal Transit Administration (FTA) establish a program providing for the State-conducted oversight of the safety and security of rail systems not regulated by the Federal Railroad Administration (FRA). (See Intermodal Surface Transportation Efficiency Act of 1991, Pub. L. 102-240, Sec. 3029, also codified at 49 U.S.C. 5330.) FTA published its final rule adopting a new part 659, Rail Fixed Guideway Systems; State Safety Oversight, on December 27, 1995 (60 FR 67034). The final rule went into effect January 26, 1996.

For reasons described in the next section of this preamble, the agency determined that improvements could be made to part 659. Accordingly, on March 9, 2004, FTA published a Notice of Proposed Rulemaking (NPRM) proposing changes to its state safety oversight rule contained in 49 CFR part 659. Today's document contains the final rule, making changes to the substance and format of the existing part 659. These changes are detailed later in this preamble.

Program Background. When FTA issued its final rule in 1995, only five (5) states maintained provisions for safety oversight of rail transit agencies. Today, twenty-six (26) state oversight agencies have developed and implemented state safety oversight programs affecting forty-four (44) rail fixed guideway systems. It is projected that over the next decade, an additional four (4) state oversight agencies and as many as twelve (12) new starts rail transit systems may be affected by part 659.

Since part 659 created a community of oversight agencies where previously few existed, the initial goal of the rulemaking was to ensure that states were provided with sufficient authority to establish programs that met the rule's statutory requirements. Now, after eight years of experience in implementing part 659 and evaluating its performance, FTA has identified changes that will improve the program. Today's final rule addresses many of these changes.

Since the beginning of the state safety oversight program, FTA has maintained outreach with a variety of groups, including the affected states, rail transit agencies, our DOT sister agency, FRA, the National Transportation Safety Board (NTSB), and the American Public

Transportation Association (APTA). In addition, FTA has instituted a regulatory compliance program to ensure compliance with the rule's provisions. Since the program went into effect, FTA has received several recommendations concerning possible program improvements, and has taken these recommendations into consideration in the development of the final rule.

For example, the final rule clarifies the role of the state oversight agency and the role of the rail transit provider. We have done this by reorganizing the regulation and including more complete descriptions of the responsibilities of the state, the state oversight agency, and what the state oversight agency must require of the rail transit property. The final rule also includes a new definition of hazard and contains a separate section on a hazard management plan.

In addition, in September 2002, the NTSB issued recommendations to FTA (R-02-18 and -19). NTSB stated that the *APTA Manual*, published on August 20, 1991, does "not contain the necessary specific guidance for assessing the effectiveness of rules compliance programs; as a result, the guidelines are not effective tools for regulatory authorities or transit agencies." The NTSB recommended that rail transit agencies adopt, in their system safety program plans, specific standards covering rules compliance and efficiency testing programs for operations and maintenance personnel. NTSB also recommended to APTA that it update its *Manual* to address this concern and that FTA adopt the updated *APTA Manual*.

APTA may choose to update its *Manual*. However, to provide a more user-friendly regulation, the FTA determined that it is in the interest of our users to publish all of the provisions of the *APTA Manual* in the state safety oversight regulation. By eliminating a reference to the *APTA manual* in the regulation, and listing all requirements in full, this allows FTA to respond to changed circumstances and subsequent recommendations from NTSB directly through the rulemaking process. This listing also provides greater usability of the regulations, since all of the requirements are printed in one place.

II. Purpose

This rule is published to improve the performance of the State Safety Oversight Program and to ensure the following outcomes: (1) Enhance program efficiency; (2) increase responsiveness to recommendations from the NTSB and emerging safety and security issues; (3) improve consistency

in the collection and analysis of accident causal factors through increased coordination with other Federal reporting and investigation programs; and (4) improve performance of the hazard management process. The rule also clarifies FTA's oversight management objectives, and streamlines current reporting requirements, including the change from paper reporting to electronic reporting. Finally, the rule addresses heightened concerns for rail transit security and emergency preparedness.

III. Rulemaking Overview/Summary of Rule Changes

FTA amended several sections of the State Safety Oversight rule. These changes are summarized below, according to their effect on state, oversight agency, rail transit agency, and FTA roles and responsibilities.

The State

Under this rule, the primary responsibility of the state remains designating an entity—other than the rail transit agency—to oversee the safety and security of a rail fixed guideway system. If a rail fixed guideway system operates in more than one state, each state may designate an entity as the oversight agency or may agree to designate one agency from one state to provide oversight. In either case, this rule requires that in all circumstances in which a rail fixed guideway system is operating in multiple states, the rail transit agency operating the rail fixed guideway system must be subject to only one program standard.

In addition, an affected state's designation of its oversight agency must now either coincide with the execution of any New Starts project grant agreement between FTA and the rail fixed guideway system within the state's jurisdiction, or occur before the application for funding under FTA's formula program for urbanized areas (49 U.S.C. 5307) by an entity meeting the definition of rail fixed guideway system.

Within sixty (60) days of designating the oversight agency, the state must make its designation submission to FTA. A state that has already designated an oversight agency before the implementation of this rule does not need to re-designate. Should a state change its designated oversight agency, it must submit its proposed designation to FTA for review and approval within thirty (30) days of its change. After FTA approves the oversight agency designation, the designated oversight agency must provide its initial submission within thirty (30) days of receiving FTA's approval.

The state may prohibit public disclosure of investigation reports. Furthermore, states are not required to make available the rail transit agency's security plan or referenced procedures. If states cannot protect rail transit agency security plans or supporting procedures from public disclosure, then the state must review these documents on-site at the rail transit agency.

The Oversight Agency

This rule identifies the minimum requirements for the oversight agency's development of its program standard and the rail transit agency's development of its system safety program plan and security plan. In the previous regulation some of these standards were contained in the *APTA Manual*, which was incorporated by reference into the regulation.

Each oversight agency must require the rail transit agency to develop and maintain a separate system safety program plan and system security plan that complies with the oversight agency's program standard and requirements specified in this part. The oversight agency must still require the rail transit agency to conduct internal safety and security audits.

The oversight agency must review and approve the rail transit agency's annual report, documenting rail transit agency internal safety and security audit findings. The rule also requires the oversight agency to oversee an annual review by the rail transit agency of its system safety program plan and system security plan to determine whether or not either plan must be modified or updated. The oversight agency must review and approve any modification or update.

The oversight agency must require the rail transit agency to develop a hazard management process as part of its system safety program plan, to be reviewed and approved by the oversight agency. The oversight agency must require the rail transit agency to develop, in coordination with the oversight agency, thresholds for the notification and reporting of hazards to the oversight agency. Measures to eliminate or control hazards and the associated corrective actions are to be managed through the hazard management process, including rail transit agency procedures for providing the oversight agency with reports to track mitigation.

FTA has modified the thresholds for the notification and investigation of accidents. The oversight agency must require rail transit agencies to report the occurrence of accidents within two (2) hours. In those instances where the rail

transit agency shares track with the general railroad system and is subject to FRA notification requirements, the rail transit agency must notify the oversight agency within two (2) hours of an incident for which FRA is notified.

The oversight agency must investigate—or cause to be investigated—all accidents meeting the notification and investigation thresholds. The oversight agency must review and approve all procedures—except those used by the NTSB—that will be used to conduct an investigation on its behalf. Should the oversight agency not accept the rail transit agency's investigation report, it must either conduct its own investigation or prepare its own report with the amended findings. If the NTSB investigates an accident, the oversight agency remains responsible for the development of the accident report and corrective actions. It may adopt, in whole or in part, NTSB's report and findings, just as it may adopt, in whole or in part, the rail transit agency's investigation report and findings.

The oversight agency must require the rail transit agency to develop corrective action plans to address findings from accidents and the oversight agency's three-year safety and security review. In the case of accident investigations, the oversight agency is responsible for ensuring that a corrective action plan is developed, implemented, and tracked, regardless of the entity that conducts the investigation on the oversight agency's behalf. Should the NTSB conduct the accident investigation, the oversight agency must identify a process for evaluating NTSB findings to determine whether or not corrective actions should be implemented. The oversight agency must also identify a dispute resolution process for corrective action plan implementation, should the rail transit agency disagree with the oversight agency.

The oversight agency must still submit three types of reports to FTA: the initial submission, annual reports, and periodic reports. The initial submission must be delivered to FTA not later than sixty (60) days prior to the commencement of passenger operations for any New Starts system. All designated oversight agencies must provide FTA with an initial submission by the rule's date of effectiveness. An oversight agency designated after the rule's date of effectiveness must make its initial submission by the date specified in its designation submission, but no later than sixty (60) days prior to the commencement of passenger operations. In the event a state changes its oversight agency, the initial

submission is due within thirty (30) days of the new designation. The initial submission must include the oversight agency program standard, all referenced procedures, and certification that the rail transit agency system safety program plan and the system security plan have been developed, reviewed, and approved by the oversight agency.

Annual reports must summarize oversight activities for the preceding twelve (12) months, including: a description of the causal factors of investigated accidents and status of corrective actions, updates, and modifications to rail transit agency program documentation; a report that documents findings from three-year safety review activities, whether or not a three-year safety review has been completed since the last annual report was submitted; a description of the program standard and supporting procedures, if they have changed during the preceding year; and certification that any changes or modifications to the rail transit agency system safety program plan or system security plan have been reviewed and approved by the oversight agency.

FTA may request periodic reports from the oversight agency. All three types of reports must be submitted electronically to FTA.

The oversight agency must ensure that there is no conflict of interest by either the oversight agency or an entity operating on its behalf in providing oversight activities required in this rule.

Rail Transit Agency

FTA added the definition of "rail transit agency" as the agency responsible for operating the rail fixed guideway system. FTA modified the definition of "rail fixed guideway system" to ensure that states, their designated oversight agencies, and rail transit agencies have completed applicable requirements prior to the start of passenger operations.

The rail transit agency is still required to develop a system safety program plan and security plan that complies with the oversight agency's program standard and the minimum requirements specified in this rule. However, the two documents must be developed and maintained separately. The rail transit agency must review its system safety program plan and security plan annually. If either the system safety program plan or security plan must be modified, the rail transit agency must submit the modified plan to the oversight agency for review and approval.

The rail transit agency must ensure that all elements of its system safety

program and security plan are reviewed in an ongoing manner over a three-year cycle, in accordance with internal audit requirements. The rail transit agency must provide the oversight agency at least thirty (30) days notice prior to the conduct of scheduled internal safety and security reviews. The rail transit agency must also submit to the oversight agency checklists and procedures to be used in conducting the reviews. The rail transit agency's chief executive must submit a statement of compliance or noncompliance with its system safety program plan or security plan, along with the rail transit agency's annual report, to the oversight agency. If the rail transit agency is in noncompliance, the report must identify the areas that do not conform to the rail transit agency's system safety program plan, and must list measures being taken to bring these areas into compliance.

The rail transit agency must develop and implement a hazard management process that includes, at a minimum, a definition of the rail transit agency's approach to the hazard management and resolution process, a list of the sources and mechanisms used to support the ongoing identification of hazards, the process by which identified hazards will be evaluated and prioritized for elimination or control, the mechanism used to track identified hazards to resolution, the minimum thresholds for notification and reporting hazards to the oversight agency, and the process for ongoing reporting of hazard resolution activities to the oversight agency.

The rail transit agency must notify the oversight agency within two (2) hours of accidents in a format defined by the oversight agency. The rail transit agency must provide verification that corrective actions to address the finding(s) from an accident investigation are implemented as described in a corrective action plan, or must propose an alternative action(s) to be implemented subject to oversight agency review and approval. The rail transit agency must provide periodic reports as requested by the oversight agency detailing the status of corrective action implementation.

Federal Transit Administration

The FTA will continue to evaluate whether states have complied with the rule or have made adequate efforts to comply with it. This rule directs FTA to approve state designation submittals, oversight agency initial submissions, and oversight agency annual submissions. FTA retains the authority to request periodic submissions from oversight agencies.

IV. Overview of the Comments

FTA received eighteen (18) comments in response to the NPRM. FTA considered all comments filed. The breakdown among commenter categories is as follows:

State DOTs	7
Transit Agencies	6
Public Utilities	2
Trade Associations	2
States	1

Our evaluation of the comments did not lead to substantial changes between the NPRM and this Final Rule. In Section V below, we discuss in detail the public comments addressing issues raised in the NPRM.

V. Section by Section Discussion of the Comments

General Comments

Historically, states have raised concern over the lack of Federal funding to assist them in the development and implementation of safety and security oversight programs. In response to FTA's NPRM, several commenters addressed the issue of what the states term an "unfunded mandate."

Two commenters stated that the proposed rule would increase the burden on the states to perform oversight without providing any funding. These commenters noted that the proposed increase in workload is beyond their current state funding levels. One of the commenters suggested that safety oversight could be monitored and enforced through FTA's Triennial Review Process instead of through the states. One commenter noted that FTA makes funds available to support the development of the oversight program. The commenter recommended that "FTA provide funding for all capital projects includ[ing] monies to the [oversight agency] for the significant additional costs of safety and security certification." One commenter suggested that FTA identify ways to minimize the information collection burden without reducing the quality of the collected information.

Finally, one commenter suggested that the rule should take into account typical state funding cycles in relation to the schedule for implementing corrective actions.

FTA Response. For purposes of required analysis under Federal law applicable to Federal agencies, as discussed in Part VI of this preamble, this rule does not constitute an "unfunded mandate." FTA has attempted to identify Federal funding sources to support state safety oversight. For states with New Starts projects,

capital grant monies may be used for the initial development of state oversight agencies. However, neither operating nor capital grants can be used to support existing oversight agencies once passenger service commences.

FTA provides technical assistance to state oversight agencies under development or in existence in an effort to effectively promote safety and security in the rail transit environment and to reduce the learning curve of a state new to the program. The rule makes allowances for state funding cycles and corrective action implementation dates. The implementation cycle of corrective actions continues to be a local issue, and schedules for the implementation of corrective actions should be decided by the rail transit agency, with appropriate state oversight, taking into consideration the funds available to implement the corrective actions. FTA believes that the rule allows the rail transit agency and oversight agency to identify an appropriate schedule for corrective action implementation.

Definitions

One commenter recommended changing the definition of "hazard" to "hazard means any real or potential conditions," rather than just stating "hazard means any condition." The commenter recommended that FTA clearly define the context of real or potential condition. Two commenters suggested that FTA replace the phrase "hazardous condition" with "hazard."

One commenter suggested including a definition of "medical attention" (a term used in § 659.33) and "first aid." Three commenters suggested that definitions should be included for "damage to a system" and "damage to the environment," terms used in the definition of "hazard." These commenters suggested that the terms be quantifiable.

A few commenters suggested that FTA either remove the definition of "rail transit-controlled property" or limit its applicability to only areas that support operations, including revenue facilities.

A few commenters also suggested that changes be made to the definition of "individual." The comments ranged from deleting the term to modifying the definition to make it less restrictive. Two commenters recommended that the definition on "passenger" include "patron" to address persons who have just used or intend to use the rail transit system.

One commenter requested that the rule include the definition of "security breach." Finally, one commenter

recommended that the rule define "qualified professional."

FTA Response. FTA believes that a Federal standard defining the real or potential condition for which a rail transit agency must mitigate as a hazard oversteps the intent of this rule. The rule's definition of hazard currently allows management and safety representatives from the rail transit agency—with approval by the oversight agency and potential review by FTA—the opportunity to identify and define the "real or potential condition" for which the rail transit agency must mitigate to a level that is acceptable by management and the state oversight agency.

In response to commenters recommending the replacement of "hazardous condition" with "hazard," FTA concurs and has made this change throughout the rule.

FTA does not agree with the recommendation by the commenter to remove the definition of "rail transit-controlled property." It is important to maintain consistency within FTA's data collection programs, specifically state safety oversight and the National Transit Database (NTD). Furthermore, through its definition of rail transit-controlled property, FTA expects that safety or security incidents occurring on property controlled by the rail transit agency that meet the accident notification thresholds must be reported to the oversight agency. We believe that the rail transit agency's hazard identification process should include all incidents that occur on its property, regardless of whether or not the activity supports revenue operations.

FTA has chosen to keep the definition of "individual," but add the term "person" to the definition to ensure that anyone involved in an accident, meeting the thresholds specified in the notification and investigation sections, is covered by this part. This includes "pedestrians" and "others," as specified in the NTD.

FTA does not believe it is appropriate to identify each type of medical attention that an individual could receive as a result of an accident, to support notification and investigation thresholds. The rule is clear that if two or more individuals receive immediate medical attention away from the scene, the incident qualifies as an accident under § 659.33 and § 659.35. FTA's intent is to capture serious events and believes that even if the injuries sustained by two or more individuals were minor, the accident itself, regardless of the type of injury, warrants notification and investigation.

FTA believes that a detailed definition of "damage" to the system or environment is most appropriately developed by the rail transit agency, with concurrence from the state oversight agency. The threshold for damage or potential damage to the system, equipment, property or the environment should be identified during the development of the rail transit agency's hazard management process. Each property must address its operating risk in accordance with management's policy for providing standard care to the rail transit agency's passengers and employees. It is the oversight agency's responsibility to ensure that the rail transit agency's level of accepted risk meets the intent of the oversight agency's program standard and this rule, as well as conform to the rail transit agency's requirements for mitigating system hazards and their potential to cause loss.

Defining a "security breach" is similar to defining all types of accidents. Notification and investigation thresholds are determined by the impact of the accident on the rail transit passengers, employees, system, and environment. Therefore, security breaches should be reported when thresholds under § 659.33 and § 659.35 have been met.

We have not defined "qualified professional" or attempted to regulate minimum qualifications of the individuals involved at either the state oversight agency or rail transit agency level. The state and respective rail transit agency should identify and enforce the qualifications necessary to meet the requirements of this part. Finally, FTA has made a technical correction to paragraph (2) in the definition of "rail fixed guideway system" to reflect the wording of the current rule.

Withholding of Funds for Noncompliance

FTA did not propose changes to its criteria for the withholding of funds for noncompliance. A few commenters recommended that FTA extend the judgment of noncompliance to include rail transit agencies, rather than just states. The commenters noted that some states have difficulty in enforcing part 659 requirements. Two commenters recommended that FTA also identify the process by which withheld funds would be released.

FTA Response. FTA has clarified that funds will be released if the Administrator determines that an affected state has achieved compliance within two years in accordance with 49 U.S.C. 5330. We believe this provides an

adequate level of detail for what is required.

With regard to state difficulties enforcing the part 659 provisions, FTA did not make changes. States are required to ensure compliance with the provisions of this part. Under 49 U.S.C. 5330, FTA does not have the authority to regulate state policies for managing noncompliance. We believe that each state needs to identify its own enforcement mechanism.

Designation of Oversight Agency

FTA proposed changes to this section to clarify its intent about event(s) that must prompt oversight agency designation, as well as FTA's expectation that once designated the oversight agency will ensure that its program is fully implemented before the initiation of passenger service.

One commenter recommended that FTA include a provision for when a state officially moves oversight responsibility to a "new" state organization.

FTA Response. FTA has added language to this section, as well as to the initial submission element of § 659.9(f) to require a new oversight agency to submit its initial submission to FTA for review.

Confidentiality of Investigation Reports and Security Plans

FTA did not propose changes to this section.

One commenter raised concerns over past and potential problems in obtaining accident information from rail transit agencies. The commenter explained that in their state, an existing Public Records Act makes accident information available to citizens. Because of the potential release of accident information, rail transit agencies have refused to provide their investigation information and reports to the oversight agency, citing their protection by the rail transit agencies' attorney-client privilege.

One commenter recommended that security plan directives should mention other documents that should be controlled, such as drill coordination plans, training, and emergency management plans.

FTA Response. FTA understands the need for and agrees that safety and security sensitive information should remain confidential. There is no language in this regulation that requires the state or rail transit agency to release information deemed safety or security-sensitive. FTA recommends that each state identify measures to be taken to ensure that safety and security sensitive information is not publicly disclosed.

Oversight Agency Program Standard

The NPRM proposed removing the reference to the *APTA Manual* from the requirements for a state oversight agency system safety program standard. This is necessary to facilitate FTA's ability to modify or revise the minimum requirements of the program standard through the Federal regulatory process, subject to notice and public comment, rather than through the revision of an industry manual. In addition, FTA must address the role of the oversight agency in the implementation of safety and security program requirements not currently covered in the *APTA Manual*. Finally, during FTA's management of the State Safety Oversight Program, states have requested FTA to identify specific requirements that states can legislate and subsequently develop state-specific program standards that, at a minimum, meet FTA's requirements, but also allow for greater flexibility in implementation.

In its comments to the docket, APTA raised concern over FTA's proposed elimination of the *APTA Manual* reference. APTA suggested that by placing program standard element requirements in the rule, ongoing changes and revisions would be difficult to implement. In addition, APTA noted that retention of the *APTA Manual* would permit the continued transit industry and Federal government collaboration on important safety and security issues. APTA noted that by dropping the *APTA Manual* reference, there would be significant impacts on system safety, including the possibility that each state will implement these specifications differently and a national standard will not be achieved, and states will only move to meet the minimum requirements, not the intent of system safety. Finally, APTA suggested that its adoption of the system safety approach was intended to promote a self-regulatory process, a process that would be put at risk if the NPRM were to proceed as written.

One commenter suggested that FTA require the oversight agency to send a copy of its program standard to all managers of the rail transit agencies within its jurisdiction. Another commenter recommended FTA clarify the role of the oversight agency during construction and pre-revenue phases.

FTA Response. FTA has adopted the proposed rule provision. FTA does not think it is detrimental to remove the mandatory reference to the *APTA Manual* and that it is appropriate to include the program standard requirements in this rule. FTA does not believe that the rule processes

undermine system safety. The requirements in the rule for oversight agency program standard development and rail transit agency system safety program plan and security plan development is more comprehensive than the private sector standards. Additional sections have been included in the regulation to address NTSB recommendations, to strengthen the internal safety audit process, to improve coordination with the state oversight agency, and to formalize reporting requirements. By including all of the provisions in one place, it helps us meet our goals of maximizing the usability of our regulation and encouraging full compliance with its provisions. Further, this part allows for flexibility in application of safety and security principles, while maintaining the delicate balance of mandatory compliance for performance.

Federal law, 49 U.S.C. 5330, does not address the authority to be provided to states to oversee rail transit capital projects before passenger operations commence. In 1995, FTA concluded that this lack of definition prevented application of the state safety oversight rule during the planning, design, and construction of New Starts projects. However, states with New Starts projects must be in compliance with each element of part 659 before the initiation of passenger operations. To facilitate compliance, the rule requires that states make their oversight agency designation prior to a rail transit agency application for formula grant money, or at the same time as the execution of a grant agreement between FTA and the grantee applicant for a New Starts project. Furthermore, FTA requires that each state submit documentation identified in § 659.9(d) to FTA within sixty (60) days of designating its oversight agency.

FTA believes that state oversight agency participation in a project's developmental phases is critical to the success of the State Safety Oversight Program and the state's ability to provide effective oversight during operations. FTA supports states' efforts to participate during pre-operation by providing a funding mechanism through its New Starts projects process that allows capital grant monies to be used for the initial state safety oversight agency program development.

For those capital projects in states with existing rail transit agencies and safety oversight agencies and where the rail system is being modified, extended, or rehabilitated, FTA expects each oversight agency to participate in the pre-operation phases under the requirements of this part (§ 659.15 and

§ 659.19(g) and (h)), but FTA funds may not be used.

Furthermore, there is no requirement in this part that limits a state's ability to extend its safety oversight in all phases of project development. FTA encourages this practice and a handful of states currently have authority to conduct their safety and security oversight program during the planning, design and construction of a New Starts system.

System Safety Program Plan

In lieu of the *APTA Manual* reference, the NPRM laid out the minimum safety program elements from which states can ensure rail transit agencies address, as a minimum, their system safety program plans. FTA's requirements represent a minimum standard that must be addressed by each rail transit agency and enforced by the state oversight agency. The NPRM retained the requirement for state oversight agencies to review and approve a rail transit agency's system safety program plan.

One commenter requested a clarification of the meaning of "approved"—whether it meant the system safety program plan would be approved by the oversight agency or the rail transit agency. Another commenter suggested that the regulation should require a formal letter of approval from the state oversight agency, accompanied by the checklist used to review the rail transit agency's system safety program plan and security plan.

FTA received one comment proposing an "hours of service" requirement, limiting the number of hours that safety sensitive employees can work and providing a minimum number of required hours off.

Finally, two commenters suggested removing or combining specific sections of the system safety program plan minimum elements to reduce what the commenters believed to be redundant—namely removing § 659.19(s) and combining § 659.19(g) and § 659.19(r) under the heading of "System Modifications and Configuration Control."

FTA Response. The final rule requires that the oversight agency must review and approve the rail transit agency's system safety program plan.

Furthermore, this section requires that the oversight agency, using a checklist developed by the oversight agency, review the rail transit agency's system safety program plan against the requirements of this Part, in addition to the state's own program standard. FTA recommends that oversight agencies have sufficient authority to carry out their role; this includes the

responsibility for the review and approval of rail transit agency safety and security plans. FTA intends that oversight agencies include in their review and approval process the rail transit agency's operating and maintenance procedures, rulebook, and special orders.

FTA proposed, and maintains, that the oversight agency issue a formal letter of approval to the rail transit agency after reviewing the system safety program plan and security plan. FTA agrees with the commenter that the oversight agency should include in its formal submittal to the rail transit agency the checklist used to conduct the system safety program plan and security plan review.

FTA did not propose an "hours of service" requirement in this part. FTA does not have the authority to regulate in this area.

System Security Plan

The NPRM proposed minimum requirements for an agency security plan that must be maintained as a separate document.

One commenter recommended that security breaches and other security issues such as threat and vulnerability assessments should be covered similarly to safety issues. Another commenter recommended that FTA modify the security audit requirement so that such audits are conducted periodically and by qualified professionals.

One commenter suggested that the rule require a security plan that includes a description of a positive ID program identifying all contractors, visitors and employees requiring access to the system or facilities, and tracks all security related IDs, uniforms, or equipment that may be used as part of the positive ID program.

Finally, two commenters recommended that FTA not require the oversight agency to conduct an "on-site" review of the rail transit agency security plan.

FTA Response. While FTA has not provided the same level of detail relating to the security management processes identified by the commenter, rail transit agencies are required to notify and investigate security breaches that meet the accident notification and investigation thresholds in § 659.33 and 35.

While FTA agrees with the importance of positive ID programs and other access control measures to enhance security at rail transit systems, FTA does not intend that this rule specify the type of security strategy to be used by the rail transit agency and monitored by the state oversight agency.

Conversely, there is no language in this rule that prevents a rail transit agency from using such a strategy and, as noted above, FTA encourages rail transit agencies to monitor access to key areas of the rail system.

In the NPRM "Section-by-Section Analysis" FTA proposed that the oversight agency conduct its review of the rail transit agency's security plan on-site at the rail transit agency. FTA agrees with the commenters who suggested that this requirement places an unnecessary burden on the oversight agencies in the conduct of their review. Therefore, we have modified the Final Rule to require that the rail transit agency must submit its security plan to the oversight agency if the state has established protocols to protect the security plan from public disclosure. If the state cannot provide these protections, the oversight agency must review the security plan on-site at the rail transit agency. Finally, FTA intends that state oversight agencies always identify in-house representatives or contract personnel whose qualifications are sufficient to review a rail transit agency's system safety program plan and security plan.

Rail Transit Agency Review of its System Safety Program Plan

The NPRM proposed a requirement for the oversight agency to require the rail transit agency to conduct an annual review of its safety and security plans.

One commenter requested clarification regarding the level of system modification that would require resubmission of the rail transit agency's system safety program plan.

FTA Response. It is the responsibility of the state oversight agency to develop the criteria for which rail transit agency system modifications prompt the resubmission and consequent review of the system safety program plan.

Rail Transit Agency Internal Safety and Security Reviews

FTA proposed a section that requires the oversight agency to require the rail transit agency to develop and document a process for performing on-going internal safety and security reviews.

A commenter recommended FTA require a rail transit agency general manager to sign off on all conducted internal safety and security audits to ensure management is aware of internal operations and processes, and that they are effective. Three commenters voiced concern over outstanding issues at time of certification, suggesting that the requirement of the rail transit agency's general manager to certify compliance in its annual report does not address the

instance when a rail transit agency may not be in full compliance with its system safety program plan, but is still required to certify as such. One of these commenters proposed specific language indicating certification by the agency's chief executive officer.

Another commenter requested that FTA shorten the time period requirement for notifying state oversight agencies of internal safety audits from 30 days to 10 days. Three commenters recommended lengthening the time requirement for notifying state oversight agencies of scheduled internal safety audits, 45 days and 60 days. Finally, one commenter suggested that the internal safety audit process not be "reset" to coincide with the implementation of the new rule, inasmuch as certain transit operators might currently be dealing with safety issues in the midst of their audit cycles.

FTA Response. We believe that the § 659.27 proposal that a certification of compliance issued by the rail transit agency general manager or executive director be included with the annual report compiled by the rail transit agency, documenting its internal safety audit activities, addresses the commenter's request for general management endorsement. FTA also agrees that the general manager should not be required to certify compliance if internal safety audits have identified areas of noncompliance. Consequently, FTA has added the condition that in those cases where the rail transit agency is not in compliance with its system safety program plan—or security plan—the chief executive must identify those areas of noncompliance for the oversight agency, accompanied with a list of activities the rail transit agency will take to achieve compliance.

We have not reduced the timeframe for rail transit agency notification to the state before the conduct of internal safety audits from at least thirty (30) days to ten (10) days. Internal safety audits are the means by which a rail transit agency can assess effectiveness of its own safety program and how well it is being implemented agency-wide. A rail transit agency must be able to develop a schedule for these audits and make the schedule available to its oversight agency thirty (30) days before conducting the internal review. Other commenters requested the timeframe be expanded to forty-five (45) or sixty (60) days. FTA believes that thirty (30) days is sufficient for oversight agency notification since the oversight agency is not required—but strongly encouraged—to participate in the internal safety review process.

FTA agrees with the last commenter and will not require the internal safety audits to be "reset." Instead, the rail transit agency should continue its cycle of audits in compliance with all other terms of this rule, regardless of the date this rule goes into effect. It should be noted, however, that any changes to internal safety audit procedures or processes as the result of this rule must be implemented at the date this rule goes into effect.

Oversight Agency Safety and Security Reviews

FTA proposed that the oversight agency must conduct an on-site review of the rail transit agency's safety and security plans every three years or in an on-going manner.

One commenter requested that the regulation outline what should be included in the state oversight agency safety and security review report. Another commenter recommended that the proposed rule be amended to clarify that the state oversight agency reserves the right to conduct an on-site review more frequently than every three years. This commenter also recommended adding the following language, "[t]he oversight agency must prepare and issue a report containing findings, recommendations, corrective actions, and the rail transit agency's response to each finding that requires additional action. The rail transit agency's response shall set a time frame to implement the corrective actions resulting from the review. The report, at a minimum, must include an analysis of the efficacy of the system safety program plan and a determination of whether it should be updated."

FTA Response. The oversight agency should be able to determine the extent of its three-year safety reviews, to effectively evaluate rail transit agency compliance with state safety oversight requirements. FTA has shared checklists with oversight agencies and will continue to facilitate information exchange and coordination within the community. Many states have slightly different requirements within their respective program standards. However, FTA disagrees that this part should identify each element of the safety or security review since it could limit oversight agencies in their approach to the three-year safety review.

There is no language in this requirement that precludes the oversight agency from establishing the right to conduct an on-site review of the rail transit agency more frequently than every three years. FTA agrees that the reviews may be conducted in an "ongoing manner."

FTA disagrees with the commenter that additional language is needed to address oversight findings from the three-year safety or security review. Section 659.37 requires that rail transit agencies develop corrective action plans to address three-year review findings. Subsequently, the corrective actions must be implemented and tracked according to § 659.37 requirements.

Hazard Management Process

FTA proposed that each rail transit agency develop and implement a hazard management process that has been reviewed and approved by the state oversight agency. Two comments were received. One commenter agreed with FTA's process while another recommended that FTA delete the hazard management process section and make reference to it only in the proposed § 659.13 (system safety program standard) in the NPRM.

FTA Response. We disagree with the commenter who suggested referencing the hazard management process solely in the system safety program standard section. The hazard management process is central to system safety and warrants its own section within this rule.

Accident Notification and Investigation

In the NPRM, FTA proposed revisions to the definition of accident to provide greater consistency with the notification and investigation requirements used by the NTSB as well as reporting thresholds established by FTA's NTD. Further, FTA proposed defining accident in relation to the activities required by the rail transit agency and oversight agency after the occurrence of an event deemed an accident. FTA proposed in the NPRM that the oversight agency must require the rail transit agency to notify the oversight agency within two (2) hours of any event involving a rail transit vehicle or taking place on rail transit-controlled property where one or more of the following occurs:

(1) A fatality, where an individual is confirmed dead within thirty (30) days of a transit-related incident, excluding suicides and deaths from illness;

(2) Injuries requiring immediate medical attention away from the scene for two or more individuals;

(3) Property damage to rail transit vehicles, non-rail transit vehicles, other rail transit property or facilities that equals or exceeds \$25,000;

(4) An evacuation due to life safety reasons; or

(5) A main-line derailment.

In addition the oversight agency must require rail transit agencies that share

track with the general railroad system and are subject to the Federal Railroad Administration notification requirements to notify the oversight agency within two (2) hours of an incident for which the rail transit agency must notify the Federal Railroad Administration.

A majority of the commenters addressed the definition or thresholds for accident notification and investigation in several ways. Two commenters suggested that the two-hour notification requirement adds an unreasonable burden on the rail transit agency, especially during a catastrophic event, and recommended that FTA change the time period to four hours. One commenter recommended that FTA further define what constitutes "notification," questioning whether or not an individual from the state oversight agency should be required to be available to receive the notification twenty-four (24) hours a day, seven (7) days a week or if it is sufficient that a message is left or fax is sent within the two (2) hour window. The commenter suggested that this might influence state resource allocation.

Several commenters expressed concern over the definition of fatality, noting that a fatality may be difficult to "[confirm] within thirty (30) days of a transit incident," given increased constraints on retrieving patient information due to the Health Insurance Portability and Accountability Act of 1996 (HIPAA). A few commenters suggested that the 30-day confirmation period should be removed, while one commenter suggested it be reduced to twenty-four (24) hours.

Several commenters recommended that state oversight agencies be notified of all fatalities, including suicides. Several of these commenters noted that the determination of cause of death might not be made within the first two hours after the incident. Other commenters noted that FRA and NTSB do not make distinctions between a fatality and a suicide, and that a situation may occur where the NTSB or FRA may be notified of a fatality but the state oversight agency would not.

Relating to the notification threshold for injuries, some commenters recommended that FTA maintain the current definition, which requires notification by the rail transit agency when an incident occurs resulting in a single injury instead of "two or more persons" in the NPRM. These commenters suggested that under FTA's proposed threshold for injury, an incident in which a person is struck by a train and is transported to the hospital would not be reported to the oversight

agency. One commenter also noted that FTA's NTD requires the reporting of one person injured in a collision occurring on a rail right-of-way. Other commenters suggested that while the NPRM attempted to align definitions with NTD, in some areas conflicts remain.

Several commenters objected to the reduction in the property damage threshold from \$100,000 in the current rule to \$25,000 in the NPRM. Many of these commenters indicated that in lowering the threshold, rail transit agencies and state oversight agencies would face an unnecessary increase in notifications, and there would be an increased burden in investigating and tracking these accidents. Most commenters recommended that FTA maintain the \$100,000 property damage notification threshold. One commenter suggested that the qualification of property damage to only "rail transit vehicles, non-rail transit vehicles, [or] other rail transit property or facilities" limits applicable items, and that since the current rule includes all property damage and provides the necessary information, it should be retained.

Several commenters proposed that FTA either delete the definition of individual for threshold purposes, or make it broader to ensure that pedestrians are included. Another commenter suggested that the term "person" be used, as no fatality should go unreported.

Some commenters recommended that FTA either add a definition for "medical attention" or clarify the term "injury," to clarify that the intent of the rule is not to require immediate notification for very minor items.

Some commenters objected to the proposed location of the incident "involving a rail transit vehicle or taking place on rail transit-controlled property," suggesting that FTA should limit the requirement for notification to those instances where an event has occurred only when it involves the operation of the rail transit vehicle, and not in such places as offices, parking lots and other areas that do not involve rail transit operations.

In reference to requirements for accident investigation, § 659.29, FTA proposed, "[t]he oversight agency must investigate, or cause to be investigated, at a minimum, any event involving a rail transit vehicle or taking place on rail transit-controlled property meeting the fatality, injury, or property damage thresholds identified in § 659.27(a)." Relating to the threshold for investigations, one commenter suggested that the NPRM creates a large investigative workload. Some

commenters recommended that FTA also make a distinction between FTA-reportable (those meeting the fatality, injury, and property damage thresholds for notification) and non-reportable (namely, the evacuation and main-line derailment thresholds), to ensure that the non-reportable incidents are still logged, reviewed and tracked for possible identification of trends and patterns.

Additionally, the NPRM proposed, “(b) The oversight agency must use approved investigation procedures that have been submitted to FTA as required in the initial submission or annual submission” and “(c) In the event the oversight agency designates the rail transit agency to conduct investigations on its behalf, it must do so formally and require the rail transit agency to use investigation procedures that have been formally approved by the oversight agency.”

Some commenters recommended that the required investigation process for the analysis of probable or multiple causal determinations be standardized across the industry. Another commenter recommended that the state oversight agency’s procedures include the rail transit agency’s own investigation of the accident.

The NPRM proposed, “(d) Each investigation must be documented in a final report that includes a description of investigation activities, identified causal factors, and a corrective action plan. (1) The final investigation report must be submitted to the oversight agency in a format and timeframe specified by the oversight agency. (2) The oversight agency must review and formally approve each final investigation report. (3) The oversight agency shall have the authority to require periodic status reports that document investigation activities and findings in a time frame determined by the oversight agency.”

One commenter objected to the requirement for the state oversight agency to approve the rail transit agency investigation report, indicating that the investigating party must be given autonomy for findings in the final report and that any state comments should be made during the drafting phase. Another commenter suggested that the proposed rule for accident investigations relied on transparency between the agencies and that the rail transit agencies must release, or make available, all essential information to the state oversight agency in order for the state to adequately review the determination of cause(s).

Finally, one commenter recommended that FTA require sending

the final investigation report to the rail transit agency’s executive director or general manager.

FTA Response. In light of the comments submitted relating to the accident notification and investigation sections of the rule, FTA has made changes to these requirements. For instance, we will require the rail transit agency to notify an oversight agency of all fatalities, and will not exclude suicides from the notification process. We agree with those commenters who suggested that the cause of death might not be readily apparent and that it should not be the role of the rail transit agency or state oversight agency to make that determination. In addition, suicides on urban rail systems are a visible problem and the oversight agency should be notified when they occur. Safety issues may be involved in these incidents, and corrective actions could potentially prevent additional suicides.

In reference to the notification threshold for a fatality, FTA disagrees with the commenters who noted that it might be difficult to track the status of an individual for thirty (30) days to determine whether or not the individual has been confirmed dead, thus requiring notification of the state oversight agency and compliance with subsequent investigation and corrective action plan requirements. Furthermore, FTA believes that the rail transit agency’s representative(s) responsible for risk management, legal duties, or claims will either be notified of the confirmed death or will track status information. In addition, rail transit agencies must currently track this information for NTD reporting. For these reasons we did not revise the 30-day tracking period.

FTA agrees with commenters indicating that noteworthy incidents, such as a collision between a train and a person would go unreported under the notification threshold for two (2) or more injuries in the NPRM. Furthermore, we agree that there are still discrepancies between notification and investigation thresholds in the NPRM and those of the data reporting thresholds for “major events” within the NTD Program and notification thresholds for NTSB. While we believe that minor inconsistencies will remain, we have made changes to the accident notification and investigation thresholds in an effort to increase the coordination between the above stated programs. Most significantly, FTA has changed the accident notification and investigation thresholds to mirror all eight (8) NTD “Major Event” thresholds, not just the first five (5) thresholds identified in the NPRM. In addition to the five (5) thresholds identified in the NPRM, rail

transit agencies are now also required to notify state oversight agencies in the event of a mainline derailment, a collision with person(s) on a rail right-of-way, and a collision between a rail transit vehicle and another rail transit vehicle or a transit non-revenue vehicle.

We agree with several commenters who requested greater clarity for key definitions within the accident notification and investigation thresholds, namely individual and medical attention. We have more clearly identified the definition of “individual” to include pedestrians and other persons. While there are distinctions between the types of individuals, FTA intends that all persons who suffer injuries that require medical attention away from the scene of the incident or end in fatality are individuals under this rule. Historically, FTA excluded the reporting of fatalities and injuries of employees and trespassers under the State Safety Oversight Program.

FTA agrees with one commenter who recommended FTA clarify that the intent of this rule is not to require state safety oversight agency notification for very minor injuries. For consistency, the use of “immediate medical attention” in this rule should be interpreted as it is used under FTA’s NTD program. The following is an excerpt from the NTD reporting manual and clarifies FTA’s intent within this rule:

The definition of injury requires immediate medical attention away from the scene. Immediate medical attention includes, but is not limited to, transport to the hospital by ambulance. If an individual is transported immediately from the incident scene to a hospital or physician’s office by another type of emergency vehicle, by passenger vehicle, or through other means of transport, this is also considered an injury. An individual seeking medical care several hours after an incident or in the days following an incident is not considered to have received immediate medical attention. In cases that are less clear-cut, reporters should apply their judgment in determining whether the injury sustained caused the individual to immediately seek medical attention.

The medical attention received must be at a location other than the location at which the incident occurred. The intent of this distinction is to exclude incidents that only require minor first aid or other assistance received at the scene. This distinction is not, however, intended to be burdensome for the [rail] transit agency. It is not a requirement that an agency follow-up on each person transported by ambulance, for example, to ensure that they actually received medical attention at the hospital. It is acceptable to count each person immediately transported by ambulance as an injury. If, however, an agency representative does choose to follow-up with the hospital and finds that, though an individual was transported to the hospital, he did not receive any medical attention, this

individual does not need to be reported as an injury.”

We disagree with commenters suggesting that the two-hour notification requirement does not provide an adequate amount of time for the rail transit agency to notify the oversight agency, especially during catastrophic events. While we understand that a catastrophic event can overwhelm rail transit agency personnel, we believe that two (2) hours is reasonable and mirrors requirements by the NTSB, and may provide more time than the “immediate notification” required by FRA.

In reference to the format in which notifications are made and state oversight agency personnel availability, we believe that these decisions are best left to the state to identify and define. FTA believes it is reasonable to expect state oversight agency and rail transit agency representatives to identify a practical process that ensures the oversight agency is notified appropriately and can carry out subsequent activities.

We agree with commenters who noted that the qualifying of property damage as applying only to “rail transit vehicles, non-rail transit vehicles, [or] other rail transit property or facilities” limits applicable items. To clarify FTA’s intent, FTA has removed the qualifiers and requires notification when an accident equals or exceeds \$25,000 in total accident damage. Consistent with NTD and NTSB requirements, property damage to both transit and non-transit property should be included in the estimate. While many commenters objected to the reduction in the property damage threshold, we believe that the \$25,000 notification and investigation threshold is appropriate and reflects the current requirements of the NTSB.

FTA disagrees with recommendations to constrain the applicability of the accident notification and investigation thresholds to only those incidents “involving the operation of a transit vehicle,” ignoring incidents that occur in parking lots, stations, and other areas of rail transit property and responsibility. We believe that this rule limits notification and investigation to only the most serious events that might occur on rail transit property. As such, we believe that in accordance with the intent of state safety oversight, these events should be reported to the state in a timely manner to ensure the state’s ability to investigate and require corrective actions, as required under Section 5330 of the enabling legislation. Furthermore, FTA has interpreted the state safety oversight legislation to

include security considerations. In so doing, FTA requires the rail transit agency to report security incidents that meet the notification thresholds to the oversight agency. We believe that passenger safety and security are often interrelated and each passenger should expect to be free from danger, unintentional or intentional, to the extent that it is reasonably practicable. As such, we believe that efforts by the rail transit agency, in accordance with state oversight, should be applied system-wide and not limited to only specific passenger or vehicle operations.

As mentioned above, accident investigation thresholds have been changed to accurately reflect thresholds identified in the NTD major event category. FTA disagrees with the commenter who suggested that the NPRM creates a large investigative workload. Under the old definition of accident, states were required to investigate all single person events in which an individual was treated for injuries away from the scene (the majority of these events were slips, trips and falls in transit stations and vehicles). The new accident investigation thresholds actually lessen the investigative burden by only requiring investigation of single person events in which there has been a train/person collision or a collision between a rail transit vehicle and another rail transit vehicle or a transit non-revenue vehicle. Some commenters expressed concern over the exclusion of all single person events meeting the injury threshold under the old rule. FTA requires this threshold to be identified in the hazard management process developed by the rail transit agency. We believe that an effective identification process within a hazard management resolution program would include single person events as a source for hazards or potential hazards. We believe that the changes are necessary to capture incidents with serious consequences. FTA acknowledges that while one set of thresholds will not necessarily accommodate different modal considerations or state and local resource allocation and burden, they support our intent to standardize the reporting and investigation of accident causal factors and mitigating activities, and allow us to identify proactive activities that prevent fatalities, serious injury and major system loss. Finally, we believe it is imperative that oversight agencies are notified of accidents within a timeframe consistent with that of the NTSB notification requirement.

FTA has clarified the investigation reporting requirements to ensure that rail transit agency investigation reports

maintain their autonomy, while assuring the state’s right to conduct its own investigation. However, FTA kept the requirement for state oversight agencies to review and approve corrective action plans.

With reference to the requirements for state approval of investigation reports, FTA agrees with the commenter recommendation to not require such approval. FTA did not intend the state oversight agency to formally review and approve the rail transit agency’s investigation report. In those instances where the oversight agency has authorized the rail transit agency to conduct an investigation on its behalf, FTA intends that the oversight agency review and approve the report for the oversight agency’s own internal process, not for the rail transit agency. This investigation report is now the responsibility of the oversight agency, which must either formally approve it or amend the report prior to adopting it as its final investigation report.

FTA also allows the oversight agency to contract for this service and/or allow the rail transit agency to conduct some of the investigations. For each accident that meets the investigation thresholds, the oversight agency must approve the investigation report. They must also require the rail transit agency to develop corrective action plans to address accident findings. These plans must then be reviewed and approved by the oversight agency. In addition, the oversight agency must establish a process to resolve any disagreements in the event that the two agencies cannot reach an agreement on the corrective action plan.

FTA disagrees with the recommendation to require the submission of the final investigation report to the rail transit agency’s chief executive. While FTA encourages inter and intra-agency communication and coordination, we did not specify the distribution list for the final investigation report. However, there is no language in this part that limits the rail transit agency safety manager from providing the chief executive with a copy of the investigation report, and FTA encourages this level of intra-agency coordination.

Finally, FTA recommends that rail transit agencies and oversight agencies develop investigation procedures and apply them consistently. However, FTA did not require standardization of the investigation process across the industry as some commenters recommended. We believe that there are different, yet equally effective, methods of conducting accident investigations. Furthermore, we believe it is the responsibility of rail

transit agencies and their state oversight agency counterparts to determine which investigative methodology is most effective.

Corrective Action Plans

FTA proposed that oversight agencies review and formally approve corrective action plans.

Two commenters recommended that FTA should not require state oversight agencies to approve corrective action plans. Three commenters suggested that FTA require corrective actions plans be developed after safety and security internal audits and any annual reviews that may be performed by the rail transit agency.

One commenter proposed a clarification change in the language from “* * * its process for the review and approval of a corrective action plan,” to “* * * the Transit Agency’s process for the review and approval of the corrective action plan.”

FTA Response. FTA disagrees with commenters who suggested that FTA not require oversight agency review and approval. Given that oversight agency approval is only necessary for corrective actions developed resulting from three-year safety and security reviews and the results from accident investigations, FTA believes that oversight agency participation is not intrusive or overbearing. State oversight agencies are required by the enabling legislation to investigate and approve corrective actions, and FTA believes that an independent assessment of the developed corrective actions not only meets the intent of safety oversight, but also provides the necessary objectivity to ensure that rail transit agencies have prioritized safety and security activities to meet the most critical and pressing needs.

FTA also disagrees with the commenters that recommend developing corrective action plans to address findings from rail transit agency internal audits. FTA believes that some level of autonomy is necessary when the rail transit agency conducts its own internal safety and security audit process. We recommend that the state oversight agency work with the rail transit agency to identify the criteria for which findings from internal safety and security audits are subject to the hazard identification and subsequent resolution process.

Oversight Agency Reporting to the Federal Transit Administration

One commenter suggested spreading the reporting requirements specified in the NPRM over a two-year period so that states operating under a deficit are not

unnecessarily burdened. Two commenters requested that FTA allow a minimum one-year grace period to states for implementation of new regulations. One of these commenters went on to recommend that the rule identify the records required to be maintained and specify the required retention periods.

One commenter recommended that the rule explicitly specify the requirements of the initial submission, including its program standard, procedures or process for reviewing and approving the rail transit agencies’ system safety program plans, investigatory procedures, and criteria for the development of the rail transit agencies’ corrective action plans to correct, eliminate, minimize or control investigated hazardous conditions. The commenter went on to recommend that the rule explicitly name the types of periodic submissions that FTA may request.

Three commenters suggested that the rule provide a list of any records that must be maintained by the oversight agency and specify the required retention periods. Two of those commenters stated that the rule should also provide the same information for transit agencies.

Finally, one commenter suggested that reporting requirements were too burdensome to states and FTA should identify a mechanism to improve the effectiveness of annual reporting without affecting the quality of reporting.

FTA Response. FTA asked commenters to make recommendations in reference to the timeframe for requiring initial submissions, once the state safety oversight rule takes effect. Two commenters recommended providing one year from the rule’s date of effectiveness to achieve compliance. One commenter suggested that one year may be too ambitious and requested that states be allowed extensions if needed, due to legislation issues. FTA agrees and will allow one year from the rule’s date of effectiveness for states to comply with rule requirements. However, in those cases where state legislatures may only meet once every two years, FTA may entertain an exception to the compliance date. FTA will address this subject through future guidance.

FTA expects that each oversight agency will submit its entire program standard and all program procedures developed to support the oversight activities required by this rule. This includes all procedures associated with the oversight agency’s implementation of its program identified in § 659.19 and each procedure that requires action by

the oversight agency. FTA disagrees that we should identify every procedure to be submitted and believes that it is not necessary to burden the rule with what may be redundant requirements, without greater justification.

While one commenter presented an exhaustive list of information FTA may request as part of a periodic submission, FTA believes it is unnecessary to identify each potential submission in the text of the rule. Instead, FTA will identify needed material on a case-by-case basis and work with the oversight agency to obtain needed material. Similarly, FTA decided not to identify records that the oversight agency should maintain. We believe that the oversight agency should maintain the necessary records for the effective development, management, and implementation of its oversight duties.

FTA is requiring electronic data collection for oversight agency reporting. FTA agrees that the quality of information collected is of the greatest importance.

Conflict of Interest

The NPRM proposed that the oversight agency must prohibit a party or entity from providing services to both the oversight agency and the rail transit agency, when a conflict of interest exists.

A few commenters suggested that FTA either define conflict of interest in the rule, or provide a clarification of the scope of services to be performed by a contractor. One commenter also suggested that this might limit the number of contractors eligible to compete for proposals.

FTA Response. The intent of state safety oversight is to establish an independent agency to oversee the implementation of safety and security programs by the rail transit agency. The independent agency must adhere to the requirements in this rule and ensure that any rail transit agency within its jurisdiction also adheres to these requirements. FTA believes that the state designated agency must function without prejudice; this extends to procuring a contractor to perform oversight activities. The selected contractor must be able to perform its duties on behalf of the state with the same level of impartiality, without conflict of interest. FTA believes it is in the best interest of the State Safety Oversight Program to take steps to ensure that contractors can effectively perform their duties without bias. FTA also believes that each state is in a better position to define the conflict of interest provisions necessary to meet the intent

of state safety oversight while contracting for services.

VI. Section-by-Section Analysis

Purpose (§ 659.1)

This section explains that FTA is implementing the requirements of 49 U.S.C. 5330, which requires a state to establish an agency to oversee the safety of rail fixed guideway systems. This rule directs the oversight agency to develop a program standard, including a security element, and to require the rail transit agency to develop a security plan and a separate system safety program plan that complies with the program standard and requirements of this rule. In addition, the oversight agency must conduct safety and security reviews and ensure the conduct of accident and hazard investigations. The oversight agency must also ensure that corrective action plans are developed and implemented to address findings from accident and hazard investigations and track implementation to resolution. The oversight agency must ensure that the rail transit agency implements its system safety program plan and security plan effectively.

Scope (§ 659.3)

This section explains that the rule applies only to states with rail fixed guideway systems, as defined in this part.

Definitions (§ 659.5)

Contractor

“Contractor” means an entity that performs tasks required by this part on behalf of the oversight or “rail transit agency.” The “rail transit agency” may not be a “contractor” for the “oversight agency.”

Corrective Action Plan

“Corrective action plan” means a plan developed to set forth the actions the “rail transit agency” will take to minimize, control, correct, or eliminate “hazards,” and the schedule for implementation for those actions.

FRA

“FRA” means the Federal Railroad Administration, an agency within the U.S. Department of Transportation.

FTA

“FTA” means the Federal Transit Administration, an agency within the U.S. Department of Transportation.

Hazard

“Hazard” means any real or potential condition (as defined in the “rail transit agency’s” hazard management process)

that can cause injury, illness, or death; damage to or loss of a system, equipment or property; or damage to the environment.

Individual

“Individual” means a passenger; employee; contractor; other rail transit facility worker; pedestrian; trespasser; or any person on rail transit-controlled property.

Investigation

“Investigation” means the process used to determine the causal and contributing factors of an accident or hazard, so that actions can be identified to prevent recurrence. The oversight agency is ultimately responsible for the conduct of the investigation and the resulting findings. An investigation may be conducted by an entity acting on behalf of the oversight agency, providing the procedures to be used during the investigation have been reviewed and approved by the oversight agency and submitted to FTA. If the rail transit agency conducts the investigation on behalf of the oversight agency, the oversight agency must either adopt the findings from the investigation or successfully negotiate any disputes that result from the findings. In the event there is a dispute over investigation findings, if there is no resolution, the oversight agency must either conduct its own investigation or amend the rail transit agency findings with its opinion. There must not be conflicting corrective actions to address investigation findings.

New Starts Project

“New Starts Project” means any rail fixed guideway system funded under FTA’s 49 U.S.C. 5309 discretionary construction program.

Oversight Agency

“Oversight Agency” means the entity, other than the rail transit agency, designated by the state or several states to implement this part.

Passenger

“Passenger” means a person who is on board, boarding, or alighting from a rail transit vehicle for the purpose of travel. The intent of this definition is to make a distinction between individuals that are physically on the rail transit vehicle, or those in the process of entering or leaving the rail transit vehicle, and non-passengers such as pedestrians or trespassers as categorized under the National Transit Database (NTD).

Passenger Operations

“Passenger operations” means the period of time commencing when any aspect of rail transit agency operation is initiated with the intent to carry passengers. In the previous rule, there was confusion over the definition of revenue service; did it mean the period the agency opened its doors to the public, or simply when a passenger boarded the first rail transit vehicle of the day. In this rule, FTA uses the former definition. Once the rail transit agency initiates its first action with the intent to carry passengers, it is considered to be in passenger operations.

Program Standard

“Program standard” means a written document developed and adopted by the oversight agency, that describes the policies, objectives, responsibilities, and procedures used to provide rail transit agency safety and security oversight.

Rail Fixed Guideway System

“Rail fixed guideway system” means any light, heavy, or rapid rail system, monorail, inclined plane, funicular, trolley, or automated guideway that:

- (1) is not regulated by the Federal Railroad Administration; and
- (2) is included in FTA’s calculation of fixed guideway route miles, or receives funding under FTA’s formula program for urbanized areas (49 U.S.C. 5336); or
- (3) has submitted documentation to FTA indicating its intent to be included in FTA’s calculation of fixed guideway route miles to receive funding under FTA’s formula program for urbanized areas (49 U.S.C. 5336).

Rail Transit Agency

“Rail transit agency” means an entity that operates a rail fixed guideway system. If the grantee has contracted out operations and maintenance of the rail fixed guideway system, it maintains full accountability to ensure that all requirements identified in the oversight agency’s program standard and this rule are met.

Rail Transit-Controlled Property

“Rail transit-controlled property” means property that is used by the rail transit agency and may be owned, leased, or maintained by the rail transit agency. FTA does not distinguish between different types of rail transit-controlled property, meaning that an accident meeting the notification and investigation thresholds of this section must prompt notification of the oversight agency, regardless of where it occurred on rail transit-controlled property.

Rail Transit Vehicle

“Rail transit vehicle” means the rail transit agency’s rolling stock. This definition includes vehicles used for carrying “passengers” and providing maintenance (*i.e.*, high-rail vehicle).

Safety

“Safety” means freedom from harm resulting from unintentional acts or circumstances.

Security

“Security” means freedom from harm resulting from intentional acts or circumstances. Intentional danger includes crimes and must be reported to the oversight agency if the intentional act meets the thresholds for notification as specified in this rule.

State

“State” means a State of the United States, the District of Columbia, Puerto Rico, the Northern Mariana Islands, Guam, American Samoa, and the Virgin Islands.

System Safety Program Plan

“System safety program plan” means a document developed and adopted by the rail transit agency, describing its safety policies, objectives, responsibilities, and procedures.

System Security Plan

“System security plan” means a document developed and adopted by the rail transit agency, describing its security policies, objectives, responsibilities, and procedures. The system security plan must be a separate document from the system safety program plan.

Withholding of Funds for Noncompliance (§ 659.7)

Authority for this section is based on 49 U.S.C. 5330, which directs FTA to withhold federal funding from a state or an urbanized area in the state. FTA is authorized to withhold up to five percent of an affected urbanized area’s apportionment if FTA determines the state is not in compliance or making adequate efforts to comply with the rule. Withheld formula funds will be restored if the state is in compliance within two (2) years.

Designation of Oversight Agency (§ 659.9)

This section directs the state to select an agency to oversee the rail fixed guideway system and prohibits the state from selecting the rail transit agency to perform this role. It also prohibits the state from selecting an agency for which a conflict of interest—as determined by

FTA—exists that would prevent the oversight agency from carrying out its activities in an unbiased manner.

The rule requires that the state’s designation, at a minimum, coincides with the execution of a grant agreement between FTA and the rail transit agency for a New Starts project or prior to the application for any formula funds.

Designation means that the Governor for the affected state would identify an agency, and a point of contact from that agency who will assume oversight responsibility. Designation, for purposes of the final rule, may occur prior to the passage of enabling legislation or other activities that may be necessary for the oversight agency to assume its responsibilities for implementing part 659 requirements.

After designation, the state would have sixty (60) days to provide FTA with a designation submission, which would include: (1) Identification of the agency most likely to provide oversight; (2) a description of its current authorities relating to rail transit safety and security oversight; (3) a point of contact within the designated agency to coordinate program development with FTA; (4) identification of any potential conflicts of interest between the designated agency and the rail transit agency, based on financial or shared management responsibilities; and (5) a proposed schedule describing major milestones to ensure implementation of the state’s oversight program before the start of passenger operations at the rail transit agency.

For rail transit agencies that operate, or will operate, in more than one state, the affected states may each designate an agency of the state to implement state safety oversight requirements, or may agree to designate one agency of one state, or an agency representative of each state. After the states designate an agency, a single program standard, adopted by each state, must be developed to implement state safety oversight program requirements. This will allow the rail transit agency to develop a seamless program that is equally applicable in all affected states, rather than being burdened with requirements from two or more states.

States that have already designated an approved agency to FTA are not required to re-designate. However, if a state changes its designation, the new oversight agency must submit a new initial submission to FTA within thirty (30) days of the change, consistent with § 659.39.

Confidentiality of Investigation Reports (§ 659.11)

This section allows states to prohibit an investigation report prepared or adopted by the oversight agency from being admitted into evidence or used in a civil action. In addition, this part does not require public availability of the rail transit agency’s security plan.

Oversight Agency Overview and Program Standard (§ 659.13–15)

This rule removes the reference to the *APTA Manual* from the requirements for a State Safety Oversight Program standard. FTA has prepared a list of nine (9) elements that must be included in a program standard, including minimum requirements to address oversight agency authority and specific interfaces with the rail transit agency.

The program standard must address both safety and security and be submitted to FTA with the oversight agency’s initial submission. If the oversight agency modifies its program standard it must submit the revised version to FTA.

System Safety Program Plan (§§ 659.17–19)

The rule stipulates that the oversight agency must require the rail transit agency to develop and implement a written system safety program plan that complies with the oversight agency’s program standard. FTA has identified twenty-one (21) elements that, at a minimum, must be addressed by the rail transit agency. The rail transit agency must submit its system safety program plan—and any subsequent revisions—to the oversight agency for review and approval.

System Security Plan (§§ 659.21–23)

The rule requires that the system security plan is developed and maintained separately from the rail transit agency’s system safety program plan. FTA considers the system security plan to be sensitive information and has not established any requirements preventing the state, oversight agency, or rail transit agency from protecting the system security plan and any referenced procedures from public disclosure. The oversight agency and rail transit agency must identify a process by which the oversight agency can review and approve the system security plan without compromising sensitive information. Throughout this process, the transit system and the oversight agency must comply with all regulations relating to the non-disclosure of sensitive information in 49 CFR part 1520.

FTA, to the best of its knowledge, has not established any requirements for the system security plan that are in conflict with Department of Homeland Security (DHS) directives. The DHS is the lead Federal agency on security matters, including transportation, and FTA collaborates closely with them.

Annual Review of System Safety Program Plan and System Security Plan (§ 659.25)

The rule specifies that the oversight agency must require the rail transit agency to conduct an annual review of its system safety program plan and system security plan. This review may simply result in the determination that no update is necessary in either plan, or it may result in more substantive changes to one or both plans.

In the event that the system safety program plan is modified, the rail transit agency must submit the modified plan and any subsequently modified procedures to the oversight agency for review and approval. When the plan is approved, the oversight agency must issue a formal letter of approval to the rail transit agency.

In the event that the system security plan is modified, the rail transit agency is required to make it available to the oversight agency for review and approval. When the plan is approved, the oversight agency must issue a formal letter of approval to the rail transit agency.

Internal Safety and Security Reviews (§ 659.27)

Each rail transit agency must conduct internal safety and security reviews as described in its procedures. The rail transit agency must document this process in its system safety program plan for review and approval by the oversight agency. The rail transit agency must notify the oversight agency at least thirty (30) days before conducting a scheduled review, in a manner acceptable to the oversight agency without placing undue burden on the rail transit agency.

The internal safety and security reviews must be conducted throughout the year, with all elements to be reviewed completed within a three-year cycle. The rail transit agency must provide the oversight agency with all checklists and procedures used to conduct its safety reviews, and make available checklists and procedures for conducting security reviews, provided this does not compromise sensitive information.

The oversight agency must require the rail transit agency to submit an annual report documenting internal safety and

security review activities and the status of subsequent findings and recommendations. The security section of this report must be made available to the oversight agency in a manner that does not compromise sensitive information. The annual report must be accompanied by a formal letter of certification signed by the rail transit agency's executive director or general manager, indicating that the rail transit agency is in compliance with its system safety program plan and system security plan. In the event that the rail transit agency is not in compliance with its own system safety program plan or security plan, the rail transit agency must identify the actions it is taking to achieve compliance, including a schedule and the department that is responsible. The oversight agency must formally review and approve this report.

Oversight Agency Safety and Security Reviews (§ 659.29)

At least every three (3) years, the oversight agency must conduct an on-site review of the rail transit agency's implementation of its system safety program plan and system security plan. The rule also requires that the oversight agency prepares and issues a report containing findings and recommendations resulting from that review, which, at a minimum, must include an analysis of the effectiveness of the system safety program plan and the security plan and a determination of whether either should be updated. Based on the results of this on-site review, the oversight agency must ensure that corrective action plans are developed to address review findings.

The rail transit agency's system safety program plan and system security plan may be reviewed in an ongoing manner over the three-year timeframe, or in a comprehensive on-site review, once every three years.

Hazard Management Process (§ 659.31)

The rule requires the rail transit agency to develop a process to identify and resolve hazards during operation, system extensions, modifications, or changes (including procedural changes). This process would replace the current requirements for the notification and investigation of unacceptable hazardous conditions, and ensure that the oversight agency has an ongoing role in the rail transit agency's hazard identification and resolution process.

As part of the system safety program plan, the oversight agency must require the rail transit agency to develop a hazard management process, to be reviewed and approved by the oversight agency. This process must, at a

minimum: (1) Define the rail transit agency's approach to hazard management and the implementation of an integrated system-wide hazard resolution process; (2) specify the sources of, and the mechanisms to support, the on-going identification of hazards; (3) define the process by which identified hazards will be evaluated and prioritized for elimination or control; (4) identify the mechanism used to track to resolution the identified hazards; (5) define minimum thresholds for the notification and reporting to oversight agencies of hazards; and (6) specify the process by which the rail transit agency will provide on-going reporting of hazard resolution activities to the oversight agency.

Accident Notification (§ 659.33)

The oversight agency must require the rail transit agency to notify the oversight agency within two (2) hours of any incident involving a rail transit vehicle or taking place on rail transit-controlled property, where one or more of the following occurs:

(1) A fatality at the scene; or where an individual is confirmed dead within thirty (30) days of a rail transit-related incident;

(2) Injuries requiring immediate medical attention away from the scene for two or more individuals;

(3) Property damage to rail transit vehicles, non-rail transit vehicles, other rail transit property or facilities, and non-transit property that equals or exceeds \$25,000;

(4) An evacuation due to life safety reasons;

(5) A collision at a grade crossing;

(6) A main-line derailment;

(7) A collision with an individual on a rail right of way; or

(8) A collision between a rail transit vehicle and another rail transit vehicle or a rail transit non-revenue vehicle.

These events could take place on a rail transit vehicle or on rail transit-controlled property, and could involve rail transit passengers, employees, contractors, rail transit facility occupants, other workers, trespassers, or other persons.

For rail transit agencies that share track with the general railroad system and are subject to FRA notification requirements, the rule requires notifying the oversight agency within two (2) hours of an incident for which the rail transit agency must notify the FRA. FTA believes this is necessary to address the role of the State Safety Oversight Program in the FRA's waiver process at 49 CFR parts 209 and 211.

The rule requires that the oversight agency identify in its program standard

the information to be provided by the rail transit agency with the method of notification.

Investigations (§ 659.35)

At a minimum the oversight agency must investigate, or cause to be investigated, any incident involving a rail transit vehicle or taking place on rail transit-controlled property meeting the notification thresholds identified in the notification § 659.33(a).

These thresholds correspond closely to the thresholds required by the NTSB for rail transit agency notification of events that may be subsequently investigated by the NTSB, as well as the thresholds identified in the NTD for major incidents.

In meeting this requirement, the oversight agency must ensure that the investigation is conducted according to procedures reviewed and approved by the oversight agency and submitted to FTA. In the event the oversight agency designates the rail transit agency to conduct the investigation on its behalf, it must do so formally and require the rail transit agency to use investigation procedures that have been formally approved by the oversight agency and submitted to FTA to fulfill the oversight agency's initial or annual submission requirements.

The rule specifies that each investigation must be documented in a final report that includes a description of investigation activities, causal factors and contributing factors, and a corrective action plan. The rule provides the oversight agency with the flexibility to determine, in its program standard, when the final investigation report must be submitted to the oversight agency, the format of the final report, and whether status updates or preliminary findings should also be submitted according to a timeframe specified by the oversight agency.

The oversight agency is ultimately responsible for the investigation and the final report. The oversight agency may adopt the final report, findings, and corrective actions submitted by the rail transit agency or conduct its own investigation to determine findings. If a dispute relating to investigation findings should arise between the oversight agency and the rail transit agency, the oversight agency is responsible for resolving the dispute to ensure that corrective actions are developed to address report findings and requiring periodic status reports that document investigation activities and findings.

Corrective Action Plans (§ 659.37)

The rule consolidates all requirements for corrective action plans into a single

section. The rule specifies that the oversight agency, at a minimum, require the rail transit agency to develop a corrective action plan for the following occurrences: (1) results from investigations in which identified causal and contributing factors are determined by the rail transit agency or oversight agency as requiring corrective actions; and (2) findings from safety and security reviews performed by the oversight agency. Requirements for corrective action plan development for identified hazards are to be specified by the rail transit agency in the hazard management process.

The rule specifies that each corrective action plan must identify the action to be taken by the rail transit agency, the schedule for its implementation, and the department responsible for its implementation. The corrective action plan must be reviewed and formally approved by the oversight agency. The oversight agency is required to monitor the implementation of each approved corrective action plan.

The rule specifies that the oversight agency must require the rail transit agency to provide (1) verification that the corrective action(s) has been implemented as detailed in the corrective action plan or a proposed alternate action(s) subject to oversight agency review and approval and (2) periodic reports as requested by the oversight agency describing the status of each corrective action(s) not completely implemented as described in the corrective action plan.

Oversight Agency Report to the Federal Transit Administration (§ 659.39)

The rule requires that all submissions to FTA be made electronically. At the current time, FTA anticipates that this reporting would occur in an Internet-based format, as a secure page on FTA's existing safety and security Web site. Until the system is in place, FTA requires that annual submissions be made through electronic mail or on CD-ROM through regular mail. Oversight agencies will be notified when the Internet-based system is operational.

For initial submissions, the rule specifies that each designated oversight agency must submit to FTA: (1) oversight agency program standard and referenced procedures; and (2) certification that the system safety program plan and the system security plan have been developed, reviewed, and approved. In states with rail fixed guideway systems in passenger operations, as of the publication date of this rule, the designated oversight agency must make its initial submissions to FTA no later than one

year after the publication of the final rule. In states with rail fixed guideway systems entering passenger operations after the publication date of this rule, the designated oversight agency must make its initial submission within the time frame proposed by the state in its designation submission and approved by FTA.

This rule requires that oversight agencies make annual submissions prior to March 15 of each year using a reporting system specified by FTA. The annual submission would require the following: (1) Publicly available annual report summarizing its oversight activities for the preceding twelve months; (2) report documenting and tracking findings from three-year safety and security review activities, and whether a three-year safety or security review has been completed since the last annual report was submitted; and (3) program standard and supporting procedures that have changed during the preceding year.

Finally, FTA has the authority to request periodic submissions from oversight agencies, which may include status reports for accident investigations, hazards, and corrective action plans.

Conflict of Interest (§ 659.41)

This rule requires the oversight agency to prohibit a person or entity from providing services to both the state safety oversight agency and rail transit agency when a conflict of interest exists.

Certification of Compliance (§ 659.43)

This rule requires that each oversight agency annually certify electronically to FTA that it has complied with the requirements of the State Safety Oversight Program. The oversight agency must maintain a signed copy of each annual certification, subject to audit by FTA.

VII. Distribution and Derivation Tables

DISTRIBUTION TABLE

Old section	New section(s)
659.1	659.1
659.3	659.3
659.5	659.5
659.7	659.7
659.21	659.9
659.23	659.11
659.31	659.13 and 659.15
659.33	659.17, 659.19, and 659.21
659.23	N.A.
N.A.	659.25
659.35	659.27
659.37	659.29
659.39	659.31 and 659.33
659.41	659.35

DISTRIBUTION TABLE—Continued

Old section	New section(s)
659.43	659.37
659.45	659.39
N.A.	659.41
659.47	None
659.49	659.43

DERIVATION TABLE

New section	Old section(s)
659.1	659.1
659.3	659.3
659.5	659.5
659.7	659.7
659.9	659.21
659.11	659.23
659.13	659.31
659.15	659.31
659.17	659.33
659.19	New
659.21	659.33
659.23	New
659.25	New
659.27	659.37
659.29	659.39
659.31	New
659.33	659.39
659.35	659.41
659.37	659.43
659.39	659.45
659.41	New
659.43	659.49

estimated annual burden between years five (5) and ten (10) increased approximately 15 percent. FTA estimates the annual cost of this rule (*i.e.*, the annual cost of the entire rule as amended, as distinct from incremental costs of the proposed changes) to be approximately \$2.1 million—this represents a nearly \$800,000 increase over the previous rule. The \$800,000 difference between the previous cost of implementing the rule and the annual cost of implementing this revised rule over the next 10 years is mostly caused by continued program growth (*i.e.*, addition of seven (7) rail transit agencies and new states by the year 2013). When estimating costs for this rule, FTA increased the assumed hourly rate for personnel responsible for implementing rule requirements from \$25 per hour to \$35 per hour. This increase reflects FTA experience with the implementation of the previous rule's requirements and outreach with state and rail transit agency representatives. FTA believes that while the estimate for the annual cost burden has increased, the proposed changes will not cause the regulated parties to drastically change their behavior or substantially increase the number of resources needed to meet rule requirements.

Regulatory Flexibility Act

In accordance with the *Regulatory Flexibility Act* (Pub. L. 96-354, 5 U.S.C. 601-612), FTA has evaluated the effects of these rule changes on small entities and has determined that there will not be a significant impact on a substantial number of these entities; only larger rail transit agencies and oversight agencies (such as state departments of transportation and public utility commissions) will be affected. The original analysis for the 1995 final rule determined that there would be no significant impact on small entities. This rule merely makes modest administrative changes to the original rule. For these reasons, FTA certifies that this action will not have a significant economic impact on a substantial number of small entities.

Unfunded Mandates Reform Act of 1995

This rule will not impose unfunded mandates as defined by the *Unfunded Mandates Reform Act of 1995* (Pub. L. 104-4, March 22, 1995, 109 Stat. 48). This rule will not result in state, local, and tribal governments or the private sector incurring aggregate expenditures of \$100 million or more in any one year, adjusted for inflation (2 U.S.C. 1532). As noted above, the estimated \$2.1 million

annual cost of implementing the rule is well below this threshold.

Executive Order 13132 (Federalism Assessment)

Prior to the publication of the original State Safety Oversight rule, FTA conducted a Federalism Assessment according to the requirements of Executive Order 12612, which has since been revoked and replaced by the above-referenced order. Refer to 60 FR 67041 (December 27, 1995). Because the state safety oversight requirements are already in place, and this rule only provides more detailed requirements for greater clarification and performance-based evaluation to the existing rule, FTA has determined that Federalism impacts are minimal.

FTA has also determined that this action does not preempt any state law or state regulation or affect the states' ability to discharge traditional state governmental functions. As noted in the original analysis, there may be instances in which a state or local agency faces a conflict between compliance with this rule and state and local requirements. Because compliance with this rule is a condition of Federal financial assistance, state and local governments have the option of not seeking the Federal funds if they choose not to comply.

Paperwork Reduction Act

Under the *Paperwork Reduction Act of 1995* (PRA) (44 U.S.C. 3501, *et. seq.*), Federal agencies must obtain approval from the Office of Management and Budget (OMB) for each collection of information they conduct, sponsor, or require through regulations. This rule includes information collection requirements subject to PRA. OMB approved FTA's collection requirements in the original rule, and reviewed and approved an updated submission in November 2002 (OMB #2132-0558). Since this rule will result in additional or altered paperwork collection burdens, FTA will submit this requirement to the Office of Information and Regulatory Affairs of the OMB for review.

The estimated burden for information collection requirements is an annualized 26,502 hours and \$927,600 for oversight agencies and 33,244 hours and \$1,163,540 for rail transit agencies. These numbers relate to the burdens of the entire rule as amended, distinct from incremental burdens of the changes.

National Environmental Policy Act

FTA has analyzed this action for the purpose of compliance with the

VIII. Regulatory Process Matters

Executive Order 12866

The Office of Management and Budget (OMB) has determined that OMB review under EO 12866 is not necessary. While the economic impact of this rulemaking is not anticipated to be significant because the changes are incremental in nature, FTA recognizes that this rule affects state governments, may be of congressional interest and makes changes to important DOT policy. These changes include replacing a referenced industry manual as the guideline for program compliance with proposed minimum requirements, revised thresholds for accident notification and investigation, clarification of critical processes such as the management of hazardous conditions, and additional definitions. For these reasons, this rule is a significant regulation under the Department's Regulatory Policies and Procedures.

In 1995, FTA evaluated the industry-wide costs and benefits of part 659 before this revision. The economic analysis is available from FTA. In its analysis, FTA estimated the total costs for the first ten years to be approximately \$9.1 million. However, when factoring in projections for program growth and new starts, the

National Environmental Policy Act (42 U.S.C. 4321 *et seq.*) and has determined that this rulemaking will not have any effect on the quality of the human environment.

List of Subjects in 49 CFR Part 659

Grant Programs—Transportation, Mass Transportation, Reporting and recordkeeping requirements, Safety, Security, Transportation.

■ For the reasons described in the preamble, FTA revises part 659 to read as follows:

PART 659—RAIL FIXED GUIDEWAY SYSTEMS; STATE SAFETY OVERSIGHT

Subpart A—General Provisions

Sec.

659.1 Purpose.

659.3 Scope.

659.5 Definitions.

Subpart B—Role of the State

659.7 Withholding of funds for noncompliance.

659.9 Designation of oversight agency.

659.11 Confidentiality of investigation reports and security plans.

Subpart C—Role of the State Oversight Agency

659.13 Overview.

659.15 System safety program standard.

659.17 System safety program plan: general requirements.

659.19 System safety program plan: contents

659.21 System security plan: general requirements.

659.23 System security plan: contents.

659.25 Annual review of system safety program plan and system security plan.

659.27 Internal safety and security reviews.

659.29 Oversight agency safety and security reviews.

659.31 Hazard management process.

659.33 Accident notification.

659.35 Investigations.

659.37 Corrective action plans.

659.39 Oversight agency reporting to the Federal Transit Administration.

659.41 Conflict of interest.

659.43 Certification of compliance.

Authority: 49 U.S.C. 5330.

Subpart A—General Provisions

§ 659.1 Purpose.

This part implements 49 U.S.C. 5330 by requiring a state to oversee the safety and security of rail fixed guideway systems through a designated oversight agency.

§ 659.3 Scope.

This part applies only to states with rail fixed guideway systems, as defined in this part.

§ 659.5 Definitions.

Contractor means an entity that performs tasks required on behalf of the oversight or rail transit agency. The rail transit agency may not be a contractor for the oversight agency.

Corrective action plan means a plan developed by the rail transit agency that describes the actions the rail transit agency will take to minimize, control, correct, or eliminate hazards, and the schedule for implementing those actions.

FRA means the Federal Railroad Administration, an agency within the U.S. Department of Transportation.

FTA means the Federal Transit Administration, an agency within the U.S. Department of Transportation.

Hazard means any real or potential condition (as defined in the rail transit agency's hazard management process) that can cause injury, illness, or death; damage to or loss of a system, equipment or property; or damage to the environment.

Individual means a passenger; employee; contractor; other rail transit facility worker; pedestrian; trespasser; or any person on rail transit-controlled property.

Investigation means the process used to determine the causal and contributing factors of an accident or hazard, so that actions can be identified to prevent recurrence.

New Starts Project means any rail fixed guideway system funded under FTA's 49 U.S.C. 5309 discretionary construction program.

Oversight Agency means the entity, other than the rail transit agency, designated by the state or several states to implement this part.

Passenger means a person who is on board, boarding, or alighting from a rail transit vehicle for the purpose of travel.

Passenger Operations means the period of time when any aspect of rail transit agency operations are initiated with the intent to carry passengers.

Program Standard means a written document developed and adopted by the oversight agency, that describes the policies, objectives, responsibilities, and procedures used to provide rail transit agency safety and security oversight.

Rail Fixed Guideway System means any light, heavy, or rapid rail system, monorail, inclined plane, funicular, trolley, or automated guideway that:

- (1) Is not regulated by the Federal Railroad Administration; and
- (2) Is included in FTA's calculation of fixed guideway route miles or receives funding under FTA's formula program for urbanized areas (49 U.S.C. 5336); or
- (3) Has submitted documentation to FTA indicating its intent to be included

in FTA's calculation of fixed guideway route miles to receive funding under FTA's formula program for urbanized areas (49 U.S.C. 5336).

Rail Transit Agency means an entity that operates a rail fixed guideway system.

Rail Transit-Controlled Property means property that is used by the rail transit agency and may be owned, leased, or maintained by the rail transit agency.

Rail Transit Vehicle means the rail transit agency's rolling stock, including but not limited to passenger and maintenance vehicles.

Safety means freedom from harm resulting from unintentional acts or circumstances.

Security means freedom from harm resulting from intentional acts or circumstances.

State means a State of the United States, the District of Columbia, Puerto Rico, the Northern Mariana Islands, Guam, American Samoa, and the Virgin Islands.

System Safety Program Plan means a document developed and adopted by the rail transit agency, describing its safety policies, objectives, responsibilities, and procedures.

System Security Plan means a document developed and adopted by the rail transit agency describing its security policies, objectives, responsibilities, and procedures.

Subpart B—Role of the State

§ 659.7 Withholding of funds for noncompliance.

(a) The Administrator of the FTA may withhold up to five percent of the amount required to be distributed to any state or affected urbanized area in such state under FTA's formula program for urbanized areas, if:

(1) The state in the previous fiscal year has not met the requirements of this part; and

(2) The Administrator determines that the state is not making adequate efforts to comply with this part.

(b) The Administrator may agree to restore withheld formula funds, if compliance is achieved within two years (See 49 U.S.C. 5330).

§ 659.9 Designation of oversight agency.

(a) *General requirement.* Each state with an existing or anticipated rail fixed guideway system regulated by this part shall designate an oversight agency consistent with the provisions of this section. For a rail fixed guideway system that will operate in only one state, the state must designate an agency of the state, other than the rail transit

agency, as the oversight agency to implement the requirements in this part. The state's designation or re-designation of its oversight agency and submission of required information as specified in this section, are subject to review by FTA.

(b) *Exception.* States which have designated oversight agencies for purposes of this part before May 31, 2005 are not required to re-designate to FTA.

(c) *Timing.* The state designation of the oversight agency shall:

(1) Coincide with the execution of any grant agreement for a New Starts project between FTA and a rail transit agency within the state's jurisdiction; or

(2) Occur before the application by a rail transit agency for funding under FTA's formula program for urbanized areas (49 U.S.C. 5336).

(d) *Notification to FTA.* Within (60) days of designation of the oversight agency, the state must submit to FTA the following:

(1) The name of the oversight agency designated to implement requirements in this part;

(2) Documentation of the oversight agency's authority to provide state oversight;

(3) Contact information for the representative identified by the designated oversight agency with responsibility for oversight activities;

(4) A description of the organizational and financial relationship between the designated oversight agency and the rail transit agency; and

(5) A schedule for the designated agency's development of its State Safety Oversight Program, including the projected date of its initial submission, as required in § 659.39(a).

(e) *Multiple states.* In cases of a rail fixed guideway system that will operate in more than one state, each affected state must designate an agency of the state, other than the rail transit agency, as the oversight agency to implement the requirements in this part. To fulfill this requirement, the affected states:

(1) May agree to designate one agency of one state, or an agency representative of all states, to implement the requirements in this part; and

(2) In the event multiple states share oversight responsibility for a rail fixed guideway system, the states must ensure that the rail fixed guideway system is subject to a single program standard, adopted by all affected states.

(f) *Change of designation.* Should a state change its designated oversight agency, it shall submit the information required under paragraph (d) of this section to FTA within (30) days of its change. In addition, the new oversight

agency must submit a new initial submission, consistent with § 659.39(b), within (30) days of its designation.

§ 659.11 Confidentiality of investigation reports and security plans.

(a) A state may withhold an investigation report that may have been prepared or adopted by the oversight agency from being admitted as evidence or used in a civil action for damages resulting from a matter mentioned in the report.

(b) This part does not require public availability of the rail transit agency's security plan and any referenced procedures.

Subpart C—Role of the State Oversight Agency

§ 659.13 Overview.

The state oversight agency is responsible for establishing standards for rail safety and security practices and procedures to be used by rail transit agencies within its purview. In addition, the state oversight agency must oversee the execution of these practices and procedures, to ensure compliance with the provisions of this part. This subpart identifies and describes the various requirements for the state oversight agency.

§ 659.15 System safety program standard.

(a) *General requirement.* Each state oversight agency shall develop and distribute a program standard. The program standard is a compilation of processes and procedures that governs the conduct of the oversight program at the state oversight agency level, and provides guidance to the regulated rail transit properties concerning processes and procedures they must have in place to be in compliance with the state safety oversight program. The program standard and any referenced program procedures must be submitted to FTA as part of the initial submission. Subsequent revisions and updates must be submitted to FTA as part of the oversight agency's annual submission.

(b) *Contents.* Each oversight agency shall develop a written program standard that meets the requirements specified in this part and includes, at a minimum, the areas identified in this section.

(1) *Program management section.* This section shall include an explanation of the oversight agency's authority, policies, and roles and responsibilities for providing safety and security oversight of the rail transit agencies within its jurisdiction. This section shall provide an overview of planned activities to ensure on-going communication with each affected rail

transit agency relating to safety and security information, as well as FTA reporting requirements, including initial, annual and periodic submissions.

(2) *Program standard development section.* This section shall include a description of the oversight agency's process for the development, review, and adoption of the program standard, the modification and/or update of the program standard, and the process by which the program standard and any subsequent revisions are distributed to each affected rail transit agency.

(3) *Oversight of rail transit agency internal safety and security reviews.* This section shall specify the role of the oversight agency in overseeing the rail transit agency internal safety and security review process. This includes a description of the process used by the oversight agency to receive rail transit agency checklists and procedures and approve the rail transit agency's annual reports on findings, which must be submitted under the signature of the rail transit agency's top management.

(4) *Oversight agency safety and security review section.* This section shall lay out the process and criteria to be used at least every three years in conducting a complete review of each affected rail transit agency's implementation of its system safety program plan and system security plan. This section includes the process to be used by the affected rail transit agency and the oversight agency to manage findings and recommendations from this review. This also includes procedures for notifying the oversight agency before the rail transit agency conducts an internal review.

(5) *Accident notification section.* This section shall include the specific requirements for the rail transit agency to notify the oversight agency of accidents. This section shall also include required timeframes, methods of notification, and the information to be submitted by the rail transit agency. Additional detail on this portion is included in § 659.33 of this part.

(6) *Investigations section.* This section contains the oversight agency identification of the thresholds for incidents that require an oversight agency investigation. The roles and responsibilities for conducting investigations shall include: coordination with the rail transit agency investigation process, the role of the oversight agency in supporting investigations and findings conducted by the NTSB, review and concurrence of investigation report findings, and procedures for protecting the confidentiality of investigation reports.

(7) *Corrective actions section.* This section shall specify oversight agency criteria for the development of corrective action plan(s) and the process for the review and approval of a corrective action plan developed by the rail transit agency. This section shall also identify the oversight agency's policies for the verification and tracking of corrective action plan implementation, and its process for managing conflicts with the rail transit agency relating to investigation findings and corrective action plan development.

(8) *System safety program plan section.* This section shall specify the minimum requirements to be contained in the rail transit agency's system safety program plan. The contents of the system safety plan are discussed in more detail in § 659.19 of this part. This section shall also specify information to be included in the affected rail transit agency's system safety program plan relating to the hazard management process, including requirements for on-going communication and coordination relating to the identification, categorization, resolution, and reporting of hazards to the oversight agency. More details on the hazard management process are contained in § 659.31 of this part. This section shall also describe the process and timeframe through which the oversight agency must receive, review, and approve the rail transit agency system safety program plan.

(9) *System security plan section.* This section shall specify the minimum requirements to be included in the rail transit agency's system security plan. More details about the system security plan are contained in §§ 659.21 through 659.23 of this part. This section shall also describe the process by which the oversight agency will review and approve the rail transit agency system security program plan. This section also shall identify how the state will prevent the system security plan from public disclosure.

§ 659.17 System safety program plan: general requirements.

(a) The oversight agency shall require the rail transit agency to develop and implement a written system safety program plan that complies with requirements in this part and the oversight agency's program standard.

(b) The oversight agency shall review and approve the rail transit agency system safety program plan.

(c) After approval, the oversight agency shall issue a formal letter of approval to the rail transit agency, including the checklist used to conduct the review.

§ 659.19 System safety program plan: contents.

The system safety plan shall include, at a minimum:

(a) A policy statement signed by the agency's chief executive that endorses the safety program and describes the authority that establishes the system safety program plan.

(b) A clear definition of the goals and objectives for the safety program and stated management responsibilities to ensure they are achieved.

(c) An overview of the management structure of the rail transit agency, including:

(1) An organization chart;

(2) A description of how the safety function is integrated into the rest of the rail transit organization; and

(3) Clear identification of the lines of authority used by the rail transit agency to manage safety issues.

(d) The process used to control changes to the system safety program plan, including:

(1) Specifying an annual assessment of whether the system safety program plan should be updated; and

(2) Required coordination with the oversight agency, including timeframes for submission, revision, and approval.

(e) A description of the specific activities required to implement the system safety program, including:

(1) Tasks to be performed by the rail transit safety function, by position and management accountability, specified in matrices and/or narrative format; and

(2) Safety-related tasks to be performed by other rail transit departments, by position and management accountability, specified in matrices and/or narrative format.

(f) A description of the process used by the rail transit agency to implement its hazard management program, including activities for:

(1) Hazard identification;

(2) Hazard investigation, evaluation and analysis;

(3) Hazard control and elimination;

(4) Hazard tracking; and

(5) Requirements for on-going reporting to the oversight agency relating to hazard management activities and status.

(g) A description of the process used by the rail transit agency to ensure that safety concerns are addressed in modifications to existing systems, vehicles, and equipment, which do not require formal safety certification but which may have safety impacts.

(h) A description of the safety certification process required by the rail transit agency to ensure that safety concerns and hazards are adequately addressed prior to the initiation of

passenger operations for New Starts and subsequent major projects to extend, rehabilitate, or modify an existing system, or to replace vehicles and equipment.

(i) A description of the process used to collect, maintain, analyze, and distribute safety data, to ensure that the safety function within the rail transit organization receives the necessary information to support implementation of the system safety program.

(j) A description of the process used by the rail transit agency to perform accident notification, investigation and reporting, including:

(1) Notification thresholds for internal and external organizations;

(2) Accident investigation process and references to procedures;

(3) The process used to develop, implement, and track corrective actions that address investigation findings;

(4) Reporting to internal and external organizations; and

(5) Coordination with the oversight agency.

(k) A description of the process used by the rail transit agency to develop an approved, coordinated schedule for all emergency management program activities, which include:

(1) Meetings with external agencies;

(2) Emergency planning responsibilities and requirements;

(3) Process used to evaluate emergency preparedness, such as annual emergency field exercises;

(4) After action reports and implementation of findings;

(5) Revision and distribution of emergency response procedures;

(6) Familiarization training for public safety organizations; and

(7) Employee training.

(l) A description of the process used by the rail transit agency to ensure that planned and scheduled internal safety reviews are performed to evaluate compliance with the system safety program plan, including:

(1) Identification of departments and functions subject to review;

(2) Responsibility for scheduling reviews;

(3) Process for conducting reviews, including the development of checklists and procedures and the issuing of findings;

(4) Review of reporting requirements;

(5) Tracking the status of implemented recommendations; and

(6) Coordination with the oversight agency.

(m) A description of the process used by the rail transit agency to develop, maintain, and ensure compliance with rules and procedures having a safety impact, including:

(1) Identification of operating and maintenance rules and procedures subject to review;

(2) Techniques used to assess the implementation of operating and maintenance rules and procedures by employees, such as performance testing;

(3) Techniques used to assess the effectiveness of supervision relating to the implementation of operating and maintenance rules; and

(4) Process for documenting results and incorporating them into the hazard management program.

(n) A description of the process used for facilities and equipment safety inspections, including:

(1) Identification of the facilities and equipment subject to regular safety-related inspection and testing;

(2) Techniques used to conduct inspections and testing;

(3) Inspection schedules and procedures; and

(4) Description of how results are entered into the hazard management process.

(o) A description of the maintenance audits and inspections program, including identification of the affected facilities and equipment, maintenance cycles, documentation required, and the process for integrating identified problems into the hazard management process.

(p) A description of the training and certification program for employees and contractors, including:

(1) Categories of safety-related work requiring training and certification;

(2) A description of the training and certification program for employees and contractors in safety-related positions;

(3) Process used to maintain and access employee and contractor training records; and

(4) Process used to assess compliance with training and certification requirements.

(q) A description of the configuration management control process, including:

(1) The authority to make configuration changes;

(2) Process for making changes; and

(3) Assurances necessary for formally notifying all involved departments.

(r) A description of the safety program for employees and contractors that incorporates the applicable local, state, and federal requirements, including:

(1) Safety requirements that employees and contractors must follow when working on, or in close proximity to, rail transit agency property; and

(2) Processes for ensuring the employees and contractors know and follow the requirements.

(s) A description of the hazardous materials program, including the

process used to ensure knowledge of and compliance with program requirements.

(t) A description of the drug and alcohol program and the process used to ensure knowledge of and compliance with program requirements.

(u) A description of the measures, controls, and assurances in place to ensure that safety principles, requirements and representatives are included in the rail transit agency's procurement process.

§ 659.21 System security plan: general requirements.

(a) The oversight agency shall require the rail transit agency to implement a system security plan that, at a minimum, complies with requirements in this part and the oversight agency's program standard. The system security plan must be developed and maintained as a separate document and may not be part of the rail transit agency's system safety program plan.

(b) The oversight agency may prohibit a rail transit agency from publicly disclosing the system security plan.

(c) After approving the system security plan, the oversight agency shall issue a formal letter of approval, including the checklist used to conduct the review, to the rail transit agency.

§ 659.23 System security plan: contents.

The system security plan must, at a minimum address the following:

(a) Identify the policies, goals, and objectives for the security program endorsed by the agency's chief executive.

(b) Document the rail transit agency's process for managing threats and vulnerabilities during operations, and for major projects, extensions, new vehicles and equipment, including integration with the safety certification process;

(c) Identify controls in place that address the personal security of passengers and employees;

(d) Document the rail transit agency's process for conducting internal security reviews to evaluate compliance and measure the effectiveness of the system security plan; and

(e) Document the rail transit agency's process for making its system security plan and accompanying procedures available to the oversight agency for review and approval.

§ 659.25 Annual review of system safety program plan and system security plan.

(a) The oversight agency shall require the rail transit agency to conduct an annual review of its system safety program plan and system security plan.

(b) In the event the rail transit agency's system safety program plan is modified, the rail transit agency must submit the modified plan and any subsequently modified procedures to the oversight agency for review and approval. After the plan is approved, the oversight agency must issue a formal letter of approval to the rail transit agency.

(c) In the event the rail transit agency's system security plan is modified, the rail transit agency must make the modified system security plan and accompanying procedures available to the oversight agency for review, consistent with requirements specified in § 659.23(e) of this part. After the plan is approved, the oversight agency shall issue a formal letter of approval to the rail transit agency.

§ 659.27 Internal safety and security reviews.

(a) The oversight agency shall require the rail transit agency to develop and document a process for the performance of on-going internal safety and security reviews in its system safety program plan.

(b) The internal safety and security review process must, at a minimum:

(1) Describe the process used by the rail transit agency to determine if all identified elements of its system safety program plan and system security plan are performing as intended; and

(2) Ensure that all elements of the system safety program plan and system security plan are reviewed in an on-going manner and completed over a three-year cycle.

(c) The rail transit agency must notify the oversight agency at least thirty (30) days before the conduct of scheduled internal safety and security reviews.

(d) The rail transit agency shall submit to the oversight agency any checklists or procedures it will use during the safety portion of its review.

(e) The rail transit agency shall make available to the oversight agency any checklists or procedures subject to the security portion of its review, consistent with § 659.23(e).

(f) The oversight agency shall require the rail transit agency to annually submit a report documenting internal safety and security review activities and the status of subsequent findings and corrective actions. The security part of this report must be made available for oversight agency review, consistent with § 659.23(e).

(g) The annual report must be accompanied by a formal letter of certification signed by the rail transit agency's chief executive, indicating that the rail transit agency is in compliance

with its system safety program plan and system security plan.

(h) If the rail transit agency determines that findings from its internal safety and security reviews indicate that the rail transit agency is not in compliance with its system safety program plan or system security plan, the chief executive must identify the activities the rail transit agency will take to achieve compliance.

(i) The oversight agency must formally review and approve the annual report.

§ 659.29 Oversight agency safety and security reviews.

At least every three (3) years, beginning with the initiation of rail transit agency passenger operations, the oversight agency must conduct an on-site review of the rail transit agency's implementation of its system safety program plan and system security plan. Alternatively, the on-site review may be conducted in an on-going manner over the three year timeframe. At the conclusion of the review cycle, the oversight agency must prepare and issue a report containing findings and recommendations resulting from that review, which, at a minimum, must include an analysis of the effectiveness of the system safety program plan and the security plan and a determination of whether either should be updated.

§ 659.31 Hazard management process.

(a) The oversight agency must require the rail transit agency to develop and document in its system safety program plan a process to identify and resolve hazards during its operation, including any hazards resulting from subsequent system extensions or modifications, operational changes, or other changes within the rail transit environment.

(b) The hazard management process must, at a minimum:

(1) Define the rail transit agency's approach to hazard management and the implementation of an integrated system-wide hazard resolution process;

(2) Specify the sources of, and the mechanisms to support, the on-going identification of hazards;

(3) Define the process by which identified hazards will be evaluated and prioritized for elimination or control;

(4) Identify the mechanism used to track through resolution the identified hazard(s);

(5) Define minimum thresholds for the notification and reporting of hazard(s) to oversight agencies; and

(6) Specify the process by which the rail transit agency will provide on-going reporting of hazard resolution activities to the oversight agency.

§ 659.33 Accident notification.

(a) The oversight agency must require the rail transit agency to notify the oversight agency within two (2) hours of any incident involving a rail transit vehicle or taking place on rail transit-controlled property where one or more of the following occurs:

(1) A fatality at the scene; or where an individual is confirmed dead within thirty (30) days of a rail transit-related incident;

(2) Injuries requiring immediate medical attention away from the scene for two or more individuals;

(3) Property damage to rail transit vehicles, non-rail transit vehicles, other rail transit property or facilities and non-transit property that equals or exceeds \$25,000;

(4) An evacuation due to life safety reasons;

(5) A collision at a grade crossing;

(6) A main-line derailment;

(7) A collision with an individual on a rail right of way; or

(8) A collision between a rail transit vehicle and a second rail transit vehicle, or a rail transit non-revenue vehicle.

(b) The oversight agency shall require rail transit agencies that share track with the general railroad system and are subject to the Federal Railroad Administration notification

requirements, to notify the oversight agency within two (2) hours of an incident for which the rail transit agency must also notify the Federal Railroad Administration.

(c) The oversight agency shall identify in its program standard the method of notification and the information to be provided by the rail transit agency

§ 659.35 Investigations.

(a) The oversight agency must investigate, or cause to be investigated, at a minimum, any incident involving a rail transit vehicle or taking place on rail transit-controlled property meeting the notification thresholds identified in § 659.33(a).

(b) The oversight agency must use its own investigation procedures or those that have been formally adopted from the rail transit agency and that have been submitted to FTA.

(c) In the event the oversight agency authorizes the rail transit agency to conduct investigations on its behalf, it must do so formally and require the rail transit agency to use investigation procedures that have been formally approved by the oversight agency.

(d) Each investigation must be documented in a final report that includes a description of investigation activities, identified causal and contributing factors, and a corrective action plan.

(e) A final investigation report must be formally adopted by the oversight agency for each accident investigation.

(1) If the oversight agency has conducted the investigation, it must formally transmit its final investigation report to the rail transit agency.

(2) If the oversight agency has authorized an entity other than itself (including the rail transit agency) to conduct the accident investigation on its behalf, the oversight agency must review and formally adopt the final investigation report.

(3) If the oversight agency does not concur with the findings of the rail transit agency investigation report, it must either:

(i) Conduct its own investigation according to paragraphs (b), (d) and (e)(1) of this section; or

(ii) Formally transmit its dissent to the findings of the accident investigation, report its dissent to the rail transit agency, and negotiate with the rail transit agency until a resolution on the findings is reached.

(f) The oversight agency shall have the authority to require periodic status reports that document investigation activities and findings in a time frame determined by the oversight agency.

§ 659.37 Corrective action plans.

(a) The oversight agency must, at a minimum, require the development of a corrective action plan for the following:

(1) Results from investigations, in which identified causal and contributing factors are determined by the rail transit agency or oversight agency as requiring corrective actions; and

(2) Findings from safety and security reviews performed by the oversight agency.

(b) Each corrective action plan should identify the action to be taken by the rail transit agency, an implementation schedule, and the individual or department responsible for the implementation.

(c) The corrective action plan must be reviewed and formally approved by the oversight agency.

(d) The oversight agency must establish a process to resolve disputes between itself and the rail transit agency resulting from the development or enforcement of a corrective action plan.

(e) The oversight agency must identify the process by which findings from an NTSB accident investigation will be evaluated to determine whether or not a corrective action plan should be developed by either the oversight agency or rail transit agency to address NTSB findings.

(f) The rail transit agency must provide the oversight agency:

(1) Verification that the corrective action(s) has been implemented as described in the corrective action plan, or that a proposed alternate action(s) has been implemented subject to oversight agency review and approval; and

(2) Periodic reports requested by the oversight agency, describing the status of each corrective action(s) not completely implemented, as described in the corrective action plan.

(g) The oversight agency must monitor and track the implementation of each approved corrective action plan.

§ 659.39 Oversight agency reporting to the Federal Transit Administration.

(a) *Initial submission.* Each designated oversight agency with a rail fixed guideway system that is in passenger operations as of April 29, 2005 or will begin passenger operations by May 1, 2006, must make its initial submission to FTA by May 1, 2006. In states with rail fixed guideway systems initiating passenger operations after May 1, 2006, the designated oversight agency must make its initial submission within the time frame specified by the state in its designation submission, but not later than at least sixty (60) days prior to initiation of passenger operations. Any time a state changes its designated oversight agency to carry out the requirements identified in this part, the new oversight agency must make a new

initial submission to FTA within thirty (30) days of the designation.

(b) An initial submission must include the following:

(1) Oversight agency program standard and referenced procedures; and

(2) Certification that the system safety program plan and the system security plan have been developed, reviewed, and approved.

(c) *Annual submission.* Before March 15 of each year, the oversight agency must submit the following to FTA:

(1) A publicly available annual report summarizing its oversight activities for the preceding twelve months, including a description of the causal factors of investigated accidents, status of corrective actions, updates and modifications to rail transit agency program documentation, and the level of effort used by the oversight agency to carry out its oversight activities.

(2) A report documenting and tracking findings from three-year safety review activities, and whether a three-year safety review has been completed since the last annual report was submitted.

(3) Program standard and supporting procedures that have changed during the preceding year.

(4) Certification that any changes or modifications to the rail transit agency system safety program plan or system

security plan have been reviewed and approved by the oversight agency.

(d) *Periodic submission.* FTA retains the authority to periodically request program information.

(e) *Electronic reporting.* All submissions to FTA required in this part must be submitted electronically using a reporting system specified by FTA.

§ 659.41 Conflict of interest.

The oversight agency shall prohibit a party or entity from providing services to both the oversight agency and rail transit agency when there is a conflict of interest, as defined by the state.

§ 659.43 Certification of compliance.

(a) Annually, the oversight agency must certify to the FTA that it has complied with the requirements of this part.

(b) The oversight agency must submit each certification electronically to FTA using a reporting system specified by FTA.

(c) The oversight agency must maintain a signed copy of each annual certification to FTA, subject to audit by FTA.

Issued on: April 4, 2005.

Jennifer L. Dorn,
Administrator.

[FR Doc. 05-8567 Filed 4-28-05; 8:45 am]

BILLING CODE 4910-57-P

This formula is also expressed in SI Metric terms, as follows:

$$d_H = AV_v t + \frac{BV_v^2}{a} + D + d_e \quad (6)$$

where:

- d_H = sight distance measured along the highway from the nearest rail to the driver of a vehicle, which allows the vehicle to be safely stopped without encroachment of the crossing area, feet
- A = constant = 0.278
- B = constant = 0.039
- V_v = velocity of the vehicle, kilometers per hour (km/hr.)
- t = perception-reaction time, seconds, assumed to be 2.5 seconds
- a = driver deceleration, assumed to be 3.4 meters per second²
- D = distance from the stop line or front of vehicle to the near rail, assumed to be 4.5 meters
- d_e = distance from the driver to the front of the vehicle, assumed to be 2.4 meters

The minimum safe sight distances, d_H , along the highway for selected vehicle speeds are shown in the bottom line of Tables 31 and 32. As noted, these distances were calculated for certain assumed conditions and should be increased for less favorable conditions.

The second sight distance utilizes a so-called “sight triangle” in the quadrants on the vehicle approach side of the track. This triangle is formed by:

- The distance (d_H) of the vehicle driver from the track.
- The distance (d_T) of the train from the crossing.
- The unobstructed sight line from the driver to the front of the train.

This sight triangle is depicted in Figure 8. The relationships between vehicle speed, maximum timetable train speed, distance along the highway (d_H), and distance along the railroad are set forth in the following formula:

$$d_T = \frac{V_T}{V_v} (A)V_v t + \frac{BV_v^2}{a} + 2D + L + W \quad (7)$$

Figure 8. Crossing Sight Distances

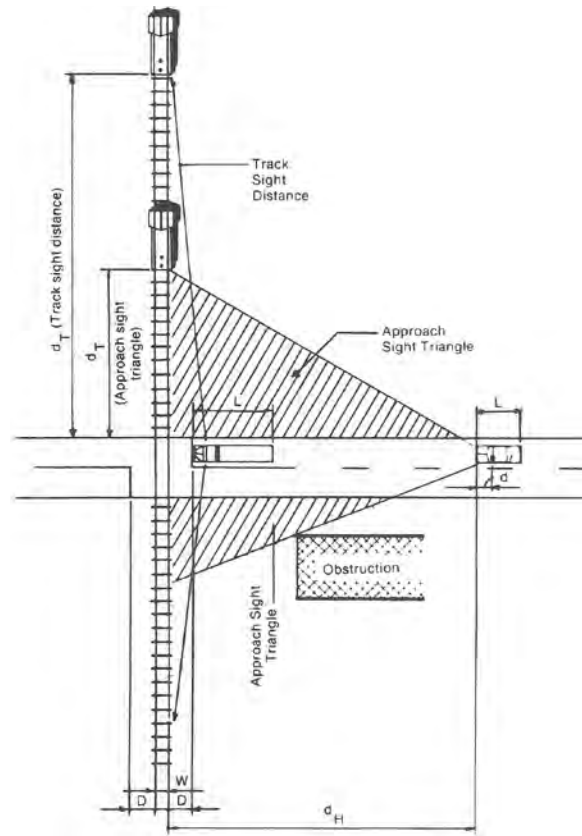

Source: Railroad-Highway Grade Crossing Handbook, Second Edition. Washington, DC: U.S. Department of Transportation, Federal Highway Administration, 1986.

where:

- d_T = sight distance along the railroad tracks to permit the vehicle to cross and be clear of the crossing upon arrival of the train
- A = constant = 1.47
- B = constant = 1.075
- V_v = velocity of the vehicle, mph
- t = perception-reaction time, seconds, assumed to be 2.5 seconds
- a = driver deceleration, assumed to be 11.2 feet per second²
- D = distance from the stop line or front of vehicle to the near rail, assumed to be 15 feet
- L = length of vehicle, assumed to be 65 feet
- W = distance between outer rails (for a single track, this value is 5 feet)

In SI Metric values, this formula becomes:

$$d_T = \frac{V_T}{V_v} (A)V_v t + \frac{BV_v^2}{a} + 2D + L + W \quad (8)$$

where:

- d_T = sight distance along the railroad tracks to permit the vehicle to cross and be clear of the crossing upon arrival of the train
- A = constant = 0.278
- B = constant = 0.039
- V_v = velocity of the vehicle, km/hr.
- t = perception-reaction time, seconds, assumed to be 2.5 seconds
- a = driver deceleration, assumed to be 3.4 meters per second²
- D = distance from the stop line or front of vehicle to the near rail, assumed to be 4.5 meters
- L = length of vehicle, assumed to be 20 meters
- W = distance between outer rails (for a single track, this value is 1.5 meters)

Distances d_h and d_T are shown in Tables 31 and 32 for several selected highway speeds and train speeds.

Clearing sight distance. In the case of a vehicle stopped at a crossing, the driver needs to see both ways along the track to determine whether a train is approaching and to estimate its speed. The driver needs to have a sight distance along the tracks that will permit sufficient time to accelerate and clear the crossing prior to the arrival of a train, even though the train might come into view as the vehicle is beginning its departure process.

Figure 9 illustrates the maneuver. These sight distances, for a range of train speeds, are given in the column for a vehicle speed of zero in Tables 31 and 32. These values are obtained from the following formula:

$$d_T = 1.47V_T \left(\frac{V_G}{a_1} + \frac{L + 2D + W - d}{V_G} + J \right) \quad (9)$$

where:

- V_G = maximum speed of vehicle in selected starting gear, assumed to be 8.8 feet per second
- a_1 = acceleration of vehicle in starting gear, assumed to be 1.47 feet per second per second
- J = sum of the perception time and the time required to activate the clutch or an automatic shift, assumed to be 2 seconds
- d_a = distance the vehicle travels while accelerating to maximum speed in first gear, or

$$d_a = \frac{V_G^2}{2a_1} \quad \text{or} \quad \frac{8.8^2}{(2)(1.47)} = 26.4 \text{ feet} \quad (10)$$

d_T , V_T , L, D, and W are defined as above.

Expressing the formula again in SI Metric terms:

$$d_T = 0.28V_T \left(\frac{V_G}{a_1} + \frac{L + 2D + W - d_a}{V_G} + J \right) \quad (11)$$

where:

- V_G = maximum speed of vehicle in selected starting gear, assumed to be 2.7 meters per second
- a_1 = acceleration of vehicle in starting gear, assumed to be 0.45 meter per second per second
- J = sum of the perception time and the time required to activate the clutch or an automatic shift, assumed to be 2 seconds
- d_a = distance the vehicle travels while accelerating to maximum speed in first gear, or

$$d_a = \frac{V_G^2}{2a_1}$$

$$\frac{2.7^2}{(2)(0.45)} = 8.1 \text{ meters}$$

d_T , V_T , L, D, and W are defined as above.⁶²

Figure 9. Sight Distance for a Vehicle Stopped at Crossing

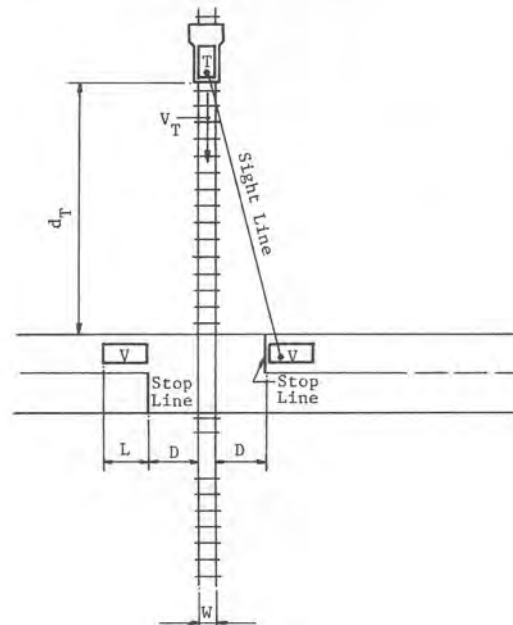

Source: Railroad-Highway Grade Crossing Handbook, Second Edition. Washington, DC: U.S. Department of Transportation, Federal Highway Administration, 1986.

Table 31. Sight Distances for Combinations of Highway Vehicle and Train Speeds, Metric

	Case B: Departure from stop	Case A: Moving vehicle												
	Vehicle speed (km/hr.)													
Train speed (km/hr.)	0	10	20	30	40	50	60	70	80	90	100	110	120	130
	Distance along railroad from crossing, d_r (feet)													
10	45	39	24	21	19	19	19	19	20	21	21	22	23	24
20	91	77	49	41	38	38	38	39	40	41	43	45	47	48
30	136	116	73	62	57	56	57	58	60	62	64	67	70	73
40	181	154	98	82	77	75	76	77	80	83	86	89	93	97
50	227	193	122	103	96	94	95	97	100	103	107	112	116	121
60	272	232	147	123	115	113	113	116	120	124	129	134	140	145
70	317	270	171	144	134	131	132	135	140	145	150	156	163	169
80	362	309	196	164	153	150	151	155	160	165	172	179	186	194
90	408	347	220	185	172	169	170	174	179	186	193	201	209	218
100	453	386	245	206	192	188	189	193	199	207	215	223	233	242
110	498	425	269	226	211	207	208	213	219	227	236	246	256	266
120	544	463	294	247	230	225	227	232	239	248	258	268	279	290
130	589	502	318	267	249	244	246	251	259	269	279	290	302	315
140	634	540	343	288	268	263	265	271	279	289	301	313	326	339
	Distance along highway from crossing, d_H (feet)													
		15	25	38	53	70	90	112	136	162	191	222	255	291

Source: From A Policy on Geometric Design of Highway and Streets, 2004, by the American Association of State Highway and Transportation Officials, Washington, DC. Used by permission.

Table 32. Sight Distances for Combinations of Highway Vehicle and Train Speeds, U.S. Customary

	Case B: Departure from stop	Case A: Moving vehicle							
	Vehicle speed (mph)								
Train speed (mph)	0	10	20	30	40	50	60	70	80
	Distance along railroad from crossing, d_r (feet)								
10	240	146	106	99	100	105	111	118	126
20	480	293	212	198	200	209	222	236	252
30	721	439	318	297	300	314	333	355	378
40	961	585	424	396	401	419	444	473	504
50	1201	732	530	494	501	524	555	591	630
60	1441	878	636	593	601	628	666	709	756
70	1681	1024	742	692	701	733	777	828	882
80	1921	1171	848	791	801	833	888	946	1008
90	2162	1317	954	890	901	943	999	1064	1134
	Distance along highway from crossing, d_H (feet)								
		69	135	220	324	447	589	751	931

Source: From A Policy on Geometric Design of Highway and Streets, 2004, by the American Association of State Highway and Transportation Officials, Washington, DC. Used by permission.

CHAPTER 8D. FLASHING-LIGHT SIGNALS, GATES, AND TRAFFIC CONTROL SIGNALS

Section 8D.01 Introduction

Support:

Active traffic control systems inform motorists, bicyclists, and pedestrians of the approach or presence of trains, locomotives, or other railroad equipment at highway-rail grade crossings.

A composite drawing (see Figure 8D-1) shows a post-mounted flashing-light signal (two light units mounted in a horizontal line), a flashing-light signal mounted on an overhead structure, and an automatic gate assembly.

Option:

Post-mounted and overhead-mounted flashing-light signals may be used separately or in combination with each other as determined by an engineering study. Also, flashing-light signals may be used without automatic gate assemblies, as determined by an engineering study.

Standard:

The meaning of flashing-light signals and gates shall be as stated in the “Uniform Vehicle Code” (see Sections 11-701 and 11-703 of the “UVC”), which is available from the National Committee on Uniform Traffic Laws and Ordinances (see Page i for the address).

Location and clearance dimensions for flashing-light signals and gates shall be as shown in Figure 8D-1.

When there is a curb, a horizontal clearance of at least 0.6 m (2 ft) shall be provided from the face of the vertical curb to the closest part of the signal or gate arm in its upright position. When a cantilevered-arm flashing-light signal is used, the vertical clearance shall be at least 5.2 m (17 ft) above the crown of the highway to the lowest point of the signal unit.

Where there is a shoulder, but no curb, a horizontal clearance of at least 0.6 m (2 ft) from the edge of a paved or surfaced shoulder shall be provided, with a clearance of at least 1.8 m (6 ft) from the edge of the traveled way.

Where there is no curb or shoulder, the minimum horizontal clearance shall be 1.8 m (6 ft) from the edge of the traveled way.

Guidance:

Equipment housings (controller cabinets) should have a lateral clearance of at least 9 m (30 ft) from the edge of the highway, and where railroad property and conditions allow, at least 7.6 m (25 ft) from the nearest rail.

If a pedestrian route is provided, sufficient clearance from supports, posts, and gate mechanisms should be maintained for pedestrian travel.

When determined by an engineering study, a lateral escape route to the right of the highway in advance of the highway-rail grade crossing traffic control devices should be kept free of guardrail or other ground obstructions. Where guardrail is not deemed necessary or appropriate, barriers should not be used for protecting signal supports.

The same lateral clearance and roadside safety features should apply to flashing-light signal and automatic gate locations on both the right and left sides of the roadway.

Option:

In industrial or other areas involving only low-speed highway traffic or where signals are vulnerable to damage by turning truck traffic, guardrail may be installed to provide protection for the signal assembly.

Section 8D.02 Flashing-Light Signals, Post-Mounted

Standard:

The flashing-light signal assembly (shown in Figure 8D-1) on the side of the highway shall include a standard Crossbuck (R15-1) sign, and where there is more than one track, a supplemental Number of Tracks (R15-2) sign, all of which indicate to motorists, bicyclists, and pedestrians the location of a highway-rail grade crossing.

Option:

Bells or other audible warning devices may be included in the assembly and may be operated in conjunction with the flashing lights to provide additional warning for pedestrians and bicyclists.

Standard:

When indicating the approach or presence of a train, the flashing-light signal shall display toward approaching highway traffic two red lights mounted in a horizontal line flashing alternately.

Figure 8D-1. Composite Drawing of Active Traffic Control Devices for Highway-Rail Grade Crossings Showing Clearances

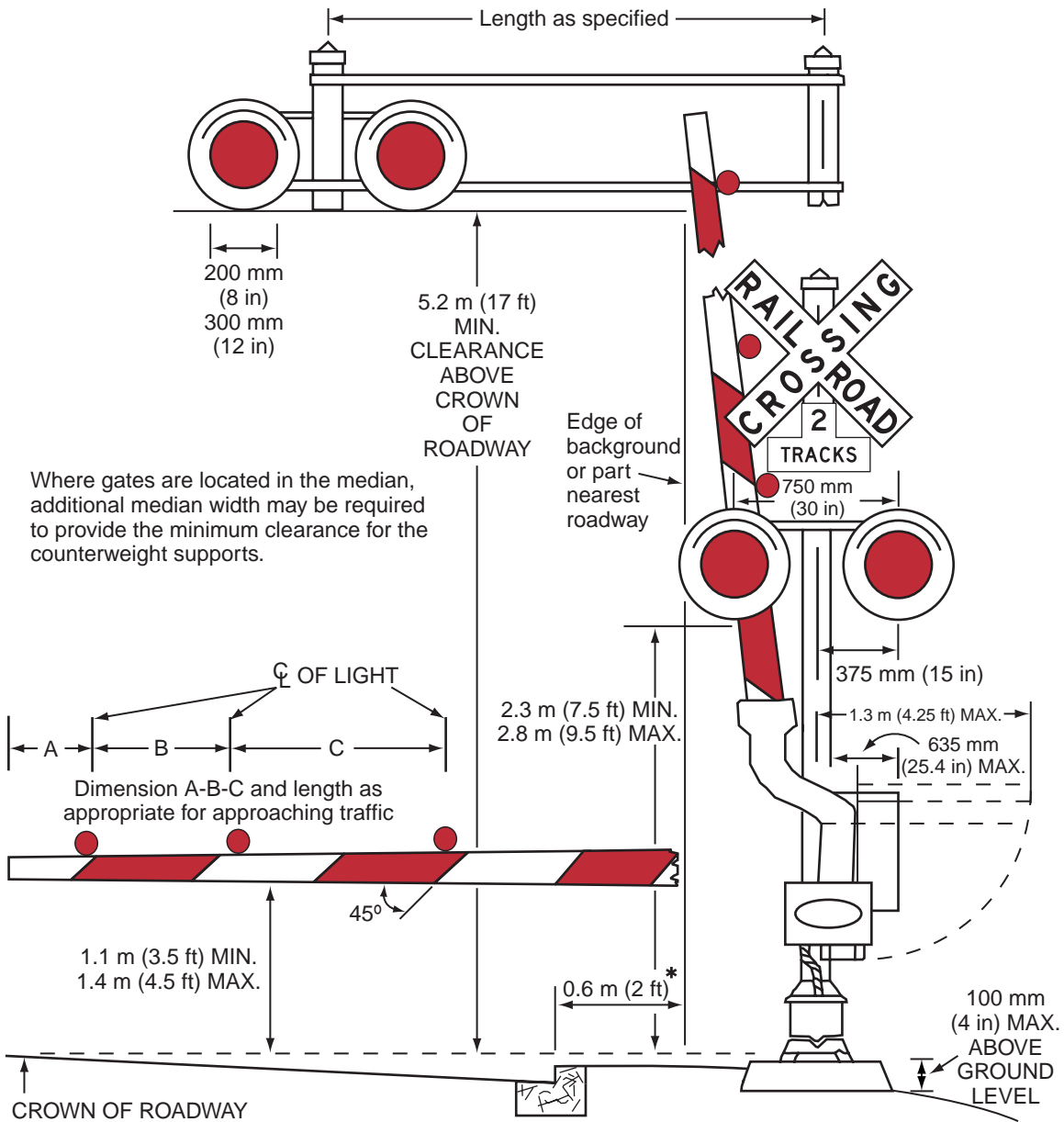

* For locating this reference line at other than curb section installation, see Section 8D.01.

Flashing-light signals shall be placed to the right of approaching highway traffic on all highway approaches to a highway-rail grade crossing. They shall be located laterally with respect to the highway in conformance with Figure 8D-1 except where such location would adversely affect signal visibility.

At highway-rail grade crossings with highway traffic in both directions, back-to-back pairs of lights shall be placed on each side of the tracks. On multi-lane one-way streets and divided highways, flashing light signals shall be placed on the approach side of the highway-rail grade crossing on both sides of the roadway or shall be placed above the highway.

Each red signal unit in the flashing-light signal shall flash alternately. The number of flashes per minute for each lamp shall be 35 minimum and 65 maximum. Each lamp shall be illuminated approximately the same length of time. Total time of illumination of each pair of lamps shall be the entire operating time. Flashing-light units shall use either 200 mm (8 in) or 300 mm (12 in) nominal diameter lenses.

Guidance:

In choosing between the 200 mm (8 in) or 300 mm (12 in) nominal diameter lenses for use in highway-rail grade crossing flashing-light signals, consideration should be given to the principles stated in Section 4D.15.

Standard:

Highway-rail grade crossing flashing-light signals shall operate at a low voltage using storage batteries either as a primary or stand-by source of electrical energy. Provision shall be made to provide a source of energy for charging batteries.

Option:

Additional pairs of flashing-light units may be mounted on the same supporting post and directed toward vehicular traffic approaching the highway-rail grade crossing from other than the principal highway route, such as where there are approaching routes on highways closely adjacent to and parallel to the railroad.

Section 8D.03 Flashing-Light Signals, Overhead Structures

Option:

Flashing-light signals may be installed on overhead structures or cantilevered supports as shown in Figure 8D-1 where needed for additional emphasis, or for better visibility to approaching traffic, particularly on multi-lane approaches or highways with profile restrictions.

If it is determined by an engineering study that one set of flashing lights on the cantilever arm is not sufficiently visible to road users, one or more additional sets of flashing lights may be mounted on the supporting post and/or on the cantilever arm.

Standard:

Breakaway or frangible bases shall not be used for overhead structures or cantilevered supports.

Section 8D.04 Automatic Gates

Support:

An automatic gate is a traffic control device used as an adjunct to flashing-light signals.

Standard:

The automatic gate (see Figure 8D-1) shall consist of a drive mechanism and a fully retroreflectorized red- and white-striped gate arm with lights. When in the down position, the gate arm shall extend across the approaching lanes of highway traffic.

In the normal sequence of operation, unless constant warning time or other advanced system requires otherwise, the flashing-light signals and the lights on the gate arm (in its normal upright position) shall be activated immediately upon detection of the approaching train. The gate arm shall start its downward motion not less than 3 seconds after the flashing-light signals start to operate, shall reach its horizontal position at least 5 seconds before the arrival of the train, and shall remain in the down position as long as the train occupies the highway-rail grade crossing.

When the train clears the highway-rail grade crossing, and if no other train is detected, the gate arm shall ascend to its upright position, following which the flashing lights and the lights on the gate arm shall cease operation.

Gate arms shall be fully retroreflectorized on both sides, have 45-degree diagonal stripes alternately red and white at 400 mm (16 in) intervals measured horizontally, and shall have at least three red lights as indicated in Figure 8D-1.

When activated, the gate arm light nearest the tip shall be illuminated continuously and the other lights shall flash alternately in unison with the flashing-light signals.

The entrance gate arm mechanism shall be designed to fail safe in the down position.

Guidance:

The gate arm should ascend to its upright position in not more than 12 seconds.

In its normal upright position, when no train is approaching or occupying the highway-rail grade crossing, the gate arm should be either vertical or nearly so (see Figure 8D-1).

In the design of individual installations, consideration should be given to timing the operation of the gate arm to accommodate large and/or slow-moving vehicles.

The gates should cover the approaching highway to block all motor vehicles from being driven around the gate without crossing the centerline.

Option:

Automatic gate installations may include median islands between opposing lanes on an approach to a highway-rail grade crossing.

Where gates are located in the median, additional median width may be required to provide the minimum clearance for the counterweight supports.

Section 8D.05 Four-Quadrant Gate Systems

Option:

Four-Quadrant Gate systems may be installed to improve safety at highway-rail grade crossings based on an engineering study when less restrictive measures, such as automatic gates and median islands, are not effective.

Standard:

A Four-Quadrant Gate system shall consist of a series of automatic gates used as an adjunct to flashing-light signals to control traffic on all lanes entering and exiting the highway-rail grade crossing.

The Four-Quadrant Gate system shall consist of a drive mechanism and fully retroreflectorized red- and white-striped gate arms with lights, and when in the down position the gate arms extend individually across the entrance and exit lanes of highway traffic as shown in Figure 8D-2. Standards contained in Sections 8D.01 through 8D.03 for flashing-light signals shall be followed for signal specifications, location, and clearance distances.

In the normal sequence of operation, unless constant warning time or other advanced system requires otherwise, the flashing-light signals and the lights on the gate arms (in their normal upright positions) shall be activated immediately upon detection of the approaching train. The gate arms for the entrance lanes of traffic shall start their downward motion not less than 3 seconds after the flashing-light signals start to operate and shall reach their horizontal position at least 5 seconds before the arrival of the train. Exit gate arm activation and downward motion shall be based on detection or timing requirements established by an engineering study of the individual site. The gate arms shall remain in the down position as long as the train occupies the highway-rail grade crossing.

When the train clears the highway-rail grade crossing, and if no other train is detected, the gate arms shall ascend to their upright positions, following which the flashing lights and the lights on the gate arms shall cease operation.

Gate arm design, colors, and lighting requirements shall be in accordance with the Standards contained in Section 8D.04.

Except as noted in the Option below, the exit gate arm mechanism shall be designed to fail-safe in the up position.

At locations where gate arms are offset a sufficient distance for vehicles to drive between the entrance and exit gate arms, median islands shall be installed in accordance with the needs established by an engineering study.

Guidance:

The gate arm should ascend to its upright position in not more than 12 seconds.

Four-Quadrant Gate systems should only be used in locations with constant-warning-time train detection.

The operating mode of the exit gates should be determined based upon an engineering study, with input from the affected railroad company.

If the Timed Exit Gate Operating Mode is used, the engineering study, with input from the affected railroad company, should also determine the Exit Gate Clearance Time (see Section 8A.01).

If the Dynamic Exit Gate Operating Mode is used, vehicle intrusion detection devices should be installed to control exit gate operation based on vehicle presence within the minimum track clearance distance.

Regardless of which exit gate operating mode is used, the Exit Gate Clearance Time should be considered when determining additional time requirements for the Minimum Warning Time.

If a Four-Quadrant Gate system is used at a location that is adjacent to an intersection that could cause vehicles to queue within the minimum track clearance distance, the Dynamic Exit Gate Operating Mode should be used unless an engineering study indicates otherwise.

If a Four-Quadrant Gate system is interconnected with a highway traffic signal, backup or standby power should be considered for the highway traffic signal. Also, circuitry should be installed to prevent the highway traffic signal from leaving the track clearance green interval until all of the gates are lowered.

At locations where sufficient space is available, exit gates should be set back from the track a distance that provides a safety zone long enough to accommodate at least one design vehicle between the exit gate and the nearest rail.

Four-Quadrant Gate systems should include remote health (status) monitoring capable of automatically notifying railroad signal maintenance personnel when anomalies have occurred within the system.

Option:

Exit gate arms may fail in the down position if the highway-rail grade crossing is equipped with remote health (status) monitoring.

Four-Quadrant Gate installations may include median islands between opposing lanes on an approach to a highway-rail grade crossing.

Guidance:

Where sufficient space is available, median islands should be at least 18 m (60 ft) in length.

Section 8D.06 Train Detection

Standard:

The devices employed in active traffic control systems shall be actuated by some form of train detection.

Train detection circuits, insofar as practical, shall be designed on the fail-safe principle.

Flashing-light signals shall operate for at least 20 seconds before the arrival of any train, except as noted in the Option below.

Option:

On tracks where all trains operate at less than 30 km/h (20 mph) and where flagging is performed by an employee on the ground, a shorter signal operating time for the flashing-light signals may be used.

Additional warning time may be provided when determined by an engineering study.

Guidance:

Where the speeds of different trains on a given track vary considerably under normal operation, special devices or circuits should be installed to provide reasonably uniform notice in advance of all train movements over the highway-rail grade crossing. Special control features should be used to eliminate the effects of station stops and switching operations within approach control circuits to prevent excessive activation of the traffic control devices while trains are stopped on or switching upon the approach track control circuits.

Section 8D.07 Traffic Control Signals at or Near Highway-Rail Grade Crossings

Option:

Traffic control signals may be used instead of flashing-light signals to control road users at industrial highway-rail grade crossings and other places where train movements are very slow, such as in switching operations.

Standard:

The appropriate provisions of Part 4 relating to traffic control signal design, installation, and operation shall be applicable where traffic control signals are used to control road users instead of flashing-light signals at highway-rail grade crossings.

Traffic control signals shall not be used instead of flashing-light signals to control road users at a mainline highway-rail grade crossing.

Guidance:

The highway agency with jurisdiction, the regulatory agency with statutory authority, if applicable, and the railroad company should jointly determine the preemption operation at highway-rail grade crossings adjacent to signalized highway intersections.

If a highway-rail grade crossing is equipped with a flashing-light signal system and is located within 60 m (200 ft) of an intersection or midblock location controlled by a traffic control signal, the traffic control signal should be provided with preemption in accordance with Section 4D.13.

Coordination with the flashing-light signal system, queue detection, or other alternatives should be considered for traffic control signals located farther than 60 m (200 ft) from the highway-rail grade crossing. Factors to be considered should include traffic volumes, vehicle mix, vehicle and train approach speeds, frequency of trains, and queue lengths.

Standard:

If preemption is provided, the normal sequence of traffic control signal indications shall be preempted upon the approach of trains to avoid entrapment of vehicles on the highway-rail grade crossing by conflicting aspects of the traffic control signals and the highway-rail grade crossing flashing-light signals.

This preemption feature shall have an electrical circuit of the closed-circuit principle, or a supervised communication circuit between the control circuits of the highway-rail grade crossing warning system and the traffic control signal controller. The traffic control signal controller preemptor shall be activated via the supervised communication circuit or the electrical circuit that is normally energized by the control circuits of the highway-rail grade crossing warning system. The approach of a train to a highway-rail grade crossing shall de-energize the electrical circuit or activate the supervised communication circuit, which in turn shall activate the traffic control signal controller preemptor. This shall establish and maintain the preemption condition during the time the highway-rail grade crossing warning system is activated, except that when crossing gates exist, the preemption condition shall be maintained until the crossing gates are energized to start their upward movement. When multiple or successive preemptions occur, train activation shall receive first priority.

Guidance:

If a highway-rail grade crossing is located within 15 m (50 ft) (or within 23 m (75 ft) for a highway that is regularly used by multi-unit vehicles) of an intersection controlled by a traffic control signal, the use of pre-signals to control traffic approaching the grade crossing should be considered.

Standard:

If used, the pre-signals shall display a red signal indication during the track clearance portion of a signal preemption sequence to prohibit additional vehicles from crossing the railroad track.

Guidance:

Consideration should be given to using visibility-limited signal faces (see Section 4A.02) at the intersection for the downstream signal faces that control the approach that is equipped with pre-signals.

Option:

The pre-signal phase sequencing may be timed with an offset from the signalized intersection such that the railroad track area and the area between the railroad track and the downstream signalized intersection is generally kept clear of stopped vehicles.

Standard:

If a pre-signal is installed at an interconnected highway-rail grade crossing near a signalized intersection, a STOP HERE ON RED (R10-6) sign shall be installed near the pre-signal or at the stop line if used. If there is a nearby signalized intersection with insufficient clear storage distance for a design vehicle, or the highway-rail grade crossing does not have gates, a NO TURN ON RED (R10-11) sign shall be installed for the approach that crosses the railroad track.

Option:

At locations where a highway-rail grade crossing is located more than 15 m (50 ft) (or more than 23 m (75 ft) for a highway regularly used by multi-unit vehicles) from an intersection controlled by a traffic control signal, a pre-signal may be used if an engineering study determines a need.

If highway traffic signals must be located within close proximity to the flashing-light signal system, the highway traffic signals may be mounted on the same overhead structure as the flashing-light signals.

Support:

Section 4D.13 describes additional considerations regarding preemption of traffic control signals at or near highway-rail grade crossings.

Flashing Gate Placement 2003 MUTCD Section 8D.01

Criteria 1:

“When there is a curb, a horizontal clearance of at least 0.6m (2 ft) shall be provided from the face of the vertical curb to the closest part of the signal gate arm in its upright position. When a cantilevered-arm flashing-light signal is used, the vertical clearance shall be at least 5.2 m (17 ft) above the crown of the highway to the lowest point of the signal unit.”

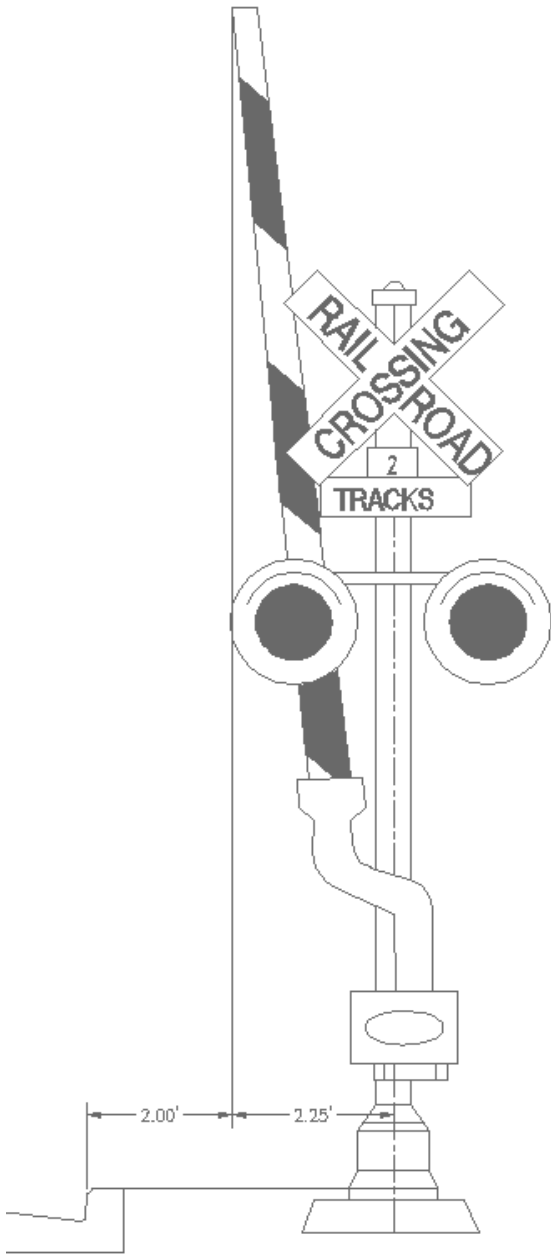

Figure 8D.01 Criteria 1

Criteria 2:

“Where there is a shoulder, but no curb, a horizontal clearance of at least 0.6 m (2 ft) from the edge of a paved or surfaced shoulder shall be provided, with a clearance of at least 1.8 m (6 ft) from the edge of the traveled way.”

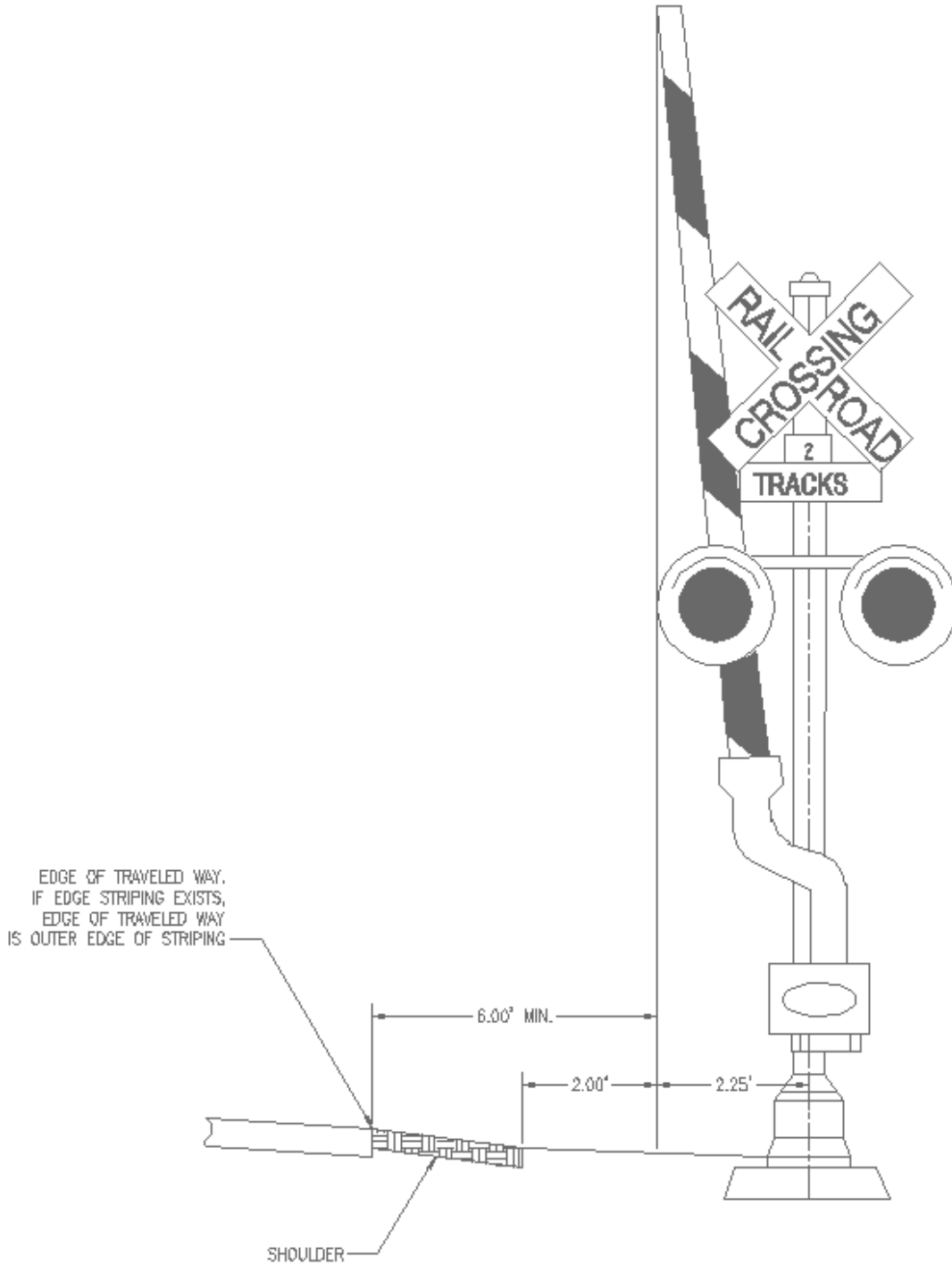

Figure 8D.01 Criteria 2

Criteria 3:

“Where there is no curb or shoulder, the minimum horizontal clearance shall be 1.8 m (6 ft) from the edge of the traveled way.”

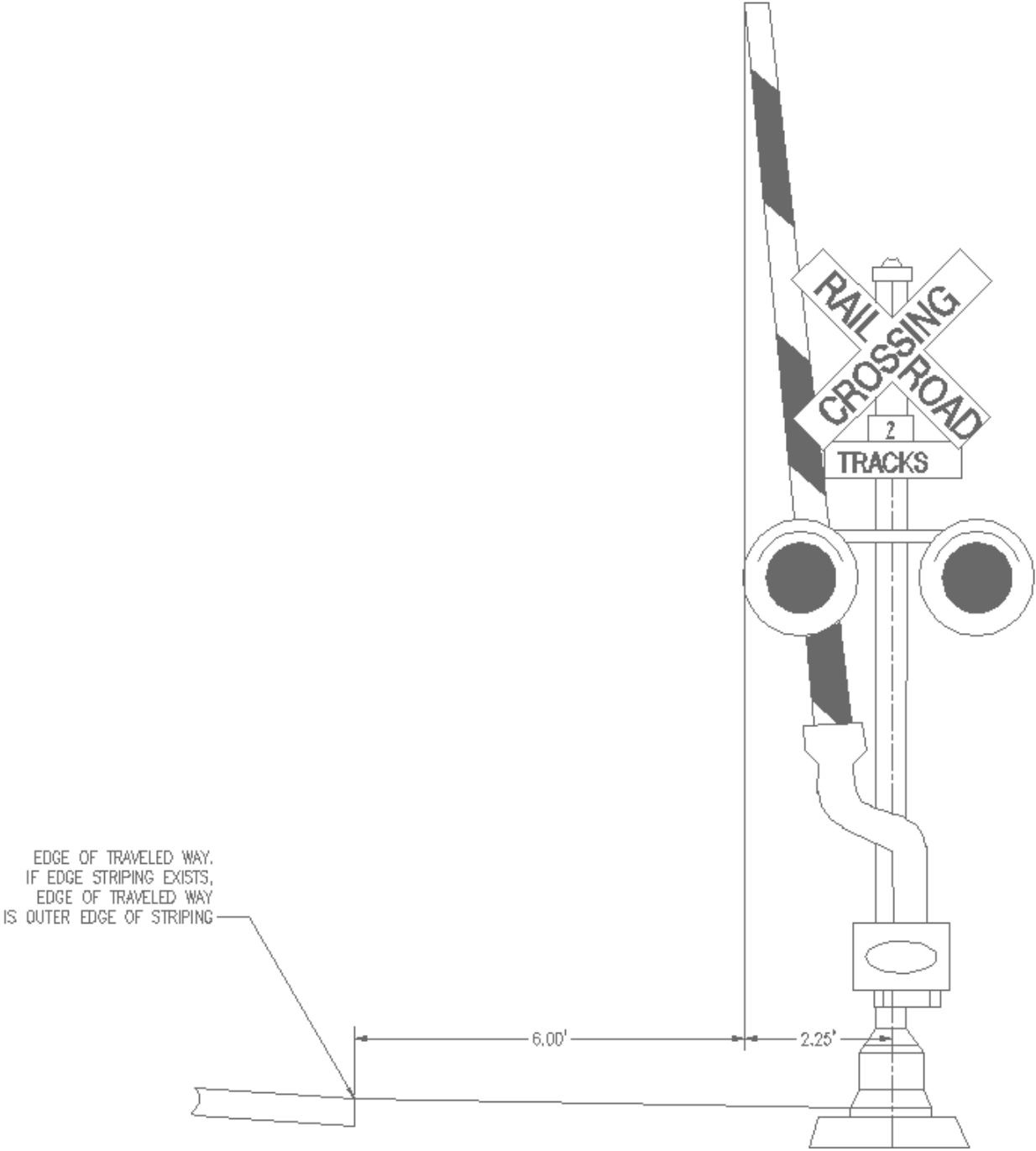

Figure 8D.01 Criteria 3

Crossbuck Signs MUTCD Sect. 8B.02

Criteria 1:

“Crossbuck signs should be located with respect to the highway pavement or shoulder in accordance with the criteria in Chapter 2A and Figures 2A-1 and 2A-2, and should be located with respect to the nearest track in accordance with Figure 8D-2.”

“The lateral clearance for the nearest edge of the Crossbuck sign should be 1.8 m (6 ft) from the edge of the shoulder, or 3.7 m (12 ft) from the edge of the traveled way in rural areas, and 0.6 m (2 ft) from the face of the curb in urban areas.”

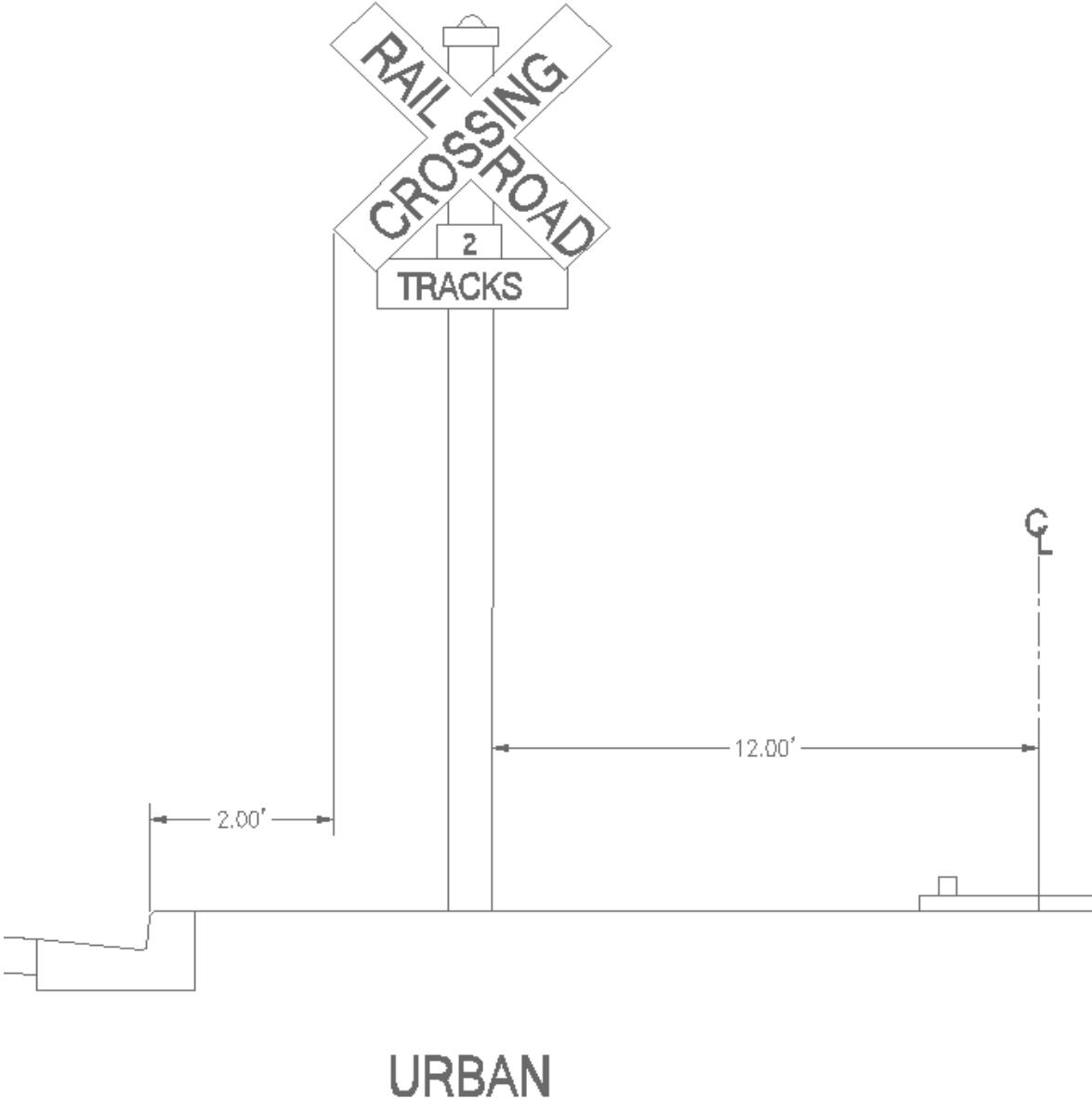

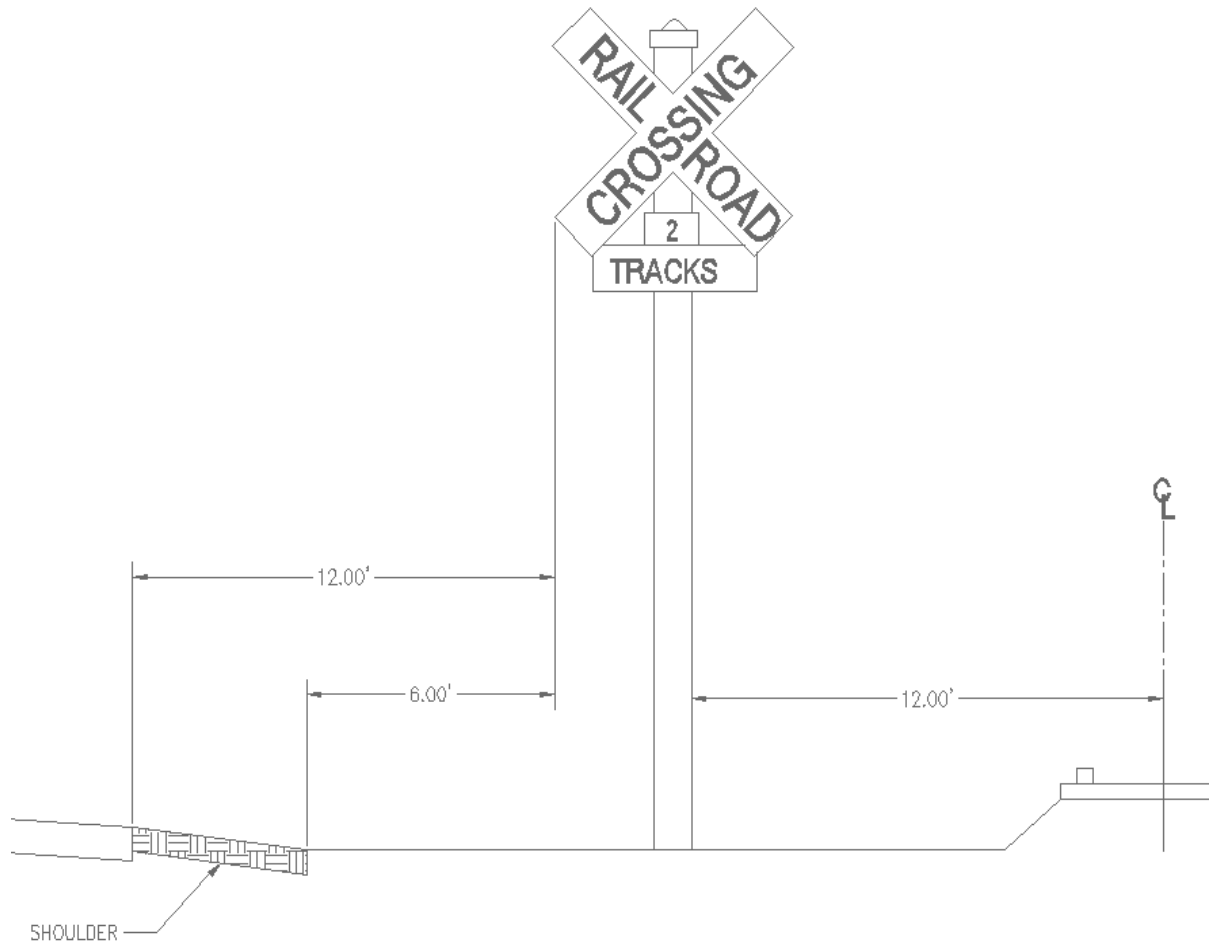

RURAL

APPENDIX SECTION 2
STATE DOCUMENTS

10-7-26. Streets and alleys used by railway companies.

(1) As used in this section and in Sections 10-7-27, 10-7-29, 10-7-30, 10-7-31, 10-7-32, and 10-7-33, the terms "railway company" or "street railway company" means any company which owns or operates railway tracks on, along or across a street or alley in any city or town.

(2) Nothing contained in this section or in the sections referred to in Subsection (1) shall be construed to exempt any railway company from keeping every portion of every street and alley used by it and upon or across which tracks shall be constructed at or near the grade of such streets in good and safe condition for public travel, but it shall keep the same planked, paved, macadamized or otherwise in such condition for public travel as the governing body of the city or town may from time to time direct, keeping the plank, pavement or other surface of the street or alley level with the top of the rails of the track. The portions of the streets or alleys to be so kept and maintained by all such railway companies shall include all the space between their different rails and tracks and also a space outside of the outer rail of each outside track of at least two feet in width, and the tracks herein referred to shall include not only the main tracks but also all sidetracks, crossings and turnouts constructed for the use of such railways.

10-7-27. Street railway companies to restore streets.

Every street railway company shall at its own expense restore the pavement, including the foundation thereof, of every street disturbed by it in the construction, reconstruction, removal or repair of its tracks, to the same condition as before the disturbance thereof, to the satisfaction of the governing body having charge of such street. The obligation imposed hereby shall, in cities other than cities of the first class, be in lieu and substitution of any and all other obligations of any such company to pave, repave or repair any street, or to pay any part of the cost thereof, and may be enforced in the same manner as similar obligations are or may be enforced under the laws of this state. Nothing herein contained shall be considered to relieve any such company from the repayment of any money which has heretofore been advanced or expended by any city for any paving heretofore done under or by virtue of a specific contract or agreement made and entered into between the board of commissioners or the city council of any city and such company providing for the repayment thereof, but the obligation for such repayment shall be and remain enforceable as if this section had not been passed.

10-7-29. Railway companies to repave streets.

All railway companies shall be required to pave or repave at their own cost all the space between their different rails and tracks and also a space two feet wide outside of the outer rails of the outside tracks in any city or town, including all sidetracks, crossings and turnouts used by such companies. Where two or more companies occupy the same street or alley with separate tracks each company shall be responsible for its proportion of the surface of the street or alley occupied by all the parallel tracks as herein required. Such paving or repaving by such railway companies shall be done at the same time and shall be of the same material and character as the paving or repaving of the streets or alleys upon which the track or tracks are located, unless other material is specially ordered by the municipality. Such railway companies shall be required to keep that portion of the street which they are herein required to pave or repave in good and proper repair, using for that purpose the same material as the street upon which the track or tracks are laid at the point of repair or such other material as the governing body of the city may require and order; and as streets are hereafter paved or repaved street railway companies shall be required to lay in the best approved manner a rail to be approved by the governing body of the city. The tracks of all railway companies when located upon the streets or avenues of a city or town shall be kept in repair and safe in all respects for the use of the traveling public, and such companies shall be liable for all damages resulting by reason of neglect to keep such tracks in repair, or for obstructing the streets. For injuries to persons or property arising from the failure of any such company to keep its tracks in proper repair and free from obstructions such company shall be liable and the city or town shall be exempt from liability. The word "railway companies" as used in this section shall be taken to mean and include any persons, companies, corporations or associations owning or operating any street or other railway in any city or town.

41-6a-1205. Railroad grade crossings -- Certain vehicles must stop -- Exceptions -- Rules.

(1) An operator of a commercial motor vehicle, as defined under Section 53-3-102, shall upon approaching a railroad grade crossing:

- (a) unless Subsection (2) applies, slow down and check that the tracks are clear of an approaching train;
- (b) stop within 50 feet, but not closer than 15 feet, from the nearest rail of the railroad track before reaching the crossing if the tracks are not clear;
- (c) obey all traffic control devices or the directions of a peace officer, or other crossing official at the crossing; and
- (d) before proceeding over a railroad grade crossing:
 - (i) ensure that the vehicle has sufficient space to drive completely through a railroad grade crossing without stopping; and
 - (ii) ensure that the vehicle has sufficient undercarriage clearance to safely and completely pass through the crossing.

(2) (a) Except as provided in Subsection (3), the operator of a vehicle described in 49 CFR 392.10 shall stop within 50 feet, but not closer than 15 feet, from the nearest rail of the railroad track before crossing, at grade, any track of a railroad.

(b) While stopped, the operator shall look in both directions along the track for any sign of an approaching train and look and listen for signals indicating the approach of any train.

(c) The operator may proceed across the railroad track only when the movement may be made with reasonable safety.

(d) After stopping as required and upon safely proceeding, the operator shall only cross the railroad track in a gear that ensures no necessity for manually changing gears while traversing the crossing.

(e) The operator may not manually shift gears while crossing the railroad track.

(3) This section does not apply at a:

- (a) railroad grade crossing where traffic is controlled by a peace officer or other crossing official;
- (b) railroad grade crossing where traffic is regulated by a traffic-control signal;
- (c) railroad grade crossing where a traffic-control device gives notice that the stopping requirements of this section are not applicable; or
- (d) other railroad grade crossings excluded under 49 CFR 392.10.

54-4-14. Safety regulation.

The commission shall have power, by general or special orders, rules or regulations, or otherwise, to require every public utility to construct, maintain and operate its line, plant, system, equipment, apparatus, tracks and premises in such manner as to promote and safeguard the health and safety of its employees, passengers, customers and the public, and to this end to prescribe, among other things, the installation, use, maintenance and operation of appropriate safety or other devices or appliances including interlocking and other protective devices at grade crossings or junctions, and block or other system of signaling, and to establish uniform or other standards of construction and equipment, and to require the performance of any other acts which the health or safety of its employees, passengers, customers or the public may demand, provided, however, that the department of transportation shall have jurisdiction over those safety functions transferred to it by the Department of Transportation Act.

54-4-15. Establishment and regulation of grade crossings.

(1) No track of any railroad shall be constructed across a public road, highway or street at grade, nor shall the track of any railroad corporation be constructed across the track of any other railroad or street railroad corporation at grade, nor shall the track of a street railroad corporation be constructed across the track of a railroad corporation at grade, without the permission of the Department of Transportation having first been secured; provided, that this subsection shall not apply to the replacement of lawfully existing tracks. The department shall have the right to refuse its permission or to grant it upon such terms and conditions as it may prescribe.

(2) The department shall have the power to determine and prescribe the manner, including the particular point of crossing, and the terms of installation, operation, maintenance, use and protection of each crossing of one railroad by another railroad or street railroad, and of a street railroad by a railroad and of each crossing of a public road or highway by a railroad or street railroad, and of a street by a railroad or vice versa, and to alter or abolish any such crossing, to restrict the use of such crossings to certain types of traffic in the interest of public safety and is vested with power and it shall be its duty to designate the railroad crossings to be traversed by school buses and motor vehicles carrying passengers for hire, and to require, where in its judgment it would be practicable, a separation of grades at any such crossing heretofore or hereafter established, and to prescribe the terms upon which such separation shall be made and the proportions in which the expense of the alteration or abolition of such crossings or the separation of such grades shall be divided between the railroad or street railroad corporations affected, or between such corporations and the state, county, municipality or other public authority in interest.

(3) Whenever the department shall find that public convenience and necessity demand the establishment, creation or construction of a crossing of a street or highway over, under or upon the tracks or lines of any public utility, the department may by order, decision, rule or decree require the establishment, construction or creation of such crossing, and such crossing shall thereupon become a public highway and crossing.

(4) (a) The commission retains exclusive jurisdiction for the resolution of any dispute upon petition by any person aggrieved by any action of the department pursuant to this section, except as provided under Subsection (4)(b).

(b) If a petition is filed by a person or entity engaged in a subject activity, as defined in Section 19-3-318, the commission's decision under Subsection (4)(a) regarding resolution of a dispute requires the concurrence of the governor and the Legislature in order to take effect.

63G-3-101. Title.

This chapter is known as the "Utah Administrative Rulemaking Act."

63G-3-102. Definitions.

As used in this chapter:

- (1) "Administrative record" means information an agency relies upon when making a rule under this chapter including:
 - (a) the proposed rule, change in the proposed rule, and the rule analysis form;
 - (b) the public comment received and recorded by the agency during the public comment period;
 - (c) the agency's response to the public comment;
 - (d) the agency's analysis of the public comment; and
 - (e) the agency's report of its decision-making process.
- (2) "Agency" means each state board, authority, commission, institution, department, division, officer, or other state government entity other than the Legislature, its committees, the political subdivisions of the state, or the courts, which is authorized or required by law to make rules, adjudicate, grant or withhold licenses, grant or withhold relief from legal obligations, or perform other similar actions or duties delegated by law.
- (3) "Bulletin" means the Utah State Bulletin.
- (4) "Catchline" means a short summary of each section, part, rule, or title of the code that follows the section, part, rule, or title reference placed before the text of the rule and serves the same function as boldface in legislation as described in Section 68-3-13.
- (5) "Code" means the body of all effective rules as compiled and organized by the division and entitled "Utah Administrative Code."
- (6) "Director" means the director of the Division of Administrative Rules.
- (7) "Division" means the Division of Administrative Rules.
- (8) "Effective" means operative and enforceable.
- (9) (a) "File" means to submit a document to the division as prescribed by the division.
(b) "Filing date" means the day and time the document is recorded as received by the division.
- (10) "Interested person" means any person affected by or interested in a proposed rule, amendment to an existing rule, or a nonsubstantive change made under Section 63G-3-402.
- (11) "Order" means an agency action that determines the legal rights, duties, privileges, immunities, or other interests of one or more specific persons, but not a class of persons.
- (12) "Person" means any individual, partnership, corporation, association, governmental entity, or public or private organization of any character other than an agency.
- (13) "Publication" or "publish" means making a rule available to the public by including the rule or a summary of the rule in the bulletin.
- (14) "Publication date" means the inscribed date of the bulletin.
- (15) "Register" may include an electronic database.
- (16) (a) "Rule" means an agency's written statement that:
 - (i) is explicitly or implicitly required by state or federal statute or other applicable law;
 - (ii) implements or interprets a state or federal legal mandate; and
 - (iii) applies to a class of persons or another agency.

- (b) "Rule" includes the amendment or repeal of an existing rule.
- (c) "Rule" does not mean:
 - (i) orders;
 - (ii) an agency's written statement that applies only to internal management and that does not restrict the legal rights of a public class of persons or another agency;
 - (iii) the governor's executive orders or proclamations;
 - (iv) opinions issued by the attorney general's office;
 - (v) declaratory rulings issued by the agency according to Section 63G-4-503 except as required by Section 63G-3-201;
 - (vi) rulings by an agency in adjudicative proceedings, except as required by Subsection 63G-3-201(6); or
 - (vii) an agency written statement that is in violation of any state or federal law.
- (17) "Rule analysis" means the format prescribed by the division to summarize and analyze rules.
- (18) "Small business" means a business employing fewer than 50 persons.
- (19) "Substantive change" means a change in a rule that affects the application or results of agency actions.

63G-3-201. When rulemaking is required.

- (1) Each agency shall:
 - (a) maintain a current version of its rules; and
 - (b) make it available to the public for inspection during its regular business hours.
- (2) In addition to other rulemaking required by law, each agency shall make rules when agency action:
 - (a) authorizes, requires, or prohibits an action;
 - (b) provides or prohibits a material benefit;
 - (c) applies to a class of persons or another agency; and
 - (d) is explicitly or implicitly authorized by statute.
- (3) Rulemaking is also required when an agency issues a written interpretation of a state or federal legal mandate.
- (4) Rulemaking is not required when:
 - (a) agency action applies only to internal agency management, inmates or residents of a state correctional, diagnostic, or detention facility, persons under state legal custody, patients admitted to a state hospital, members of the state retirement system, or students enrolled in a state education institution;
 - (b) a standardized agency manual applies only to internal fiscal or administrative details of governmental entities supervised under statute;
 - (c) an agency issues policy or other statements that are advisory, informative, or descriptive, and do not conform to the requirements of Subsections (2) and (3); or
 - (d) an agency makes nonsubstantive changes in a rule, except that the agency shall file all nonsubstantive changes in a rule with the division.
- (5) (a) A rule shall enumerate any penalty authorized by statute that may result from its violation, subject to Subsections (5)(b) and (c).
- (b) A violation of a rule may not be subject to the criminal penalty of a class C

misdemeanor or greater offense, except as provided under Subsection (5)(c).

(c) A violation of a rule may be subject to a class C or greater criminal penalty under Subsection (5)(a) when:

- (i) authorized by a specific state statute;
- (ii) a state law and programs under that law are established in order for the state to obtain or maintain primacy over a federal program; or
- (iii) state civil or criminal penalties established by state statute regarding the program are equivalent to or less than corresponding federal civil or criminal penalties.

(6) Each agency shall enact rules incorporating the principles of law not already in its rules that are established by final adjudicative decisions within 120 days after the decision is announced in its cases.

(7) (a) Each agency may enact a rule that incorporates by reference:

(i) all or any part of another code, rule, or regulation that has been adopted by a federal agency, an agency or political subdivision of this state, an agency of another state, or by a nationally recognized organization or association;

(ii) state agency implementation plans mandated by the federal government for participation in the federal program;

(iii) lists, tables, illustrations, or similar materials that are subject to frequent change, fully described in the rule, and are available for public inspection; or

(iv) lists, tables, illustrations, or similar materials that the director determines are too expensive to reproduce in the administrative code.

(b) Rules incorporating materials by reference shall:

(i) be enacted according to the procedures outlined in this chapter;

(ii) state that the referenced material is incorporated by reference;

(iii) state the date, issue, or version of the material being incorporated; and

(iv) define specifically what material is incorporated by reference and identify any agency deviations from it.

(c) The agency shall identify any substantive changes in the material incorporated by reference by following the rulemaking procedures of this chapter.

(d) The agency shall maintain a complete and current copy of the referenced material available for public review at the agency and at the division.

(8) (a) This chapter is not intended to inhibit the exercise of agency discretion within the limits prescribed by statute or agency rule.

(b) An agency may enact a rule creating a justified exception to a rule.

(9) An agency may obtain assistance from the attorney general to ensure that its rules meet legal and constitutional requirements.

63G-3-202. Rules having the effect of law.

(1) An agency's written statement is a rule if it conforms to the definition of a rule under Section 63G-3-102, but the written statement is not enforceable unless it is made as a rule in accordance with the requirements of this chapter.

(2) An agency's written statement that is made as a rule in accordance with the requirements of this chapter is enforceable and has the effect of law.

63G-3-301. Rulemaking procedure.

(1) An agency authorized to make rules is also authorized to amend or repeal those rules.

(2) Except as provided in Sections 63G-3-303 and 63G-3-304, when making, amending, or repealing a rule agencies shall comply with:

- (a) the requirements of this section;
- (b) consistent procedures required by other statutes;
- (c) applicable federal mandates; and
- (d) rules made by the division to implement this chapter.

(3) Subject to the requirements of this chapter, each agency shall develop and use flexible approaches in drafting rules that meet the needs of the agency and that involve persons affected by the agency's rules.

(4) (a) Each agency shall file its proposed rule and rule analysis with the division.

(b) Rule amendments shall be marked with new language underlined and deleted language struck out.

(c) (i) The division shall publish the information required under Subsection (8) on the rule analysis and the text of the proposed rule in the next issue of the bulletin.

(ii) For rule amendments, only the section or subsection of the rule being amended need be printed.

(iii) If the director determines that the rule is too long to publish, the director shall publish the rule analysis and shall publish the rule by reference to a copy on file with the division.

(5) Prior to filing a rule with the division, the department head shall consider and comment on the fiscal impact a rule may have on businesses.

(6) If the agency reasonably expects that a proposed rule will have a measurable negative fiscal impact on small businesses, the agency shall consider, as allowed by federal law, each of the following methods of reducing the impact of the rule on small businesses:

(a) establishing less stringent compliance or reporting requirements for small businesses;

(b) establishing less stringent schedules or deadlines for compliance or reporting requirements for small businesses;

(c) consolidating or simplifying compliance or reporting requirements for small businesses;

(d) establishing performance standards for small businesses to replace design or operational standards required in the proposed rule; and

(e) exempting small businesses from all or any part of the requirements contained in the proposed rule.

(7) If during the public comment period an agency receives comment that the proposed rule will cost small business more than one day's annual average gross receipts, and the agency had not previously performed the analysis in Subsection (6), the agency shall perform the analysis described in Subsection (6).

(8) The rule analysis shall contain:

(a) a summary of the rule or change;

(b) the purpose of the rule or reason for the change;

(c) the statutory authority or federal requirement for the rule;

(d) the anticipated cost or savings to:

- (i) the state budget;
- (ii) local governments;
- (iii) small businesses; and
- (iv) persons other than small businesses, businesses, or local governmental entities;
- (e) the compliance cost for affected persons;
- (f) how interested persons may review the full text of the rule;
- (g) how interested persons may present their views on the rule;
- (h) the time and place of any scheduled public hearing;
- (i) the name and telephone number of an agency employee who may be contacted about the rule;
- (j) the name of the agency head or designee who authorized the rule;
- (k) the date on which the rule may become effective following the public comment period; and
- (l) comments by the department head on the fiscal impact the rule may have on businesses.

(9) (a) For a rule being repealed and reenacted, the rule analysis shall contain a summary that generally includes the following:

- (i) a summary of substantive provisions in the repealed rule which are eliminated from the enacted rule; and

- (ii) a summary of new substantive provisions appearing only in the enacted rule.

(b) The summary required under this Subsection (9) is to aid in review and may not be used to contest any rule on the ground of noncompliance with the procedural requirements of this chapter.

(10) A copy of the rule analysis shall be mailed to all persons who have made timely request of the agency for advance notice of its rulemaking proceedings and to any other person who, by statutory or federal mandate or in the judgment of the agency, should also receive notice.

(11) (a) Following the publication date, the agency shall allow at least 30 days for public comment on the rule.

(b) The agency shall review and evaluate all public comments submitted in writing within the time period under Subsection (11)(a) or presented at public hearings conducted by the agency within the time period under Subsection (11)(a).

(12) (a) Except as provided in Sections 63G-3-303 and 63G-3-304, a proposed rule becomes effective on any date specified by the agency that is no fewer than seven calendar days after the close of the public comment period under Subsection (11), nor more than 120 days after the publication date.

(b) The agency shall provide notice of the rule's effective date to the division in the form required by the division.

(c) The notice of effective date may not provide for an effective date prior to the date it is received by the division.

(d) The division shall publish notice of the effective date of the rule in the next issue of the bulletin.

(e) A proposed rule lapses if a notice of effective date or a change to a proposed rule is not filed with the division within 120 days of publication.

(13) (a) As used in this Subsection (13), "initiate rulemaking proceedings" means the filing, for the purposes of publication in accordance with Subsection (4), of an agency's proposed

rule that is required by state statute.

(b) A state agency shall initiate rulemaking proceedings no later than 180 days after the effective date of the statutory provision that specifically requires the rulemaking, except under Subsection (13)(c).

(c) When a statute is enacted that requires agency rulemaking and the affected agency already has rules in place that meet the statutory requirement, the agency shall submit the rules to the Administrative Rules Review Committee for review within 60 days after the statute requiring the rulemaking takes effect.

(d) If a state agency does not initiate rulemaking proceedings in accordance with the time requirements in Subsection (13)(b), the state agency shall appear before the legislative Administrative Rules Review Committee and provide the reasons for the delay.

63G-3-302. Public hearings.

(1) Each agency may hold a public hearing on a proposed rule, amendment to a rule, or repeal of a rule during the public comment period.

(2) Each agency shall hold a public hearing on a proposed rule, amendment to a rule, or repeal of a rule if:

(a) a public hearing is required by state or federal mandate;

(b) (i) another state agency, 10 interested persons, or an interested association having not fewer than 10 members request a public hearing; and

(ii) the agency receives the request in writing not more than 15 days after the publication date of the proposed rule.

(3) The agency shall hold the hearing:

(a) before the rule becomes effective; and

(b) no less than seven days nor more than 30 days after receipt of the request for hearing.

63G-3-303. Changes in rules.

(1) (a) To change a proposed rule already published in the bulletin, an agency shall file with the division:

(i) the text of the changed rule; and

(ii) a rule analysis containing a description of the change and the information required by Section 63G-3-301.

(b) A change to a proposed rule may not be filed more than 120 days after publication of the rule being changed.

(c) The division shall publish the rule analysis for the changed rule in the bulletin.

(d) The changed proposed rule and its associated proposed rule will become effective on a date specified by the agency, not less than 30 days or more than 120 days after publication of the last change in proposed rule.

(e) A changed proposed rule and its associated proposed rule lapse if a notice of effective date or another change to a proposed rule is not filed with the division within 120 days of publication of the last change in proposed rule.

(2) If the rule change is nonsubstantive:

(a) the agency need not comply with the requirements of Subsection (1); and

- (b) the agency shall notify the division of the change in writing.
- (3) If the rule is effective, the agency shall amend the rule according to the procedures specified in Section 63G-3-301.

63G-3-304. Emergency rulemaking procedure.

(1) All agencies shall comply with the rulemaking procedures of Section 63G-3-301 unless an agency finds that these procedures would:

- (a) cause an imminent peril to the public health, safety, or welfare;
- (b) cause an imminent budget reduction because of budget restraints or federal requirements; or

(c) place the agency in violation of federal or state law.

(2) (a) When finding that its rule is excepted from regular rulemaking procedures by this section, the agency shall file with the division:

- (i) the text of the rule; and
- (ii) a rule analysis that includes the specific reasons and justifications for its findings.

(b) The division shall publish the rule in the bulletin as provided in Subsection 63G-3-301(4).

(c) The agency shall notify interested persons as provided in Subsection 63G-3-301(10).

(d) The rule becomes effective for a period not exceeding 120 days on the date of filing or any later date designated in the rule.

(3) If the agency intends the rule to be effective beyond 120 days, the agency shall also comply with the procedures of Section 63G-3-301.

63G-3-305. Agency review of rules -- Schedule of filings -- Limited exemption for certain rules.

(1) Each agency shall review each of its rules within five years of the rule's original effective date or within five years of the filing of the last five-year review, whichever is later. Rules effective prior to 1992 need not be reviewed until 1997.

(2) An agency may consider any substantial review of a rule to be a five-year review. If the agency chooses to consider a review a five-year review, it shall follow the procedures outlined in Subsection (3).

(3) At the conclusion of its review, the agency shall file a notice of review on or before the anniversary date indicating its intent to continue, amend, or repeal the rule.

(a) If the agency continues the rule, it shall file a statement which includes:

- (i) a concise explanation of the particular statutory provisions under which the rule is enacted and how these provisions authorize or require the rule;
- (ii) a summary of written comments received during and since the last five-year review of the rule from interested persons supporting or opposing the rule; and
- (iii) a reasoned justification for continuation of the rule, including reasons why the agency disagrees with comments in opposition to the rule, if any.

(b) If the agency repeals the rule, it shall comply with Section 63G-3-301.

(c) If the agency amends and continues the rule, it shall comply with the requirements of Section 63G-3-301 and file the statement required in Subsection (3)(a).

(4) (a) The division shall publish the notice and statement in the bulletin.

(b) The division may schedule the publication of agency notices and statements, provided that no notice and statement shall be published more than one year after the review deadline established under Subsection (1).

(5) The division shall notify an agency of rules due for review at least 180 days prior to the anniversary date.

(6) If an agency finds that it will not meet the deadline established in Subsection (1):

(a) the agency may file an extension prior to the anniversary date with the division indicating the reason for the extension; and

(b) the division shall publish notice of the extension in the next issue of the bulletin.

(7) An extension permits the agency to file a notice no more than 120 days after the anniversary date.

(8) If an agency fails to file a notice of review or extension on or before the date specified in the notice mandated in Subsection (5), the division shall:

(a) publish a notice in the next issue of the bulletin that the rule has expired and is no longer enforceable;

(b) remove the rule from the code; and

(c) notify the agency that the rule has expired.

(9) After a rule expires, an agency must comply with the requirements of Section 63G-3-301 to reenact the rule.

(10) (a) Rules issued under the following provisions related to the Department of Workforce Services or Labor Commission that are in effect on July 1, 1997, are not subject to the requirements of this section until July 1, 1998:

(i) Title 34, Labor in General;

(ii) Title 34A, Utah Labor Code;

(iii) Title 35A, Utah Workforce Services Code;

(iv) Title 40, Chapter 2, Coal Mines; and

(v) Title 57, Chapter 21, Utah Fair Housing Act.

(b) Any rule described in Subsection (10)(a) that would have expired on or after July 1, 1997 but before July 1, 1998, expires July 1, 1998, unless for that rule the Department of Workforce Services or Labor Commission files:

(i) the notice of review, described in Subsection (3); or

(ii) an extension described in Subsection (6).

63G-3-401. Division of Administrative Rules created -- Appointment of director.

(1) There is created within the Department of Administrative Services the Division of Administrative Rules, to be administered by a director.

(2) The director of administrative rules shall be appointed by the executive director with the approval of the governor.

63G-3-402. Division of Administrative Rules -- Duties generally.

(1) The Division of Administrative Rules shall:

(a) establish all filing, publication, and hearing procedures necessary to make rules under this chapter;

(b) record in a register the receipt of all agency rules, rule analysis forms, and notices of

effective dates;

(c) make the register, copies of all proposed rules, and rulemaking documents available for public inspection;

(d) publish all proposed rules, rule analyses, notices of effective dates, and review notices in the bulletin at least monthly, except that the division may publish the complete text of any proposed rule that the director determines is too long to print or too expensive to publish by reference to the text maintained by the division;

(e) compile, format, number, and index all effective rules in an administrative code, and periodically publish that code and supplements or revisions to it;

(f) publish a digest of all rules and notices contained in the most recent bulletin;

(g) publish at least annually an index of all changes to the administrative code and the effective date of each change;

(h) print, or contract to print, all rulemaking publications the division determines necessary to implement this chapter;

(i) distribute without charge the bulletin and administrative code to state-designated repositories, the Administrative Rules Review Committee, the Office of Legislative Research and General Counsel, and the two houses of the Legislature;

(j) distribute without charge the digest and index to state legislators, agencies, political subdivisions on request, and the Office of Legislative Research and General Counsel;

(k) distribute, at prices covering publication costs, all paper rulemaking publications to all other requesting persons and agencies;

(l) provide agencies assistance in rulemaking;

(m) if the Department of Administrative Services operates the division as an internal service fund agency in accordance with Section 63A-1-109.5, submit to the Rate Committee established in Section 63A-1-114:

(i) the proposed rate and fee schedule as required by Section 63A-1-114; and

(ii) other information or analysis requested by the Rate Committee; and

(n) administer this chapter and require state agencies to comply with filing, publication, and hearing procedures.

(2) The division may after notifying the agency make nonsubstantive changes to rules filed with the division or published in the bulletin or code by:

(a) implementing a uniform system of formatting, punctuation, capitalization, organization, numbering, and wording;

(b) correcting obvious errors and inconsistencies in punctuation, capitalization, numbering, referencing, and wording;

(c) changing a catchline to more accurately reflect the substance of each section, part, rule, or title;

(d) updating or correcting annotations associated with a section, part, rule, or title; and

(e) merging or determining priority of any amendment, enactment, or repeal to the same rule or section made effective by an agency.

(3) In addition, the division may make the following nonsubstantive changes with the concurrence of the agency:

(a) eliminate duplication within rules;

(b) eliminate obsolete and redundant words; and

(c) correcting defective or inconsistent section and paragraph structure in arrangement of the subject matter of rules.

(4) For nonsubstantive changes made in accordance with Subsection (2) or (3) after publication of the rule in the bulletin, the division shall publish a list of nonsubstantive changes in the bulletin. For each nonsubstantive change, the list shall include:

- (a) the affected code citation;
- (b) a brief description of the change; and
- (c) the date the change was made.

(5) All funds appropriated or collected for publishing the division's publications shall be nonlapsing.

63G-3-403. Repeal and reenactment of Utah Administrative Code.

(1) When the director determines that the Utah Administrative Code requires extensive revision and reorganization, the division may repeal the code and reenact a new code according to the requirements of this section.

(2) The division may:

- (a) reorganize, reformat, and renumber the code;
- (b) require each agency to review its rules and make any organizational or substantive changes according to the requirements of Section 63G-3-303; and
- (c) require each agency to prepare a brief summary of all substantive changes made by the agency.

(3) The division may make nonsubstantive changes in the code by:

- (a) adopting a uniform system of punctuation, capitalization, numbering, and wording;
- (b) eliminating duplication;
- (c) correcting defective or inconsistent section and paragraph structure in arrangement of the subject matter of rules;
- (d) eliminating all obsolete or redundant words;
- (e) correcting obvious errors and inconsistencies in punctuation, capitalization, numbering, referencing, and wording;
- (f) changing a catchline to more accurately reflect the substance of each section, part, rule, or title;
- (g) updating or correcting annotations associated with a section, part, rule, or title; and
- (h) merging or determining priority of any amendment, enactment, or repeal to the same rule or section made effective by an agency.

(4) (a) To inform the public about the proposed code reenactment, the division shall publish in the bulletin:

- (i) notice of the code reenactment;
- (ii) the date, time, and place of a public hearing where members of the public may comment on the proposed reenactment of the code;
- (iii) locations where the proposed reenactment of the code may be reviewed; and
- (iv) agency summaries of substantive changes in the reenacted code.

(b) To inform the public about substantive changes in agency rules contained in the proposed reenactment, each agency shall:

- (i) make the text of their reenacted rules available:
 - (A) for public review during regular business hours; and
 - (B) in an electronic version; and
- (ii) comply with the requirements of Subsection 63G-3-301(10).

(5) The division shall hold a public hearing on the proposed code reenactment no fewer than 30 days nor more than 45 days after the publication required by Subsection (4)(a).

(6) The division shall distribute complete text of the proposed code reenactment without charge to:

- (a) state-designated repositories in Utah;
- (b) the Administrative Rules Review Committee; and
- (c) the Office of Legislative Research and General Counsel.

(7) The former code is repealed and the reenacted code is effective at noon on a date designated by the division that is not fewer than 45 days nor more than 90 days after the publication date required by this section.

(8) Repeal and reenactment of the code meets the requirements of Section 63G-3-305 for a review of all agency rules.

63G-3-501. Administrative Rules Review Committee.

(1) (a) There is created an Administrative Rules Review Committee of 10 permanent members and four ex officio members.

(b) (i) The committee's permanent members shall be composed of five members of the Senate, appointed by the president of the Senate, and five members of the House, appointed by the speaker of the House, with no more than three senators and three representatives from the same political party.

(ii) The permanent members shall convene at least once each month as a committee to review new agency rules, amendments to existing agency rules, and repeals of existing agency rules. Meetings may be suspended at the discretion of the committee chairs.

(iii) Members shall serve for two-year terms or until their successors are appointed.

(iv) A vacancy exists whenever a committee member ceases to be a member of the Legislature, or when a member resigns from the committee. Vacancies shall be filled by the appointing authority, and the replacement shall serve out the unexpired term.

(c) When the committee reviews existing rules, the committee's permanent members shall invite the Senate and House chairmen of the standing committee and the Senate and House chairmen of the appropriation subcommittee that have jurisdiction over the agency whose existing rules are being reviewed to participate as nonvoting, ex officio members with the committee.

(d) Three representatives and three senators from the permanent members are a quorum for the transaction of business at any meeting.

(2) Each agency rule as defined in Section 63G-3-102 shall be submitted to the committee at the same time public notice is given under Section 63G-3-301.

(3) (a) The committee shall exercise continuous oversight of the process of rulemaking.

(b) The committee shall examine rules submitted by each agency to determine:

- (i) whether or not they are authorized by statute;
- (ii) whether or not they comply with legislative intent;
- (iii) their impact on the economy and the government operations of the state and local political subdivisions; and
- (iv) their impact on affected persons.

(c) To carry out these duties, the committee may examine any other issues that it considers necessary. The committee may also notify and refer rules to the chairmen of the

interim committee which has jurisdiction over a particular agency when the committee determines that an issue involved in an agency's rules may be more appropriately addressed by that committee.

(d) In reviewing the rules, the committee shall follow generally accepted principles of statutory construction.

(4) The committee may request that the Office of the Legislative Fiscal Analyst prepare a fiscal note on any rule.

(5) In order to accomplish its oversight functions, the committee has all the powers granted to legislative interim committees as set forth in Section 36-12-11.

(6) (a) The committee may prepare written findings of its review of each rule and may include any recommendations, including legislative action.

(b) The committee shall provide to the agency that enacted the rule:

(i) its findings, if any; and

(ii) a request that the agency notify the committee of any changes it makes in the rule.

(c) The committee shall provide its findings to any member of the Legislature and to any person affected by the rule who requests the findings.

(d) The committee shall provide its findings to the presiding officers of both the House and the Senate, Senate and House chairs of the standing committee, and the Senate and House chairs of the Appropriation Subcommittee that have jurisdiction over the agency whose rules are the subject of the findings.

(7) (a) The committee may submit a report on its review of state agency rules to each member of the Legislature at each regular session.

(b) The report shall include:

(i) the findings and recommendations made by the committee under Subsection (6);

(ii) any action taken by an agency in response to committee recommendations; and

(iii) any recommendations by the committee for legislation.

63G-3-502. Legislative reauthorization of agency rules -- Extension of rules by governor.

(1) All grants of rulemaking power from the Legislature to a state agency in any statute are made subject to the provisions of this section.

(2) (a) Except as provided in Subsection (2)(b), every agency rule that is in effect on February 28 of any calendar year expires on May 1 of that year unless it has been reauthorized by the Legislature.

(b) Notwithstanding the provisions of Subsection (2)(a), an agency's rules do not expire if:

(i) the rule is explicitly mandated by a federal law or regulation; or

(ii) a provision of Utah's constitution vests the agency with specific constitutional authority to regulate.

(3) (a) The Administrative Rules Review Committee shall have omnibus legislation prepared for consideration by the Legislature during its annual general session.

(b) The omnibus legislation shall be substantially in the following form: "All rules of Utah state agencies are reauthorized except for the following:".

(c) Before sending the legislation to the governor for the governor's action, the Administrative Rules Review Committee may send a letter to the governor and to the agency

explaining specifically why the committee believes any rule should not be reauthorized.

(d) For the purpose of this section, the entire rule, a single section, or any complete paragraph of a rule may be excepted for reauthorization in the omnibus legislation considered by the Legislature.

(4) The Legislature's reauthorization of a rule by legislation does not constitute legislative approval of the rule, nor is it admissible in any proceeding as evidence of legislative intent.

(5) (a) If an agency believes that a rule that has not been reauthorized by the Legislature or that will be allowed to expire should continue in full force and effect and is a rule within their authorized rulemaking power, the agency may seek the governor's declaration extending the rule beyond the expiration date.

(b) In seeking the extension, the agency shall submit a petition to the governor that affirmatively states:

(i) that the rule is necessary; and

(ii) a citation to the source of its authority to make the rule.

(c) (i) If the governor finds that the necessity does exist, and that the agency has the authority to make the rule, the governor may declare the rule to be extended by publishing that declaration in the Administrative Rules Bulletin on or before April 15 of that year.

(ii) The declaration shall set forth the rule to be extended, the reasons the extension is necessary, and a citation to the source of the agency's authority to make the rule.

(d) If the omnibus bill required by Subsection (3) fails to pass both houses of the Legislature or is found to have a technical legal defect preventing reauthorization of administrative rules intended to be reauthorized by the Legislature, the governor may declare all rules to be extended by publishing a single declaration in the Administrative Rules Bulletin on or before June 15 without meeting requirements of Subsections (5)(b) and (c).

63G-3-601. Interested parties -- Petition for agency action.

(1) As used in this section, "initiate rulemaking proceedings" means the filing, for the purposes of publication in accordance with Subsection 63G-3-301(4), of an agency's proposed rule to implement a petition for the making, amendment, or repeal of a rule as provided in this section.

(2) An interested person may petition an agency to request the making, amendment, or repeal of a rule.

(3) The division shall prescribe by rule the form for petitions and the procedure for their submission, consideration, and disposition.

(4) A statement shall accompany the proposed rule, or proposed amendment or repeal of a rule, demonstrating that the proposed action is within the jurisdiction of the agency and appropriate to the powers of the agency.

(5) Within 60 days after submission of a petition, the agency shall either deny the petition in writing, stating its reasons for the denial, or initiate rulemaking proceedings.

(6) (a) If the petition is submitted to a board that has been granted rulemaking authority by the Legislature, the board shall, within 45 days of the submission of the petition, place the petition on its agenda for review.

(b) Within 80 days of the submission of the petition, the board shall either:

(i) deny the petition in writing stating its reasons for denial; or

(ii) initiate rulemaking proceedings.

(7) If the agency or board has not provided the petitioner written notice that the agency has denied the petition or initiated rulemaking proceedings within the time limitations specified in Subsection (5) or (6) respectively, the petitioner may seek a writ of mandamus in state district court.

63G-3-602. Judicial challenge to administrative rules.

(1) (a) Any person aggrieved by a rule may obtain judicial review of the rule by filing a complaint with the county clerk in the district court where the person resides or in the district court in Salt Lake County.

(b) Any person aggrieved by an agency's failure to comply with Section 63G-3-201 may obtain judicial review of the agency's failure to comply by filing a complaint with the clerk of the district court where the person resides or in the district court in Salt Lake County.

(2) (a) Except as provided in Subsection (2)(b), a person seeking judicial review under this section shall exhaust that person's administrative remedies by complying with the requirements of Section 63G-3-601 before filing the complaint.

(b) When seeking judicial review of a rule, the person need not exhaust that person's administrative remedies if:

(i) less than six months has passed since the date that the rule became effective and the person had submitted verbal or written comments on the rule to the agency during the public comment period;

(ii) a statute granting rulemaking authority expressly exempts rules made under authority of that statute from compliance with Section 63G-3-601; or

(iii) compliance with Section 63G-3-601 would cause the person irreparable harm.

(3) (a) In addition to the information required by the Utah Rules of Civil Procedure, a complaint filed under this section shall contain:

(i) the name and mailing address of the plaintiff;

(ii) the name and mailing address of the defendant agency;

(iii) the name and mailing address of any other party joined in the action as a defendant;

(iv) the text of the rule or proposed rule, if any;

(v) an allegation that the person filing the complaint has either exhausted the administrative remedies by complying with Section 63G-3-601 or met the requirements for waiver of exhaustion of administrative remedies established by Subsection (2)(b);

(vi) the relief sought; and

(vii) factual and legal allegations supporting the relief sought.

(b) (i) The plaintiff shall serve a summons and a copy of the complaint as required by the Utah Rules of Civil Procedure.

(ii) The defendants shall file a responsive pleading as required by the Utah Rules of Civil Procedures.

(iii) The agency shall file the administrative record of the rule, if any, with its responsive pleading.

(4) The district court may grant relief to the petitioner by:

(a) declaring the rule invalid, if the court finds that:

(i) the rule violates constitutional or statutory law or the agency does not have legal authority to make the rule;

- (ii) the rule is not supported by substantial evidence when viewed in light of the whole administrative record; or
 - (iii) the agency did not follow proper rulemaking procedure;
 - (b) declaring the rule nonapplicable to the petitioner;
 - (c) remanding the matter to the agency for compliance with proper rulemaking procedures or further fact-finding;
 - (d) ordering the agency to comply with Section 63G-3-201;
 - (e) issuing a judicial stay or injunction to enjoin the agency from illegal action or action that would cause irreparable harm to the petitioner; or
 - (f) any combination of Subsections (4)(a) through (e).
- (5) If the plaintiff meets the requirements of Subsection (2)(b), the district court may review and act on a complaint under this section whether or not the plaintiff has requested the agency review under Section 63G-3-601.

63G-3-603. Time for contesting a rule -- Statute of limitations.

(1) A proceeding to contest any rule on the ground of noncompliance with the procedural requirements of this chapter shall commence within two years of the effective date of the rule.

(2) A proceeding to contest any rule on the ground of not being supported by substantial evidence when viewed in light of the whole administrative record shall commence within four years of the effective date of the challenged action.

(3) A proceeding to contest any rule on the basis that a change to the rule made under Subsection 63G-3-402(2) or (3) substantively changed the rule shall be commenced within two years of the date the change was made.

63G-3-701. Utah Administrative Code as official compilation of rules -- Judicial notice.

The code shall be received by all the judges, public officers, commissions, and departments of the state government as evidence of the administrative law of the state of Utah and as an authorized compilation of the administrative law of Utah. All courts shall take judicial notice of the code and its provisions.

63G-3-702. Utah Administrative Code -- Organization -- Official compilation.

- (1) The Utah Administrative Code shall be divided into three parts:
 - (a) titles, whose number shall begin with "R";
 - (b) rules; and
 - (c) sections.
- (2) All sections contained in the code are referenced by a three-part number indicating its location in the code.
- (3) The division shall maintain the official compilation of the code and is the state-designated repository for administrative rules. If a dispute arises in which there is more than one version of a rule, the latest effective version on file with the division is considered the correct, current version.

72-1-201. Creation of Department of Transportation -- Functions, powers, duties, rights, and responsibilities.

There is created the Department of Transportation which shall:

- (1) have the general responsibility for planning, research, design, construction, maintenance, security, and safety of state transportation systems;
- (2) provide administration for state transportation systems and programs;
- (3) implement the transportation policies of the state;
- (4) plan, develop, construct, and maintain state transportation systems that are safe, reliable, environmentally sensitive, and serve the needs of the traveling public, commerce, and industry;
- (5) establish standards and procedures regarding the technical details of administration of the state transportation systems as established by statute and administrative rule;
- (6) advise the governor and the Legislature about state transportation systems needs;
- (7) coordinate with utility companies for the reasonable, efficient, and cost-effective installation, maintenance, operation, relocation, and upgrade of utilities within state highway rights-of-way;
- (8) in accordance with Title 63G, Chapter 3, Utah Administrative Rulemaking Act, make policy and rules for the administration of the department, state transportation systems, and programs; and
- (9) annually report to an appropriate legislative committee as designated by the Legislative Management Committee the transfers that need to be made between all transportation-related funds to maintain the state highway construction program as prioritized by the commission.

R930. Transportation, Preconstruction.

R930-5. Establishment and Regulation of At-Grade Railroad Crossings.

R930-5-1. Purpose and Authority.

(1) The Utah Department of Transportation (the "Department") oversees all Public Highway-Rail Grade Crossings ("Crossings") in the state of Utah. Railroads have jurisdiction over and are responsible for the safety of private crossings. The Department's goals are to improve the safety for all users of a Crossing and provide for the efficient operation of trains and vehicles and pedestrians access through those Crossings. As part of this effort, the Department promotes the elimination of Crossings and at regular intervals, the Department:

(a) Reviews all existing Crossings in the state for safety deficiencies;

(b) Evaluates and approves the location of a new Crossing;

(c) Prescribes the type of improvements at a Crossing;

(d) Defines maintenance responsibility for a Crossing; and

(e) Determines funding apportionments for all Section 130 Crossing Projects.

(2) This rule describes procedures for evaluating and selecting a Crossing for improvement as well as for evaluating and selecting the type of improvements at a Crossing. Such improvements include, but are not limited to:

(a) The evaluation and selection of the type of Passive and Active Warning Devices;

(b) The process for evaluating and determining whether a Crossing should be grade separated; and

(c) The process for evaluating Quiet Zones as outlined in 49 CFR 222.

(3) This Rule outlines the responsibilities of the various parties with respect to the design, maintenance and funding for Crossing improvements.

(4) This Rule is authorized by Section 54-4-15 "Establishment and Regulation of Grade Crossings," Section 54-4-14, Section 72-1-201, Section 41-6a-1205 and Title 63G, Chapter 3 "Utah Administrative Rulemaking Act."

R930-5-2. Incorporation by Reference.

The following federal law, state law, federal agency manuals, association standards and UDOT technical requirements are incorporated by reference:

(1) 23 CFR 148 "Highway Safety Improvement Program" (2005);

(2) 23 CFR 646 "Railroads" (2009);

(3) 23 CFR 655 "Traffic Operations" (2009) "Manual of Uniform Traffic Control Devices (MUTCD)" (2003, with revisions 1 and 2 incorporated, dated 2007);

(4) 23 CFR 924 "Highway Safety Improvement Program" (2009);

(5) 49 CFR 209 "Accidents and Incidents" (2009);

(6) 49 CFR 212 "State Safety Participation Regulations" (2009);

(7) 49 CFR 222 "Use of Locomotive Horns at Public Highway-Rail Grade Crossing" (2009)

(8) 49 CFR 659 "Rail Fixed Guideway Systems; State Safety

Oversight" (2009);

(9) "A Policy on Geometric Design of Highway and Streets", American Association of State Highway and Transportation Officials (AASHTO) (2004);

(10) "Railroad-Highway Grade Crossing Handbook", Federal Highway Administration (FHWA) (August 2007);

(11) "Preemption of traffic signals near Railroad Crossings", Institute of Traffic Engineers (ITE) (2004);

(12) "Manual for Railway Engineering", Chapter 28, Clearances, American Railway Engineering and Maintenance-of-Way Association (AREMA), 2007; and

(13) "Standard Drawing ST-7 Pavement Marking and Signs at Railroad Crossings", Utah Department of Transportation (UDOT) (2008).

R930-5-3. Definitions.

(1) "Active Warning Device" means traffic control devices activated by the approach or presence of a train, such as flashing light signals, automatic gates and similar devices, as well as manually operated devices and Crossing watchmen, all of which display to motorists positive warning of the approach or presence of a train.

(2) "Company" means any local district or utility company.

(3) "Diagnostic Team" means an appointed group of knowledgeable representatives of the parties of interest in a Crossing or group of Crossings.

(4) "FHWA" means the Federal Highway Administration, an agency within the United States Department of Transportation.

(5) "FRA" means the Federal Railroad Administration, an agency within the United States Department of Transportation.

(6) "FTA" means the Federal Transit Administration, an agency within the United States Department of Transportation.

(7) "Highway" means any public road, street, alley, lane, court, place, viaduct, tunnel, bridge, or structure laid out or erected for public use, or dedicated or abandoned to the public, or made public in an action for the partition of real property, including the area within the right-of-way.

(8) "Highway-Rail Grade Crossing" ("Crossing") means the general area where a Highway and a Railroad cross at the same level within which are included the Railroad, Highway, and roadside facilities for public traffic traversing the area.

(9) "Highway Authority" means the Department or local governmental entity that owns or has jurisdiction over a Highway.

(10) "MUTCD" means the Manual of Uniform Traffic Control Devices as adopted in Section 41-6a-301.

(11) "Neutral Quadrant" means the quadrant that minimizes sight distance conflicts with immediate on-coming auto traffic. Generally, the neutral quadrant is on the far side of the tracks from the direction of vehicular travel.

(12) "Passive Warning Device" means those types of traffic control devices, including signs, markings and other devices located at or in advance of a Crossing to indicate the presence of a Crossing but which do not change aspect upon the approach or presence of a train.

(13) "Preliminary Engineering" means the work necessary to produce construction plans, specifications, and estimates to the degree of completeness required for undertaking construction, including locating, surveying, designing, and related work.

(14) "PSC" means the Public Service Commission of the State of Utah.

(15) "Quiet Zone" means a section of a rail line at least one half mile in length that contains one or more consecutive public Crossings at which locomotive horns are not routinely sounded, see 49 CFR 222.

(16) "Railroad" means all rail carriers, whether publicly or privately owned, and common carriers, including line haul freight and passenger railroads, public transit districts, switching and terminal railroads, passenger carrying railroads such as rapid transit, and commuter and street railroads.

(17) "Section 130 Crossing Project" means a project that eliminates hazards and improves the safe operation of trains, vehicles, and pedestrians through a crossing and is authorized and funded by United State Code, Title 23, Section 130 Program funds.

R930-5-4. Type and Selection of Crossing Projects.

(1) Section 130 Crossing Projects:

(a) Section 130 Crossing Project types include, but are not limited to:

(i) Elimination of a Crossing by combining multiple Crossings;

(ii) Elimination of a Crossing by the relocation of a Highway;

(iii) Elimination of a Crossing by the construction of a new grade separation;

(iv) New safety improvements;

(v) Reconstruction of a Crossing grade separation structure;

and

(vi) Repair of Crossing material, that would otherwise be the responsibility of the Railroad as prescribed in Subsection R930-5-8-(1)(b), if the repair of the Crossing material affects or is an integral part of the Crossing safety devices.

(b) The Department has established a process for the evaluation and selection of Section 130 projects that considers the potential reduction in the number and/or severity of collisions, the cost of the Crossing projects, and available resources. Specific methods for selecting and prioritizing Crossings for improvement include:

(i) The collection and maintenance of data utilizing the USDOT Grade Crossing Inventory to record Crossing data including, but not limited to the current physical condition, average daily traffic, and collision data associated with a Crossing.

(ii) An engineering study conducted on a Crossing at the request of a Highway Authority, Railroad, or company or using a priority list developed using the USDOT Accident Prediction Model. The purpose of the engineering study is to review the Crossing and its environment, identify the nature of any deficiencies and recommend alternative improvements. Specifically, an engineering study reviews Crossing characteristics, the existing traffic

control system, and the Highway and Railroad characteristics. Based on the review of these conditions, an assessment of existing and potential hazards is made, deficiencies are identified and countermeasures are recommended.

(iii) System or corridor evaluations consider a Crossing as a component of a larger transportation system. The objective is to improve both safety and operations of the total system or segments of the system. In such cases, all Crossings within a corridor are evaluated and can be programmed for improvements. The optimal outcome of a corridor study involves a combination of engineering improvements and closures such that both safety and operations are highly improved.

(2) Non-Section 130 Crossing Projects:

(a) Non-Section 130 Crossing Project types include, but are not limited to:

(i) Crossing projects that use Railroad properties or involve adjustments to Railroad facilities required by Highway construction, but do not involve the elimination of hazards at a Crossing; and

(ii) Construction of a new Crossing at or over a Railroad track where the new Highway is not a relocation of an existing Highway.

(b) Non-Section 130 Crossing Projects will be evaluated and selected as part of the Department's normal STIP evaluation and approval process.

R930-5-5. Diagnostic Team.

(1) The role of the Diagnostic Team is to make recommendations to the Department for needed safety improvements at a Crossing.

(2) The Diagnostic Team reviews and evaluates proposed improvements for all Section 130 Crossing Projects and Non-Section 130 Crossing Projects. The Diagnostic Team reviews a Crossing when requested by a Highway Authority, Railroad, or Company when changes in Highway traffic patterns are proposed, when proposed Railroad traffic is determined to increase significantly, when complaints are made about a Crossing, when safety concerns arise, or when the Department receives a closure request. The Department will consider all recommendations made by the Diagnostic Team and, if appropriate, input received from the public at large (in accordance with Section R930-5-13) before issuing orders for the improvement of Crossings.

(3) The Department may also make formal findings and rulings as part of its process for evaluating Crossing improvements or during routine inspection of Crossings, independent of the Diagnostic Team.

(4) The Diagnostic Team is usually composed of the following team members:

(a) Chief Railroad Engineer for the Department;

(b) Representative from the Railroad;

(c) Representative from the appropriate Company, if applicable; and

(d) Representative from the Highway Authority (preferably from engineering or public works), and when available, and where

appropriate public school district, law enforcement agency and invites with an interest in the Crossing.

(5) The role of the Diagnostic Team is to:

(a) Recommend the elimination of a Crossing;

(b) Recommend the type of safety improvements including, but not limited to Passive Warning Devices, Active Warning Devices, the type of Crossing material, improvements to Highway approaches, removal of foliage and brush, pedestrian facilities (including compliance with ADA requirements), and improvements to street lighting;

(c) Review all requests for a new Crossing;

(d) Review all requests to reclassify a Crossing from private to public;

(e) Recommend the Department conduct an engineering study to evaluate the need for a new overpass or other grade separation structure(s); and

(f) Recommend any other safety related changes to improve vehicle and pedestrian safety.

(6) Duties of Diagnostic Team members generally include participating in Crossings reviews and providing input into the Diagnostic Team recommendations. Specific duties include, but are not limited to the following:

(a) The Chief Railroad Engineer will, when applicable:

(i) Select a Section 130 Crossing Project from a corridor study, or based on a Highway Authority, Railroad, or Company request;

(ii) Schedule and notify Diagnostic Team members, and the FHWA, of the date and time of an upcoming review;

(iii) Conduct Crossing review and issue related reports in a reasonable time after the review and send copies to all those attending the review;

(iv) Review and approve Crossing improvements recommended by the Diagnostic Team;

(v) Determine Section 130 apportionments for Crossing projects;

(vi) Initiate all Notices of Intended Action for Crossing projects, as appropriate;

(vii) Review and approve the contractual requirements for Crossing projects using Section 130 Program funding;

(viii) Review all necessary field data obtained for the Crossing, including but not limited to site plan maps and photographs of the existing Crossing conditions.

(b) The Railroad representative shall provide all relevant data related to the Crossing, including, but not limited to train volumes, accident data and any other pertinent data regarding the Crossing;

(c) The Highway Authority representative shall:

(i) Provide relevant data regarding the Crossing including, but not limited to Highway traffic volumes, planned road construction activities, and an approved master street plan for the Highway;

(ii) Invite local school district if appropriate and request that the local school district representative provide child access and bus routing plan information; and

(iii) Invite local law enforcement agency if appropriate and request that the law enforcement agency provide relevant data, including, but not limited to any safety concerns about the Crossing.

R930-5-6. Design of a Highway-Rail Grade Crossing.

(1) The Department shall approve or disapprove, as appropriate, the design of all Crossing improvements, including the addition of a new Crossing and treatments for a closed Crossing. All design plans shall include, if available:

- (i) USDOT identification numbers;
- (ii) Street addresses;
- (iii) Highway milepost;
- (iv) Railroad subdivision; and
- (v) Railroad milepost for the Crossing.

(2) Design of Crossing related facilities that are the responsibility of the Railroad shall conform to the specifications and design standards of the Railroad.

(3) Design of Crossing related Highway approaches, those areas two feet outside of rail that are the responsibility of the Highway Authority shall conform to the specifications and design standards of the Highway Authority, subject to approval by the Department. Where a Highway Authority does not have an approved standard, Department standard drawings for the design of the Crossing approaches apply.

(4) Traffic control devices installed as part of any Crossing improvements shall comply with the MUTCD. Required clearances for all devices shall conform to the MUTCD and any variances from MUTCD requirements must be approved by the Department.

(5) When it is determined that the railroad crossing material needs to be extended or replaced, the agency doing the design of the crossing shall determine the minimum length of the crossing material. The length shall be determined based on the proposed width of the new roadway or from the approved master plan roadway width. The crossing material length shall extend at least two feet from the outer edge of the roadway, beyond the roadway clear zone area, or to the back of the concrete curb and gutter or out past the sidewalks.

(6) The Railroad is responsible for the design of Railroad Active Warning Devices, including the location, activation circuitry, hardware, and software in accordance with MUTCD.

(a) When Active Warning Devices are within 200 feet of a traffic signal, the Highway Authority and the Railroad shall coordinate the design of the interconnect between the traffic signal and Automatic Warning Device to ensure sufficient preemption time to clear potential vehicle stacking across a Crossing.

(b) Signal houses for Active Warning Devices shall be located in the Neutral Quadrant unless approved by the Department.

(7) The Railroad is responsible for the design of all required Railroad Passive Warning Devices located within the Railroad road right-of-way in accordance with the MUTCD, specific Passive Warning Devices include:

- (a) Sign R15-1 (Crossbuck);
- (b) Sign R15-2 (Number of tracks);
- (c) Sign R1-1 (STOP);
- (d) Sign R1-2 (Yield);
- (e) Sign R15-3 (Exempt);
- (f) Sign R8-9 (Tracks out of Service).

(8) Design and installation of all other Passive Warning Devices, signs, and pavement markings is the responsibility of the Highway Authority. Design and location of the devices shall be in accordance with the MUTCD.

(9) For clearances, refer to the Manual for Railway Engineering, Chapter 28, Clearances, American Railway Engineering and Maintenance-of-Way Association (AREMA), 2007.

R930-5-7. Highway Authority and Railroad Responsibility to Request Approval and Arrange for the Installation of Crossing Improvements.

(1) When a Highway Authority widens or constructs a new Highway, the Highway Authority shall be responsible to request a Diagnostic Team review of the Crossing and arrange by agreement with the Railroad to design and install all required improvements concurrent with its request for approval from the Department:

(2) Prior to approving new residential, commercial, or industrial development within 1000 feet of a Crossing, the Highway Authority shall request a Diagnostic Team review to assess the potential traffic impacts at the Crossing.

(3) Before a Highway Authority approves increased development that changes the conditions of a Crossing by significantly increasing traffic volumes, the Highway Authority plans shall be approved by the Department.

(a) No new access openings can be opened within 250' of a Crossing unless approved by the Department.

(b) The Highway Authority shall arrange by agreement with the Railroad for any required Railroad facility changes ordered by the Department.

(4) The Highway Authority is responsible for the installation of all Passive Warning Devices outside the Railroad right-of-way, excepting those signs listed in Section R930-5-6.6, or unless a separate agreement applies.

(5) Before a Railroad modifies any safety related devices or the physical layout of a Crossing, the Railroad shall request a Diagnostic Team review of the proposed changes and request Department approval of all Crossing related designs.

(6) A Highway Authority, Railroad, or Company making a request for a new Crossing or the reclassification of a Crossing from private to public shall provide the Department with an approved master street plan from the appropriate jurisdiction showing the elimination or combination of existing Crossings and/or other safety improvements that enhance the overall safety of the corridor before a new Crossing or reclassification of a Crossing from private to public will be approved.

(a) A Highway Authority, Railroad, or Company requesting a new Crossing or reclassification of a Crossing from private to public will mutually arrange by agreement for the proposed new

Crossing or reclassification of a Crossing before seeking Department approval of the change.

R930-5-8. Maintenance.

(1) Responsibility for maintenance is as described in this section unless a separate agreement applies.

(a) The Railroad is responsible for the maintenance of all Railroad Passive Warning Devices and Active Warning Devices within the Railroad right-of-way.

(b) If the Railroad has a property interest in the right-of-way, the Railroad is responsible for the maintenance of Crossing material within the Railroad right-of-way and two feet beyond each outside rail for Crossings without concrete crossing panels or edge of concrete crossing panel.

(c) On a temporary Highway Detour Crossing, the Railroad shall be responsible for the maintenance of pavement, Active Warning Devices, and Passive Warning Devices within the Railroad right-of-way at expense of the Highway Authority.

(d) When the Railroad alters the railway due to track and ballast maintenance, the Railroad shall coordinate their work with the Highway Authority so the pavement approaches can be adjusted to provide a smooth and level Crossing surface.

(e) When the Highway Authority changes the Highway profile, through construction or maintenance activities, the Highway Authority shall coordinate their work with the Railroad so the tracks can be adjusted to provide as smooth and level a Crossing surface as possible.

(f) Where a Highway structure overpasses a Railroad, the Highway Authority is responsible for the maintenance of the entire structure and its approaches.

(g) Where a Highway underpasses a Railroad and the Railroad owns the right-of-way in fee title, the Highway Authority is responsible for the maintenance of the Highway and the entire structure below and including the deck plate, girders, handrail, and parapets. The Railroad is responsible for the maintenance of the ballast, ties, rails and any portion of the supporting structure above the top of the ballast deck plate between parapets.

(i) If the Highway Authority owns the right-of-way in fee title, the Railroad is responsible for the maintenance of the entire structure unless a separate agreement applies.

(ii) Cost of repairing damages to a Highway or a Highway structure, occasioned by collision, equipment failure, or derailment of the Railroad's equipment shall be borne by the Railroad.

(h) Responsibility for maintenance of private industrial trackage not owned by a Railroad that crosses a Highway shall be as follows:

(i) When a facility, plant, or property owner receives goods and services from a Railroad over private industrial trackage that crosses a Highway, maintenance of the Crossing shall be the responsibility of the industry owning the trackage, or as agreed to by the parties.

(ii) When the Crossing becomes a safety hazard to vehicles

and is not maintained, the Department and/or the Railroad shipping the goods and services shall notify the industry owning the trackage in writing to maintain or replace the Crossing material.

(iii) If the industry owning the trackage does not maintain or replace the Crossing material by a specified date, the Department shall order the Railroad to cease and desist operations across the Crossing.

(iv) If the industry owning the trackage does not respond to the order to maintain or replace the Crossing material the Department shall arrange to have the Crossing material replaced and bill the industry owning the trackage for the expenses to repair the trackage.

R930-5-9. Funding Authorization and Apportionment of Cost for Section 130 Crossing Projects.

(1) Funding Authorization.

(a) Section 130 Crossing Projects:

(i) Costs associated with a FHWA authorized and approved program are eligible for federal participation. Eligible costs incurred in an approved program prior to authorization by FHWA are not reimbursable, but may be included as part of the Railroad share of the project cost where such a share is required. Eligible costs include, but are not limited to cost associated with environmental clearance, Preliminary Engineering, and right-of-way acquisition.

(ii) Prior to FHWA issuing its authorization to advertise the construction of a Crossing project, the Crossing project must receive environmental clearance; the plans, specifications and estimates must be approved by FHWA; and any proposed agreement between the Railroad and the Department must be reviewed and approved by FHWA, as per FHWA's stewardship agreement with the Department.

(b) Non-Section 130 Crossing Projects:

(i) The Department will consider requests for funding of non-Section 130 Crossing Projects as part of its regular STIP evaluation and approval process.

(2) Apportionment of Costs.

(a) Section 130 Crossing Projects:

(i) Apportionment of costs for installation, maintenance, and reconstruction of safety related improvements at a Crossing shall be in accordance with 23 CFR 646 and Section 54-4-15.

(ii) When a Highway Authority widens a Highway, the Highway Authority shall fund all improvements including, but not limited to Passive Warning Devices, Active Warning Devices, Crossing material, and other improvements as ordered by the Department in consultation with the Diagnostic Team.

(iii) The Department will evaluate each Crossing project to determine the extent to which, if any, the Crossing projects benefits the respective parties. If a Crossing project is determined not to benefit a party, the party will not be required to participate in the funding.

(b) Non-Section 130 Crossing Projects.

(i) The Department will consider requests for funding of non-Section 130 Crossing Projects as part of its regular STIP

evaluation and approval process.

R930-5-10. Railroad and Highway Authority Agreements.

(1) Where construction of a Section 130 Crossing Project requires use of Railroad properties or adjustments to Railroad facilities, the Department will prepare an agreement with the Railroad.

(2) Master agreements between the Department and a Railroad on an area wide or statewide basis may be used. These agreements shall contain the specifications, regulations, and provisions required in conjunction with work performed on all Crossing projects.

(3) On a project-by-project basis, the written agreement between the Department and the Railroad shall include the following minimum requirements:

- (a) Reference to appropriate federal regulations;
- (b) Detailed statement of the work to be performed by each party;
- (c) The extent to which the Railroad is required to adjust its facilities;
- (d) The Railroad's share of the project cost;
- (e) An itemized estimate of the cost of the work to be performed by the Railroad;
- (f) Method to be used for performing the work, either by Railroad forces or by contract;
- (g) Maintenance responsibility;
- (h) Form, duration, and amounts of any needed insurance; and
- (i) Appropriate reference to or identification of plans and specifications.

(4) On matching fund agreements between the Department and a Highway Authority, the written agreement shall include the following minimum requirements:

- (a) Description of work and location, city, county, and state;
- (b) Reference to federal regulations that matching funds will be provided by the Highway Authority;
- (c) Detailed statement of work to be performed by each party regarding design, agreements, inspection, and maintenance;
- (d) Statement of finances of project and matching funds to be provided by Highway Authority, deposits, invoices, and cost overruns or under runs.

(5) Agreements for industry track Crossings are prepared between the Highway Authority and the industry.

(6) In order that a Crossing project shall not become unduly delayed, the Department shall consider a six-month period from issuance of the Railroad agreement to be adequate for completion of work by the Railroad involved. Should more than the specified period elapse, the Department shall require the Railroad to proceed with the work covered by the agreement under the authority contained in Section 54-4-15 and approval from the FHWA will be solicited in conformance with 23 CFR 646.

R930-5-11. Crash Reporting.

A Railroad is required to report crashes resulting in injury

or death to an individual or damage to equipment, roadbed, or autos occurring at a Crossing to the Department's Chief Railroad Engineer within 2 hours of the incident. Initial notification must include the USDOT Crossing number, street address, municipality, time of incident, train identifier, and contact phone number for further information. Written crash reports shall be submitted to the Department within 30 days of the incident. Current Federal Railroad Administration (FRA) form F 6180.57 shall be used to report a crash.

R930-5-12. Exemption of Railroad Crossings.

Under Section 41-6a-1205, certain vehicles are required to stop at all Crossings unless a Crossing is signed as exempt. Recommendation to exempt a Crossing is made by a Diagnostic Team and the Department is responsible for issuing the exemption order.

The following Crossings are not eligible for exemption under this Section:

- (1) Mainline Crossings with Passive Warning Devices only;
- (2) Crossings within approved Quiet Zones; and
- (3) Crossings where insufficient sight distance exists.

R930-5-13. Notice of Intended Action.

(1) Public notification of a public hearing opportunity is required, in conformance with Section R930-2, when the Department is considering a proposal to close a Crossing, add a track at a Crossing, or construct a new Crossing. It is the responsibility of the Highway Authority, Railroad, or Company requesting the proposed action, in consultation with the Department, to carry out the requirements of this section unless otherwise agreed to by the Department.

(2) In instances where the action proposed by the Department does not substantially affect the public, the Department may waive the requirement to notice a public hearing opportunity, provided the affected Diagnostic Team members concur in writing.

KEY: railroad, crossing, transportation, safety

Date of Enactment or Last Substantive Amendment: February 8, 2010
Authorizing, and Implemented or Interpreted Law: 41-6a-1205; 54-4-14; 54-4-15; 72-1-201

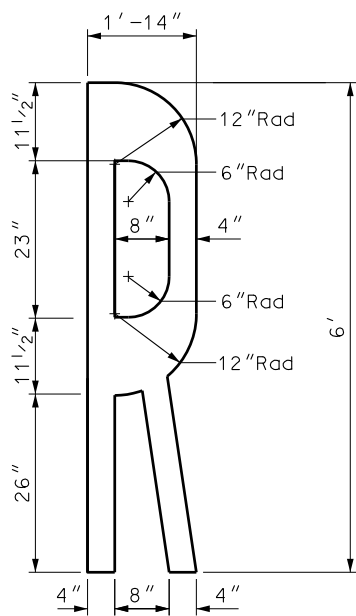

SPACING TABLE	
SPEED LIMIT MPH	MIN. DISTANCE (feet)
65 - 70	750
55 - 60	550
45 - 50	375
35 - 40	225
25 - 30	100

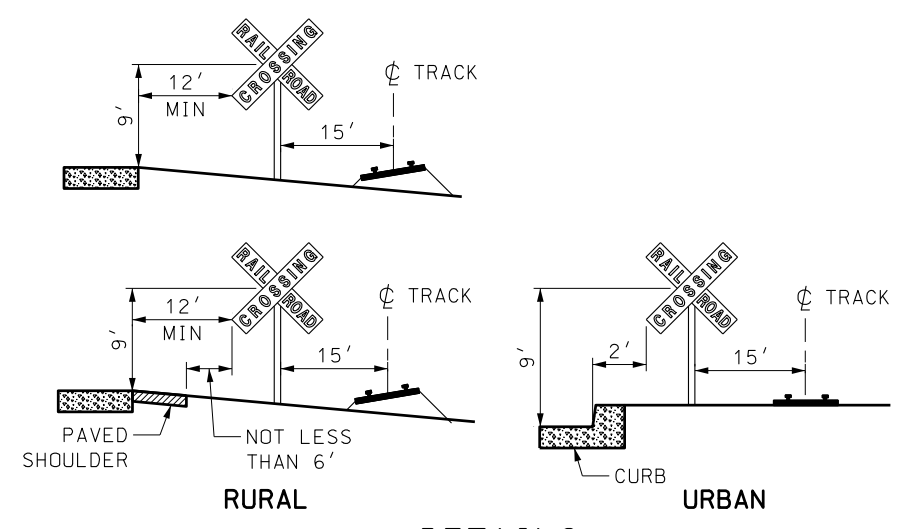
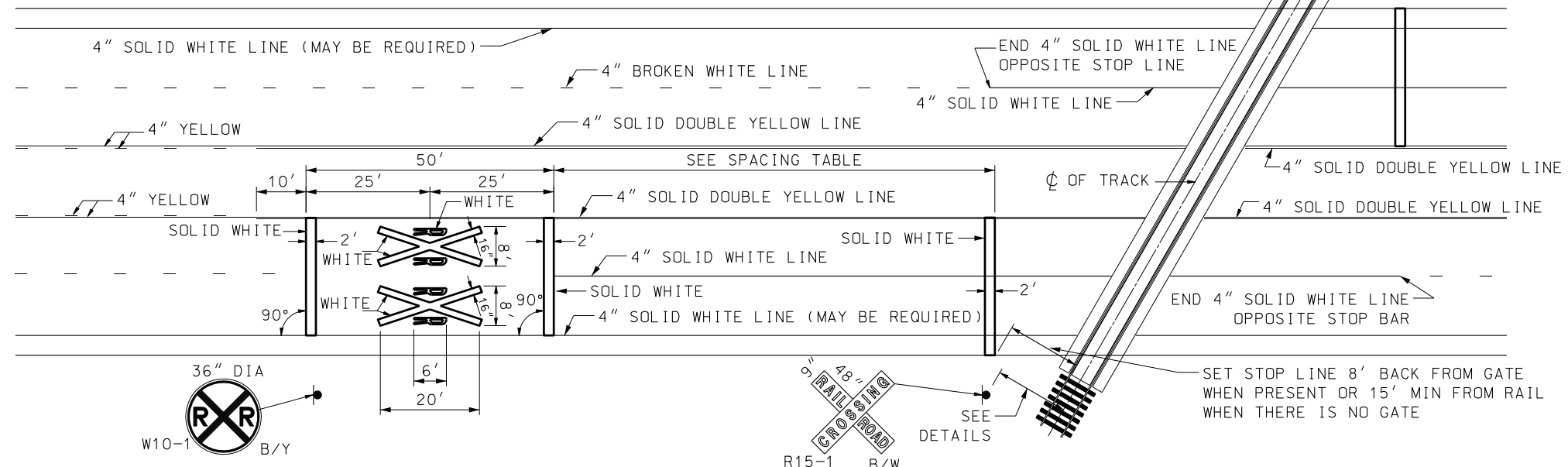
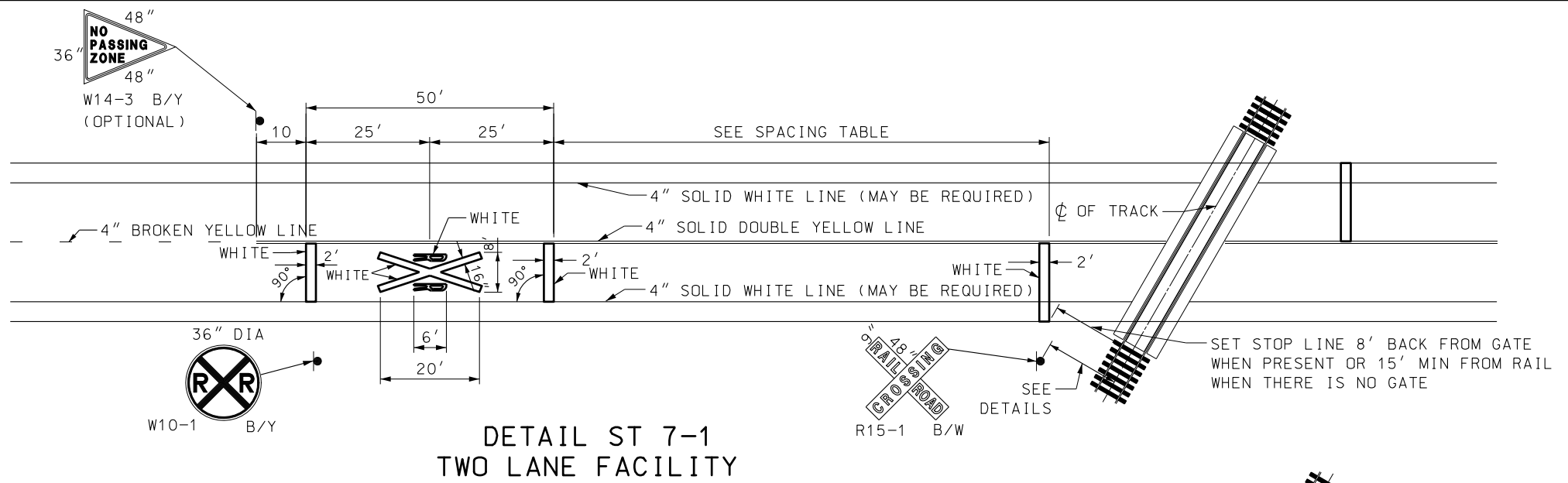
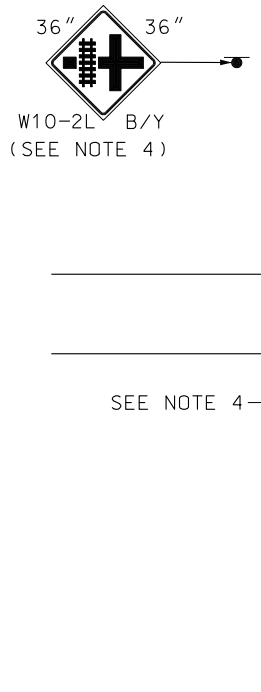

- NOTES:**
1. PLACE PAVEMENT MARKINGS CONSISTING OF AN "RXR", TRANSVERSE LINES, AND NO-PASSING MARKINGS. USE MARKINGS IN EACH APPROACH LANE ON ALL PAVED APPROACHES TO GRADE CROSSING WHERE GRADE CROSSING SIGNALS OR AUTOMATIC GATES ARE PRESENT AND AT ALL OTHER GRADE CROSSINGS WHERE THE POSTED SPEED IS 40 MPH OR GREATER. PLACE PAVEMENT MARKINGS AT OTHER CROSSINGS AS DIRECTED BY THE REGION TRAFFIC ENGINEER.
 2. EXTEND TRANSVERSE LINES ACROSS ALL APPROACH LANES ON MULTI-LANE ROADS. USE INDIVIDUAL "RXR" MARKINGS IN EACH APPROACH LANE.
 3. USE THE STANDARD HIGHWAY SIGNS MANUAL FOR DIMENSIONS OF "RXR" PAVEMENT MARKINGS.
 4. PROVIDE W10-2L AND W10-2R SIGNS MANUAL WHEN DISTANCE BETWEEN NEAREST RAIL AND EDGE OF ROADWAY IS 100 FEET OR LESS.

NO.	DATE	APPR.	REMARKS

UTAH DEPARTMENT OF TRANSPORTATION
 STANDARD DRAWINGS FOR ROAD AND BRIDGE CONSTRUCTION
 RECOMMENDED FOR APPROVAL
 JAN. 01, 2008
 CHAIRMAN STANDARDS COMMITTEE
 DEPUTY DIRECTOR

PAVEMENT MARKINGS AND SIGNS AT RAILROAD CROSSING
 STANDARD DRAWING TITLE

18-DEC-2007 DGN File: L:\Standard Drawings\Impenal\2008\approved\ST7.dgn

**Railroad Crossing Application
Utah Department of Transportation**

Current average daily road traffic: _____	Operating railroads at this crossing: _____	Application Date: _____
---	--	----------------------------

Current average rail traffic : _____	Owning railroad: _____	If existing crossing, give DOT number: _____
---	------------------------	---

Approximate Street Address & City: Approximate Railroad Milepost and Subdivision:	Applicant: Name: Address: Phone #:
--	---

Reason for request:

Note that UDOT may require additional information as the crossing application is reviewed and processed.

<p>Attach the following information</p> <ol style="list-style-type: none"> Copy of master plan from city, clearly showing the proposed crossing Proposed crossings to be closed Engineering drawing (8.5x11 or 11x17) of proposed crossing must include: <ul style="list-style-type: none"> Next adjacent streets Other accesses within 250 ft Sight obstructions (buildings, trees, etc.) Number of lanes and number of tracks Smallest angle between centerline of track, centerline of road US DOT number, railroad milepost, railroad subdivision 	<p>Submit application to:</p> <p>Utah Department of Transportation Office of Railroad Safety 4501 South 2700 West Salt Lake City, UT 84114-8445</p> <p>Office: 801-965-4176 Fax: 801-965-4564</p>
---	---

INTERNAL UDOT USE ONLY	Diagnostic/Surveillance Date: _____	Application Status:
	DM# _____	Denied: _____
Received:	Private/Public Conversion? Yes No	Authorized: _____
		DM# _____

NOIA Date: _____, DM# _____	PSC Appeal Date: _____, DM# _____
PE Auth to RR: _____, DM# _____	PSC Ruling Date: _____, DM# _____
NTP for Const.: _____, DM# _____	

Accomplishment of and Payment for Utility Relocations Required in Connection with Highway Work (Including Railroad Relocation)

UDOT 08B-29

Effective: June 20, 1977

Revised: April 15, 2006

Purpose

To establish a policy for the preparation and administration of Agreements with utility and railroad companies for the relocation, reconstruction or protection of their facilities in connection with highway work and the reimbursement of their costs, exclusive of betterment and salvage credits.

Policy

UDOT will prepare agreements for relocation of utility facilities and the protection or reconstruction of railroad facilities required in connection with highway work. Reimbursement of their costs, exclusive of betterment and salvage credits, will be made as required by State Law and Federal regulations.

Definitions

Utility: In all cases where the word utility is used in this policy and procedure, the word "Utility" is synonymous with railroad companies.

Procedures

Accomplishment of and Payment for Utility Relocations Required in Connection with Highway Work

UDOT 08B-29.1

Responsibility: Region Utility and Railroad Coordinator

Actions

1. In coordination with the Project Design Engineer, determines the need for relocation, reconstruction or protection of utility and railroad facilities.
2. Negotiates, prepares and executes necessary agreements, including descriptions, estimates of cost and drawings, for the completion and reimbursement of costs associated with the required work.
3. Requests Federal Highway Administration approval for expenditure of funds necessary to accomplish utility or railroad relocation.
4. Makes distribution of executed utility or railroad agreements to Region Director for signature. Sends the utility or railroad agreements to the Comptroller for payment.

Responsibility: Contracts, Estimates and Agreements Manager (Is responsible for monitoring administration of work under utility/railroad agreements.)

5. Initiates Utility Fiscal Review Report, Form C-193, Page 1, on all utility and railroad agreements where payment is to be made to the utility or railroad under the terms of the agreement.
6. Reviews billing (both partial and final) from utility company or railroad for work accomplished and forwards to appropriate Resident Engineer for verification.

Responsibility: Resident Engineer

7. Receives and reviews daily force account records and accomplishes physical inspection for all work accomplished by utility and railroad company forces. Records salvage value of material removed and not incorporated into the new work. Obtains FHWA approval of salvage value.
8. Upon receipt of billing reflecting a partial payment of the work required, verifies completion of work being billed, based on the daily records, and with original agreement and returns verified billing to the Contracts, Estimates and Agreements Manager.

9. In those instances where additional work not covered by the original agreement is found necessary to complete the relocation as planned, prepares a supplemental agreement or change order to obtain approval from FHWA for the additional items of work.
10. Upon receipt of billing reflecting final payment, completes Form C-193, Page 2, and C-193A, insures all documentation to support the payment is complete and forwards the complete package (including daily records, change orders, pertinent notes, etc.) to the Region Contracts Specialist.

Responsibility: Region Contracts Specialist

11. Insures complete review of the final billing against the original agreement. Verifies adequacy of documentation to support the final payment requested by signing Form C-193, Page 2. Obtains Region Construction Engineer's signature of approval on Form C-193 and forwards the complete package to the Contracts, Estimates and Agreements Manager.

Responsibility: Contracts, Estimates and Agreements Manager

12. Processes billing for payment as follows:
 - a. Partial billings - Upon receipt of verified partial billing from the Resident Engineer, determines that all work is verified as billed and forwards to the Comptroller for payment.
 - b. Final Billing - Reviews Form C-193 and related documentation against the billing. Insures documentation will meet Federal Highway Administration requirements for federal participants, when applicable, and meets the Construction Manual of Instruction requirements.
 - c. Where differences between the billing and the documentation appear to exist, other than costs which were incurred off the site of the work such as engineering overhead, that cannot be corrected by the Resident Engineer or verified by the utility, forwards final billing and related documentation to the Internal Auditor with a letter of transmittal setting forth those differences which cannot be reconciled and requests that the Internal Auditor review the utility company or railroad's documents which support the billing.

- d. Where the Resident Engineer's documentation supports the billing, forwards the billing to Comptroller for payment. At the same time, forwards copy of billing and related documentation to the Internal Auditor requesting an audit of the utility company or railroad records to support the final payment. Note: In those instances where the agreement between UDOT and the utility company or railroad does not provide for the return of overpayment disclosed as a result of an audit, final billings and related documentation must be routed through the Internal Auditor prior to payment.
- e. For those agreements where the amount to be paid to the utility or railroad is a lump sum amount set forth in the executed agreement, the final billings approved by the Resident Engineer may be forwarded directly to the Comptroller for payment without a request for audit.

NOTE: The audit package sent to the Internal Auditor by the Contracts, Estimates and Agreements Manager will contain the following items: Copies of the approved billing, the completed Fiscal Review Report, Form C-193, copy of the executed agreement, copy of the authorization to proceed, signed copies of any Change Orders or Supplemental Agreements including all exhibits, daily records (when available), reports on salvaged material when credit for salvage is due and any pertinent correspondence. (FHWA approval will be reflected on all applicable agreements and change orders.)

Responsibility: Internal Auditor

- 13. Where a final billing has previously been paid, reviews final billing as necessary to issue Certificate of Audit. When necessary, reviews the utility company records to support charges listed on billing. For out-of-state companies, arranges for audit to be performed by another State when appropriate. Where advance payment has resulted in either an overpayment or underpayment, recommends action be taken by the Comptroller to adjust the final payment amount.
- 14. Where final payment has not yet been made, reviews final billing as necessary to issue Certificate of Audit and forwards to Comptroller for payment. When necessary reviews the utility company records to support charges listed on billing. When review of an out-of-state company records is required, requests review be made by an auditing agency of the State where the records are located.

Responsibility: Comptroller

- 15. Where Certificate of Audit supports amounts previously paid and no added payment is necessary, processes billing to Federal Highway Administration for federal reimbursement when applicable.

16. When Certificate of Audit indicates additional payment is due the utility or railroad, prepares Road Cost Distribution to effect payment to the utility company or railroad. Billing is then processed to the Federal Highway Administration for federal reimbursement when applicable.
17. When the Certificate of Audit indicates the advance payment made to the utility resulted in an overpayment, bills the utility for the amount of the overpayment and maintains follow-up until the amount of the overpayment is received.



State of Utah

GARY R. HERBERT
Governor

GREG BELL
Lieutenant Governor

DEPARTMENT OF TRANSPORTATION

JOHN R. NJORD, P.E.
Executive Director

CARLOS M. BRACERAS, P.E.
Deputy Director

MEMORANDUM

DATE: April 27, 2011
TO: All UDOT Employees
FROM: Rex Harris, Statewide Utilities Engineer 
SUBJECT: Utility Relocation Policies

The following are clarifications of UDOT policies involving utility relocations on all State and Federal Oversight projects, regardless of funding source. These policies will be included in the New Utilities Manual of Instruction due out later this year.

Aerial Easements

Whenever an overhead utility facility is relocated during a State or Federal Oversight project, it must be protected during all phases of the project, including its final location within State right of way, State owned easement, Utility owned right-of-way or easement, or by legal right granted by an authorized political subdivision of the State of Utah. This protection is required for all above ground utilities regardless if the utility facility is considered a transmission, distribution, or any other line conveyance.

Purchasing Right-of-Way/Easements for Utility Companies

Utility companies must be 'functionally restored' if they are relocated as the result of a project. When considering property rights, the concept of functionally restoring means to provide the utility company with the same legal rights and operating capabilities after a project as they had before. In cases where this is not possible, every effort must be made to provide the utility company with something equitable. The following should give direction for specific examples. Any deviations from the stated cases below must be approved through the Statewide Utilities Engineer. As a note of importance, establishing Vested Rights Agreements are not an authorized standard UDOT practice:

1. Utility facilities located within State rights-of-way by Permit and entitled to 50% reimbursement should be relocated within State rights-of-way where possible, with the same permitting stipulations that applied before the relocation.
2. Easements purchased on behalf of utility companies for relocations that are eligible for 50% reimbursement should be purchased in the name of the State.
3. Utilities that are located in a utility company owned right-of-way should be relocated within replacement right-of-way purchased by the project in the name of the Utility Company. If this is not possible or if the utility company is agreeable, a License can be granted by the State to place the utility facility within State right-of-way. These relocations and any future relocations under this scenario are reimbursed at 100%.
4. In the unlikely event that a utility facility is located in a utility owned easement within State right-of-way, it should be relocated back within State right-of-way with a License Agreement. These relocations and any future relocations under this scenario are reimbursed at 100%.

Betterments

The Code of Federal Regulations (CFR) defines a betterment as any upgrading of the facility being relocated that is not attributable to the highway construction and is made solely for the benefit of and at the election of the utility (23 CFR 645.105). Best efforts shall be made to accommodate utility betterments during construction projects as long as the betterment does not negatively impact the project schedule, either during design or construction. It is in the best interest of both the utility company or local government, and the department to upgrade or update existing facilities in conjunction with highway projects due to reduced costs for the work and the elimination of greater impacts to the roadway and the users caused by replacing utility facilities after the roadway has been reconstructed. The two year moratorium on cutting new pavements should be considered when coordinating with utility owners on projects.

Variances and Design Exceptions

All utility relocation designs that do not meet AASHTO and/or UDOT Design Standards for Location, Depth of Bury, Encasement, Clear Zone or Vertical Clearance must be approved through the normal design standard exception or design acceptance procedures, whichever is applicable. In addition to this, the Statewide Utilities Engineer shall be notified so that he can work with the State Preconstruction Engineer in determining where variances or design exceptions are appropriate.

Designing Rights-of-Way/Easements

Fairness and engineering judgment should be used in determining when rights-of-way or easements should be purchased to accommodate utility relocations on projects. Special attention should be given to the functionality and costs of these facilities, as well as schedule impacts associated with requiring utility companies to acquire replacement rights-of-way for themselves. First consideration should be given to minimizing relocations and/or relocating facilities within existing rights-of-way or easements.

Utility Right of Way Standards

The State will honor Utility Company standards for ROW width as long as they are reasonable, necessary, and consistent with industry standards. All standards that do not appear to meet this description shall be brought to the attention of the Statewide Utilities Engineer for review and approval.

January 1, 20XX

Mr./Mrs. XXXXXXXX
Railroad Project Manager
XXX South XXX West
Salt Lake City, UT 84XXX

**Re: Authorization for Preliminary Engineering
Project:
Project Address, (DOT# 123-456X)**

Dear XXXX,

This letter serves as your authorization to conduct preliminary design engineering for required improvements to railroad crossings at the locations specified above on the XXXX Railroad line in the City of XXXXXXX, Utah. The total amount of design charges is not to exceed \$10,000 per crossing. Required improvements are to be made to the following crossings:

Project Name/Address: (DOT# 123-456X)

I have attached the surveillance report that also outlines the required improvements. If you have questions please email me at echeng@utah.gov or give me a call at 801-965-4284

Sincerely,

Eric Cheng, P.E.
Chief Railroad Engineer

January 1, 20XX

Mr./Mrs. XXXXXXXX

Title

Organization

XXX South XXX West

Salt Lake City, UT 84XXX

Subject: Surveillance Report: *Project Name*
Crossing Nos.: DOT# 123-456X

Dear: XXXX,

In accordance with Utah Administrative Rule R930-5, a highway railroad grade crossing surveillance review was conducted on *January 1, 20XX* for the above stated crossings near *City, UT*.

Review Team:

Provide names, titles and organizations of all persons attending the surveillance review.

Background information:

Provide background information on the crossing, being sure to identify the history of the crossing, the reason for the surveillance review, any additional information useful to the report.

General Recommendations:

- 1. Provide a list of general items that need to be in place at crossing. This could consist of items that are common to multiple crossings or items not necessarily directly related to the crossing.*

Specific Recommendations:

(DOT# 123-456X) Address.

- 1. List all items that need to be performed at the crossing, i.e. signage placement, pavement marking refreshing or placement, engineering studies to be performed, preemption, etc...*

If you have any questions regarding this letter, please feel free to contact me at 801-965-4284.

Sincerely,

Eric Cheng, P. E.
Chief Railroad Engineer

Cc: *All attendees from the review team as well as any others necessary to the project.*

UTAH DEPARTMENT OF TRANSPORTATION UTILITY CONTRACT OVERRUN FUNDING NEED (uCOFN)
--

Project No.		Pin No.		Agreement No.	
Utility Co:		Auth No.:		Request No.	
Date:				Estimate No.	

Basis for Request of Authorization Covering Overrun in Contract Amount (List all Change Orders\Items Overrunning and Amounts for this request:)				
CO. Nos:	Amount:	Items Overrunning	Amount	Total:
	0		0	0
Estimated Time Table:	Month		Total Request:	0

	DEPARTMENT OF TRANSPORTATION
ORIGINAL CONTRACT AMOUNT:	_____ Resident Engineer Date
PREVIOUS COFN's:	Project Funds Availability
TOTAL COFN's: (including this one)	Avail. <input type="checkbox"/> Needed <input type="checkbox"/>
TOTAL Authorized Amount: (Original Contract Amt plus COFN's)	_____ Project Manager Date
Percent of Supplemental Authorizations:	Funding Need Acknowledged
COMMENTS:	_____ Program Finance Office Date
	Payment Processed
	_____ Comptrollers Office Date
_____ Processed in Central Construction Date	

UTILITY FISCAL REVIEW REPORT

Project Number:
Utility Company:

RESIDENT ENGINEER

1. Relocation Completion Information:

a. Date Work Started:	
b. Date Work Completed:	
c. Date of Verification of Work Completed:	

2. Comparison of Estimate Billing:

	Estimated	Billing	Difference
a. Labor			\$0.00
b. Materials			\$0.00
c. Salvage Credits			\$0.00
d. Equipment			\$0.00
e. R. O. W.			\$0.00
f. Overhead			\$0.00
g. Engineering			\$0.00
h. Miscellaneous			\$0.00
i. Other			\$0.00
Change Order No.			\$0.00
Change Order No.			\$0.00
Total	\$0.00	\$0.00	\$0.00
Less Company's Share _____ %			
States Share _____ %			

NOTE: Major Differences Should be Explained: (use back of form if necessary)

The project records were reviewed and found to be adequate for support of final payment. The Utah Department of Transportation certifies that the work is complete, acceptable, and in accordance with the terms of the agreement.

/ /		/ /	
Date	Resident Engineer	Date	District Engineer

SALVAGE CREDIT REPORT FOR UTILITIES AND RAILROADS

_____ 19 _____

Project No.: _____ Authority No.: _____

Location: _____

Name of Utility or Railroad: _____

Agreement No.: _____ Date of Agreement: _____

Salvage costs of any material will be deducted from the billings to U.D.O.T. Please fill in the following blanks and return this form with the enclosed bill through the District Engineer to the Construction Division, c/o Contracts, Estimates and Agreements Manager.

1. If the bill shows no credit due the State, should it have shown such credit?

Yes _____ No _____

2. If so, or if credit is shown for such materials, were you notified in writing by the utility or railroad company of the time and place that the required inspection of recovered materials could be made?

Yes _____ No _____

3. Did you make such inspection:

Yes _____ No _____

4. If not, why?

5. What is the status of the salvaged material, ie., was it scrapped, junked, sent to storage, etc.:

(Complete Item No. 6 if applicable. Utility or Railroad must sign if applicable.)

6. It was determined by the above listed utility or railroad that the materials removed had no salvage value.

Utility or Railroad Representative ___/___/___
Date

Date

Resident Engineer

Date

District Engineer

OVERHEAD SUBMITTAL CHECKLIST

<input type="checkbox"/>	PRELIMINARY PLANS		SUBMITTED BY:
<input type="checkbox"/>	FINAL PLANS		DATE:

PROJECT NAME:

LOCATION:

MILE POST:

SUBDIVISION:

Support	Item	Min. Req'd	Design	Accepted	Rejected	Remarks
Pier No. 1	Horizontal Clearance (Left) (CL to Face)	18'-0"				
	Horizontal Clearance (Right) (CL to Face)	18'-0"				
	Vertical Clearance (From T/R)	23'-0"				
	Hz.Cl. Of Ftg. From CL tracks for ftg.<6' deep	25'-0"				
	Pier Footing Depth Below B/R	6'-0"				
	Crash Wall Required (CL to Face)	25'-0"				
	Shoring Required (CL to Nearest Pt.)	12'-0"				
Pier No. 2	Horizontal Clearance (Left) (CL to Face)	18'-0"				
	Horizontal Clearance (Right) (CL to Face)	18'-0"				
	Vertical Clearance (From T/R)	23'-0"				
	Hz.Cl. Of Ftg. From CL tracks for ftg.<6' deep	25'-0"				
	Pier Footing Depth Below B/R	6'-0"				
	Crash Wall Required (CL to Face)	25'-0"				
	Shoring Required (CL to Nearest Pt.)	12'-0"				
	Existing Track Centers					
	Future Track Center	20'-0"				

	Splash Boards or Barrier Rail (Left)	5'-0"/3'-6"				
	Splash Boards (Right)	5'-0"/3'-6"				
	Splash Boards Limits Adequate	R/W to R/W				
	Fence (w/Pedestrian Walkway)	8'-0" or 10'-0"				
	Fence (w/o Pedestrian Walkway)	10'-0"				
	Fence Limits Adequate	R/W to R/W				
	Slope Protection	> 2:1				
	Adequate Drainage (Left)	--				
	Adequate Drainage (Right)	--				
	Drain. from Str. / Leaders at Bents only	--				

Support	Item	Min. Req'd	Design	Accepted	Rejected	Remarks
	Access Road (25' from CL to Face)	25'-0"				
	RR R/W Shown Correctly	—				
	ALL Tracks Labeled Correctly	—				
	Existing Utilities Aerial or Underground	—				
	Max. Gap Between Structures	2'-0"				
	Lights Required for Width of Str. over 80'	80'-0"				
	Track profile on either side of structure	1000'				
	Demolition Required	—				
OTHER	Temporary Vertical Clearance (From T/R)	21'-0"				
	Temporary Horiz. Cl. (Falsework Bent)	12'-0"				

INSTRUCTIONS:

FILL ALL APPLICABLE PARTS OF TABLE ABOVE: " DESIGN" INSERT ALL APPLICABLE MINIMUM VALUES FROM PLANS.

"ACCEPTED" PLACE AN "X" IF REQUIREMENTS ARE MET.

" REJECTED" PLACE AN "X" IF REQUIREMENTS ARE NOT MET.

" REMARKS" LIST YOUR COMMENTS

PRELIMINARY PLAN REVIEW:

IF ITEMS ON ABOVE TABLE SHOW DEFICIENCIES OR REJECTIONS PLANS WILL REQUIRE RESUBMITTAL.

ACCEPTANCE OF PRELIMINARY PLANS WILL NOT BE GRANTED UNTIL ISSUES MARKED ARE RESOLVED.

FINAL PLAN REVIEW:

PRIOR TO STRUCTURE CONSTRUCTION SIGNED FINAL PLANS, SPECIAL PROVISIONS, AND HYDRAULIC CALCULATIONS SHALL BE SUBMITTED FOR FINAL REVIEW. IF ALL ITEMS ARE RESOLVED AND PLANS COMPLY WITH WILL RELEASE STRUCTURE FOR CONSTRUCTION.

STATUS MARKS:

N/A = NOT APPLICABLE

NET = NO EXCEPTION TAKEN

MCN = MAKE CORRECTIONS NOTED

NR = REVISE AND RESUBMIT

A = APPROVED

R = REJECTED

APPENDIX SECTION 3
RAILROAD DOCUMENTS

APPENDIX SECTION 3.1

UPRR DOCUMENTS

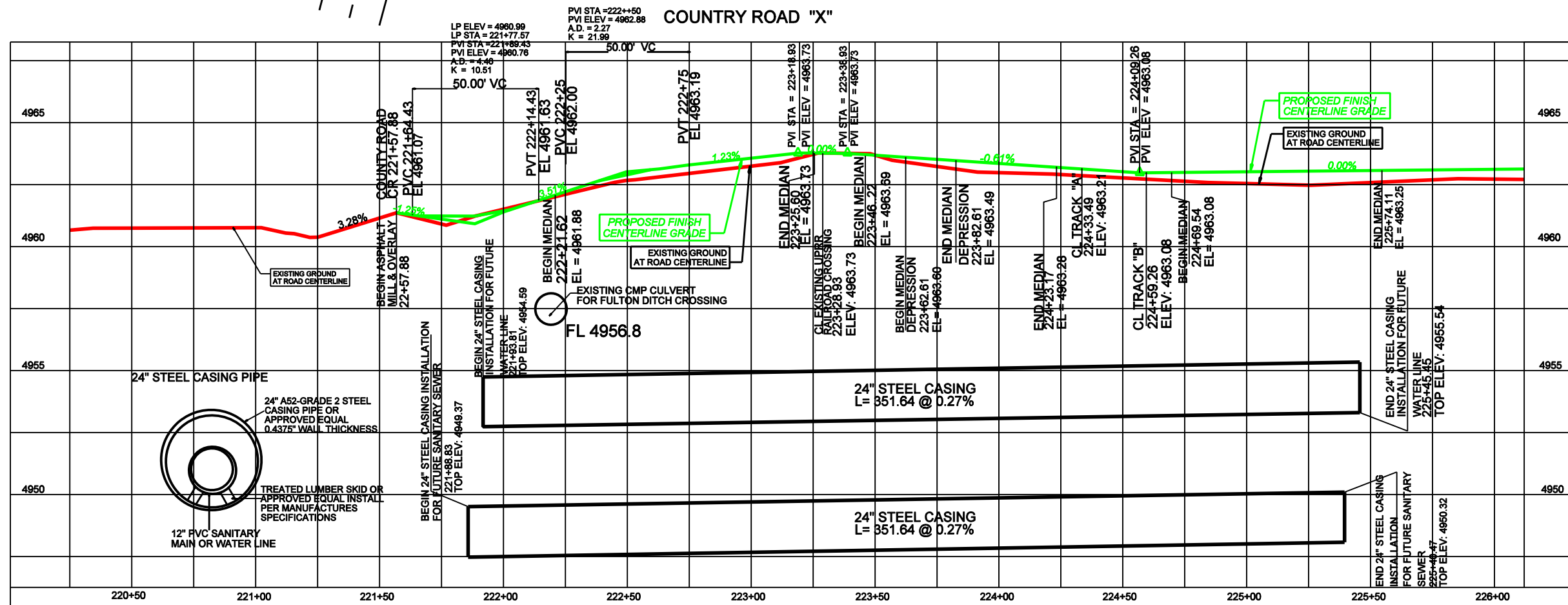
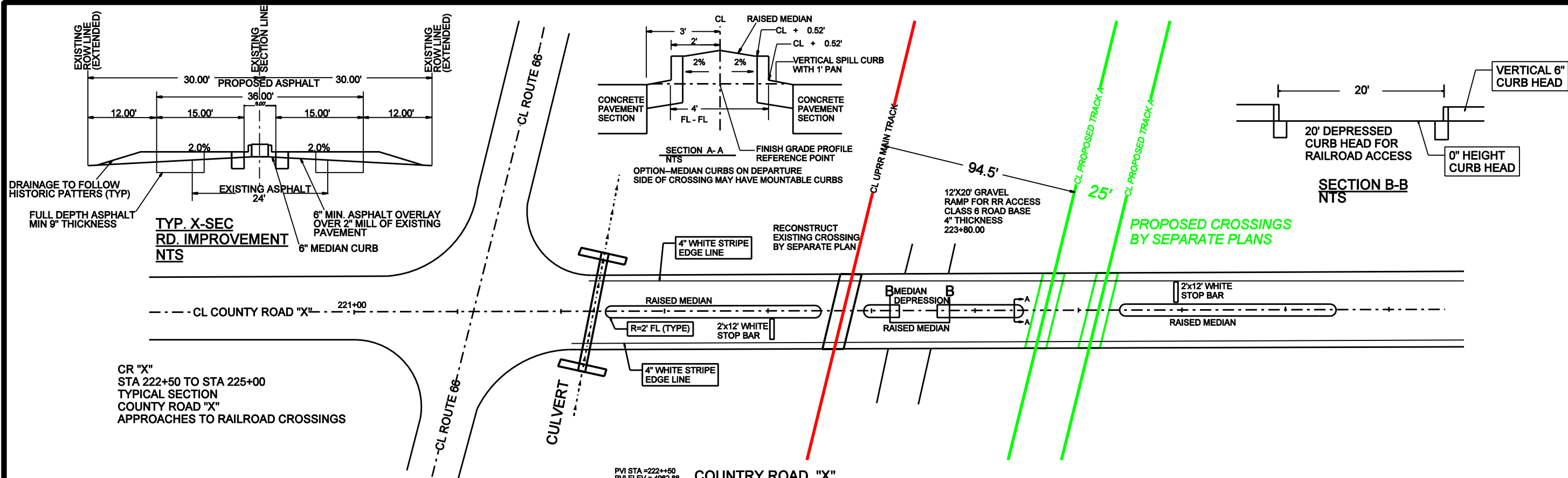

NOTE:
1. ANY OVERHEAD OR UNDERGROUND UTILITIES THAT CROSS RR ROW WILL REQUIRE SEPERATE PERMITS FROM UPRR PRIOR TO INSTALLATION.

2. PROPOSED ROAD PROFILE @ XING TO CONFORM TO CURRENT AASHTO STANDARDS.

3. RAISED MEDIANS WHICH WILL HAVE A FLASHING LIGHT CROSSING SIGNALS INSTALLED MUST BE A MINIMUM OF 8'9" WIDE FROM FACE OF CURB TO FACE OF CURB. RAISED MEDIANS WHICH WILL HAVE A FLASHING LIGHT SIGNAL WITH GATES INSTALLED MUST BE A MINIMUM OF 10' WIDE FROM FACE OF CURB TO FACE OF CURB.

SCALE 1"=50' H
1"=5' V



	DRAWN BY: SNS	UNION PACIFIC RAILROAD Office of Assistant Vice President Engineering Design/Construction
	CHECKED BY: JEP	
	DATE: 10/21/2009	
	SHEET NUMBER: 001 of 001	
LOCATION & DESCRIPTION: COUNTY ROAD IMPROVEMENTS COUNTY ROAD "X" RAILROAD CROSSING		SHEET TITLE: DETAILED PLAN & PROFILE LINE

APPLICATION

(Please allow 30-45 days for crossings and 90-120 days for encroachments)

1. Name of Licensee _____
(Exact Name of the Owner of the Utility)

State of Incorporation _____; if not incorporated, please list entity's legal status

2. Address, email, phone and Fax number of Licensee

Contact Name: _____

Address: _____

Email _____ Phone _____ Fax _____
3. Name, address and phone number of individual to whom agreement is to be mailed
if different than Item 2.

4. Contact information for individual to contact in the event of questions.

Email _____ Phone _____ Fax _____
5. Location of installation –

(City, County and State)

_____ Ft (N), (S), (E), or (W) of the (N), (S), (E), (W) or (center) line of
Section _____; Township _____ (N), (S); Range _____ (E), or (W)

* Texas applications, provide local Survey detail _____
6. Do you have an existing agreement at this location with Union Pacific that is affected
by this request.
() No () Yes, Union Pacific's Audit No. or Folder No. _____
7. Is this installation a crossing _____ or an encroachment _____ or both _____
8. Will this facility serve Union Pacific Railroad? _____ Yes _____ No

UNION PACIFIC RAILROAD
1400 DOUGLAS STREET MS 1690
OMAHA NE 68179

PLACE ARROW INDICATING NORTH
DIRECTION RELATIVE TO CROSSING

FORM DR-0404-A
REV. 5-15-98
www.uprr.com

ENCASED FLAMMABLE PIPELINE CROSSING

NOTE: ALL AVAILABLE DIMENSIONS MUST BE
FILLED IN TO PROCESS THIS APPLICATION.

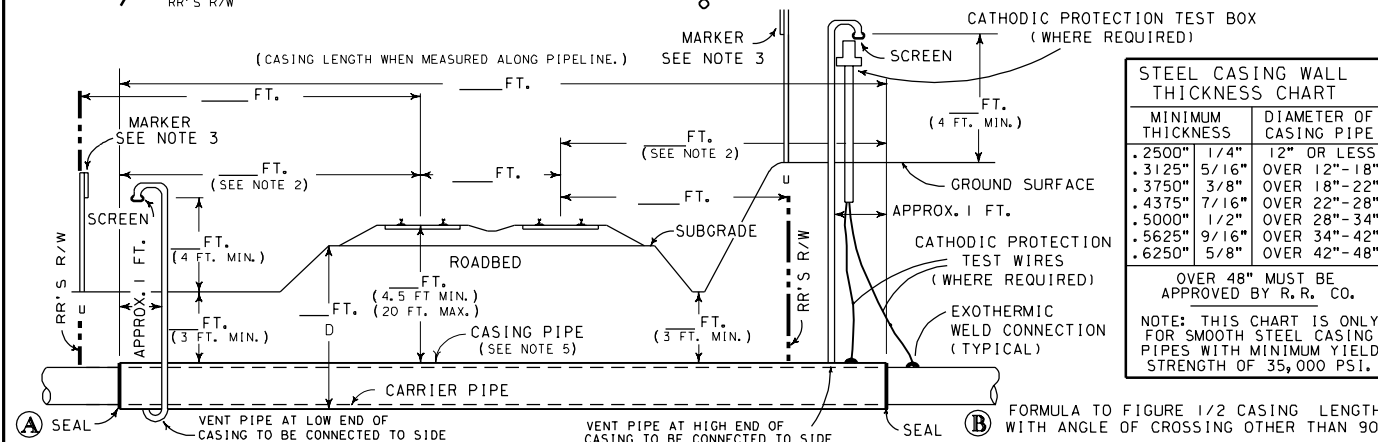
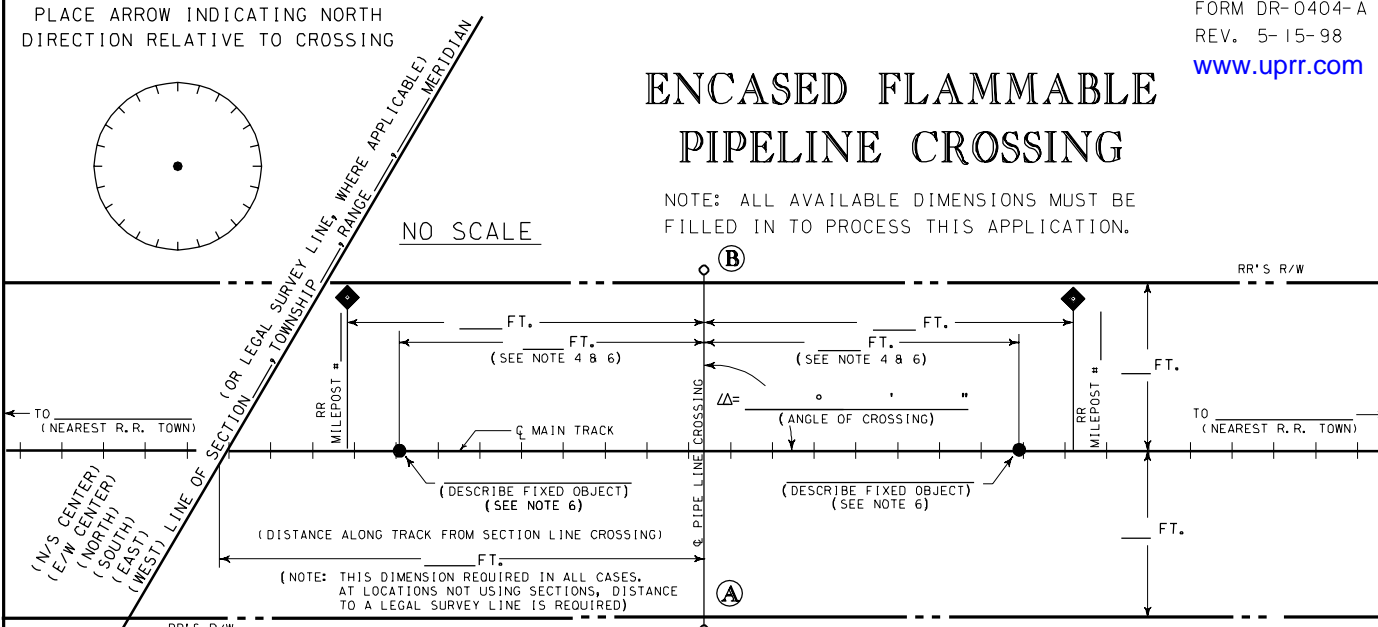

MINIMUM THICKNESS	DIAMETER OF CASING PIPE	
.2500"	1/4"	12" OR LESS
.3125"	5/16"	OVER 12" - 18"
.3750"	3/8"	OVER 18" - 22"
.4375"	7/16"	OVER 22" - 28"
.5000"	1/2"	OVER 28" - 34"
.5625"	9/16"	OVER 34" - 42"
.6250"	5/8"	OVER 42" - 48"

OVER 48" MUST BE APPROVED BY R. R. CO.

NOTE: THIS CHART IS ONLY FOR SMOOTH STEEL CASING PIPES WITH MINIMUM YIELD STRENGTH OF 35,000 PSI.

- NOTES:
- 1) ALL HORIZONTAL DISTANCES TO BE MEASURED AT RIGHT ANGLES FROM \mathcal{C} OF TRACK.
 - 2) CASING TO EXTEND BEYOND THE \mathcal{C} OF TRACK AT RIGHT ANGLES THE GREATER OF $2D + 20$ FT., OR 45 FT., AND BEYOND LIMIT OF RAILROAD RIGHT-OF-WAY IF NECESSARY TO PROVIDE PROPER LENGTH OUTSIDE OF TRACK.
 - 3) MARKER TO INDICATE LOCATION OF PIPELINE AT RIGHT-OF-WAY LINE. IN ADDITION, MARKERS SHALL BE INSTALLED AT MINIMUM 500 FT. INTERVALS ALONG PIPELINE ENCROACHMENTS AND AT LOCATIONS OF MAJOR CHANGE OF DIRECTION.
 - 4) MINIMUM OF 50' FROM THE END OF ANY RAILROAD BRIDGE, \mathcal{C} OF ANY CULVERT, OR FROM ANY SWITCHING AREA.
 - 5) SIGNAL REPRESENTATIVE MUST BE PRESENT DURING INSTALLATION IF RAILROAD SIGNALS ARE IN THE VICINITY OF CROSSING.
 - 6) ALLOWABLE FIXED OBJECTS INCLUDE: BACKWALLS OF BRIDGES; \mathcal{C} OF ROAD CROSSINGS & OVERHEAD VIADUCTS (GIVE ROAD NAME), OR CULVERTS.
 - 7) CASING AND CARRIER PIPE MUST BE PLACED A MINIMUM OF 2 FEET BELOW THE EXISTING FIBER OPTIC CABLE. ANY EXCAVATION REQUIRED WITHIN 5 FEET OF THE EXISTING FIBER OPTIC CABLE MUST BE HAND DUG.

A) IS PIPELINE CROSSING WITHIN DEDICATED STREET? YES; NO;

B) IF YES, NAME OF STREET _____

D) DISTRIBUTION LINE _____ OR TRANSMISSION LINE _____

C) CARRIER PIPE:
COMMODITY TO BE CONVEYED _____
OPERATING PRESSURE _____ PSI
WALL THICKNESS _____; DIAMETER _____; MATERIAL _____;

E) CASING PIPE:
WALL THICKNESS _____; DIAMETER _____; MATERIAL _____;
NOTE: CASING MUST HAVE 2" CLEARANCE BETWEEN GREATEST OUTSIDE DIAMETER OF CARRIER PIPE AND INTERIOR DIAMETER OF CASING PIPE. WHEN FURNISHING DIMENSIONS, GIVE OUTSIDE OF CARRIER PIPE AND INSIDE OF CASING PIPE.

F) METHOD OF INSTALLING CASING PIPE UNDER TRACK(S):
_____ DRY BORE AND JACK (WET BORE NOT PERMITTED);
_____ TUNNEL; OTHER _____

G) WILL CONSTRUCTION BE BY AN OUTSIDE CONTRACTOR? YES; NO;

H) DISTANCE FROM CENTER LINE OF TRACK TO NEAR FACE OF BORING AND JACKING PITS WHEN MEASURED AT RIGHT ANGLES TO TRACK _____ (30' MIN.)

I) APPLICANT HAS CONTACTED 1-800-336-9193, U. P. COMMUNICATION DEPARTMENT, AND HAS DETERMINED FIBER OPTIC CABLE _____ DOES; _____ DOES NOT; EXIST IN VICINITY OF WORK TO BE PERFORMED. TICKET NO. _____

EXHIBIT "A"
(FOR RAILROAD USE ONLY)

UNION PACIFIC RAILROAD CO.

(SUBDIVISION) _____

M. P. _____ E. S. _____

ENCASED _____ CROSSING AT _____

(NEAREST CITY) _____ (COUNTY) _____ (STATE) _____

(APPLICANT) _____

RR FILE NO. _____ DATE _____

WARNING

IN ALL OCCASIONS, U. P. COMMUNICATIONS DEPARTMENT MUST BE CONTACTED IN ADVANCE OF ANY WORK TO DETERMINE EXISTENCE AND LOCATION OF FIBER OPTIC CABLE.
PHONE : 1-800-336-9193

PLACE ARROW INDICATING NORTH
DIRECTION RELATIVE TO CROSSING

UNCASED GAS TRANSMISSION PIPELINE CROSSING

NO SCALE

NOTE: ALL AVAILABLE DIMENSIONS MUST BE
FILLED IN TO PROCESS THIS APPLICATION.

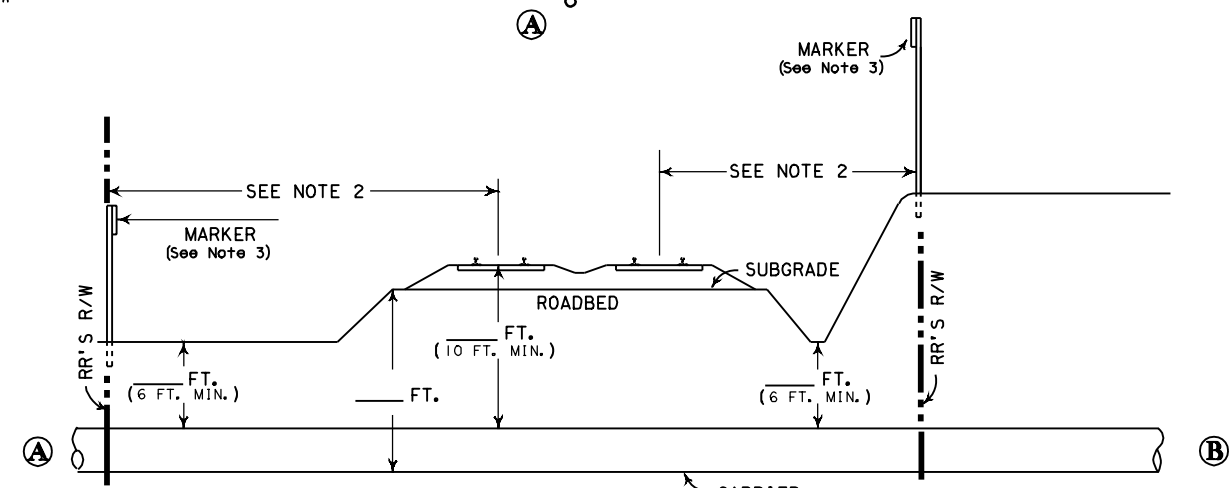
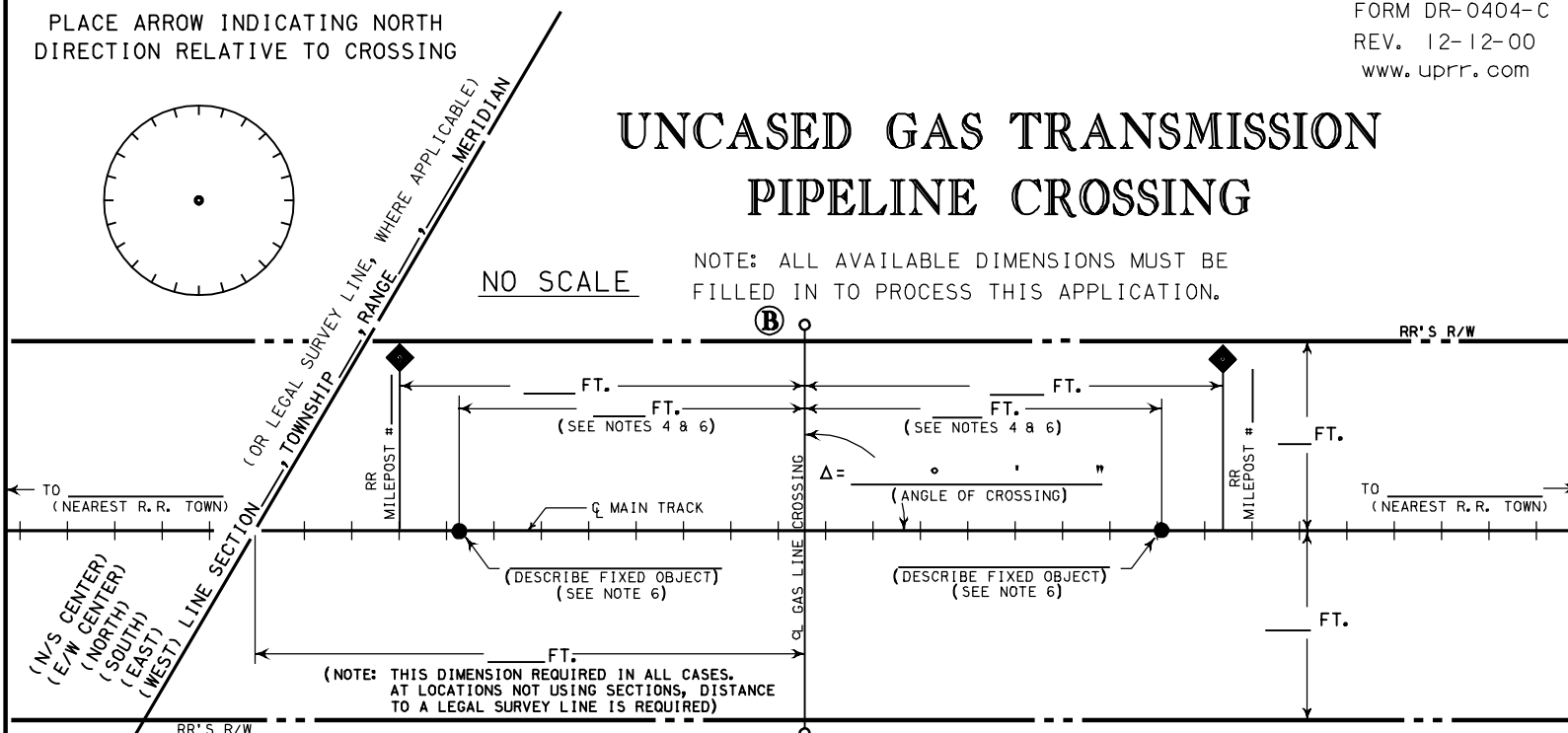

- NOTES :
- 1) ALL HORIZONTAL DISTANCES TO BE MEASURED AT RIGHT ANGLES FROM ϕ OF TRACK.
 - 2) REQUISITES FOR CARRIER LINE PIPE SHALL APPLY FROM RIGHT-OF-WAY TO RIGHT-OF-WAY.
 - 3) MARKER TO INDICATE LOCATION OF PIPELINE AT RIGHT-OF-WAY LINE. IN ADDITION, MARKERS SHALL BE INSTALLED AT MINIMUM 500 FT. INTERVALS ALONG PIPELINE ENCROACHMENTS AND AT LOCATIONS OF MAJOR CHANGE OF DIRECTION.
 - 4) MINIMUM OF 50' FROM THE END OF ANY RAILROAD BRIDGE, ϕ OF ANY CULVERT, OR FROM ANY SWITCHING AREA.
 - 5) SIGNAL REPRESENTATIVE MUST BE PRESENT DURING INSTALLATION IF RAILROAD SIGNALS ARE IN THE VICINITY OF CROSSING.
 - 6) ALLOWABLE FIXED OBJECTS INCLUDE: BACKWALLS OF BRIDGES; ϕ OF ROAD CROSSINGS & OVERHEAD VIADUCTS (GIVE ROAD NAME), OR CULVERTS.
 - 7) CASING AND CARRIER PIPE MUST BE PLACED A MINIMUM OF 2 FEET BELOW THE EXISTING FIBER OPTIC CABLE. ANY EXCAVATION REQUIRED WITHIN 5 FEET OF THE EXISTING FIBER OPTIC CABLE MUST BE HAND DUG.
 - 8) CARRIER PIPE MUST BE OF STEEL CONSTRUCTION WITH CATHODIC PROTECTION PROVIDED

A) IS PIPELINE CROSSING WITHIN DEDICATED STREET? YES; NO;

B) IF YES, NAME OF STREET _____

C) CARRIER PIPE :

COMMODITY TO BE CONVEYED (NO LIQUIDS ALLOWED) _____

OPERATING PRESSURE _____ PSI

WALL THICKNESS _____; DIAMETER _____;

D) METHOD OF INSTALLING CARRIER PIPE UNDER TRACK(S):

_____ DRY BORE AND JACK (WET BORE NOT PERMITTED);

_____ TUNNEL; OTHER _____

E) DISTANCE FROM CENTER LINE OF TRACK TO NEAR FACE OF BORING AND JACKING PITS WHEN MEASURED AT RIGHT ANGLES TO TRACK _____ (30' MIN.)

F) WILL CONSTRUCTION BE BY AN OUTSIDE CONTRACTOR? YES; NO;

G) APPLICANT HAS CONTACTED 1-800-336-9193, U. P. COMMUNICATION DEPARTMENT, AND HAS DETERMINED FIBER OPTIC CABLE _____ DOES; _____ DOES NOT; EXIST IN VICINITY OF WORK TO BE PERFORMED. TICKET NO. _____

EXHIBIT "A"
(FOR RAILROAD USE ONLY - DO NOT WRITE IN THIS BOX)

UNION PACIFIC RAILROAD CO.

(SUBDIVISION)

M. P. _____ E. S. _____

UNCASED GAS PIPELINE AT

(NEAREST RR STATION) (COUNTY) (STATE)

FOR _____ (APPLICANT)

RR FILE NO. _____

WARNING

IN ALL OCCASIONS, U. P. COMMUNICATIONS DEPARTMENT MUST BE CONTACTED IN ADVANCE OF ANY WORK TO DETERMINE EXISTENCE AND LOCATION OF FIBER OPTIC CABLE. PHONE : 1-800-336-9193

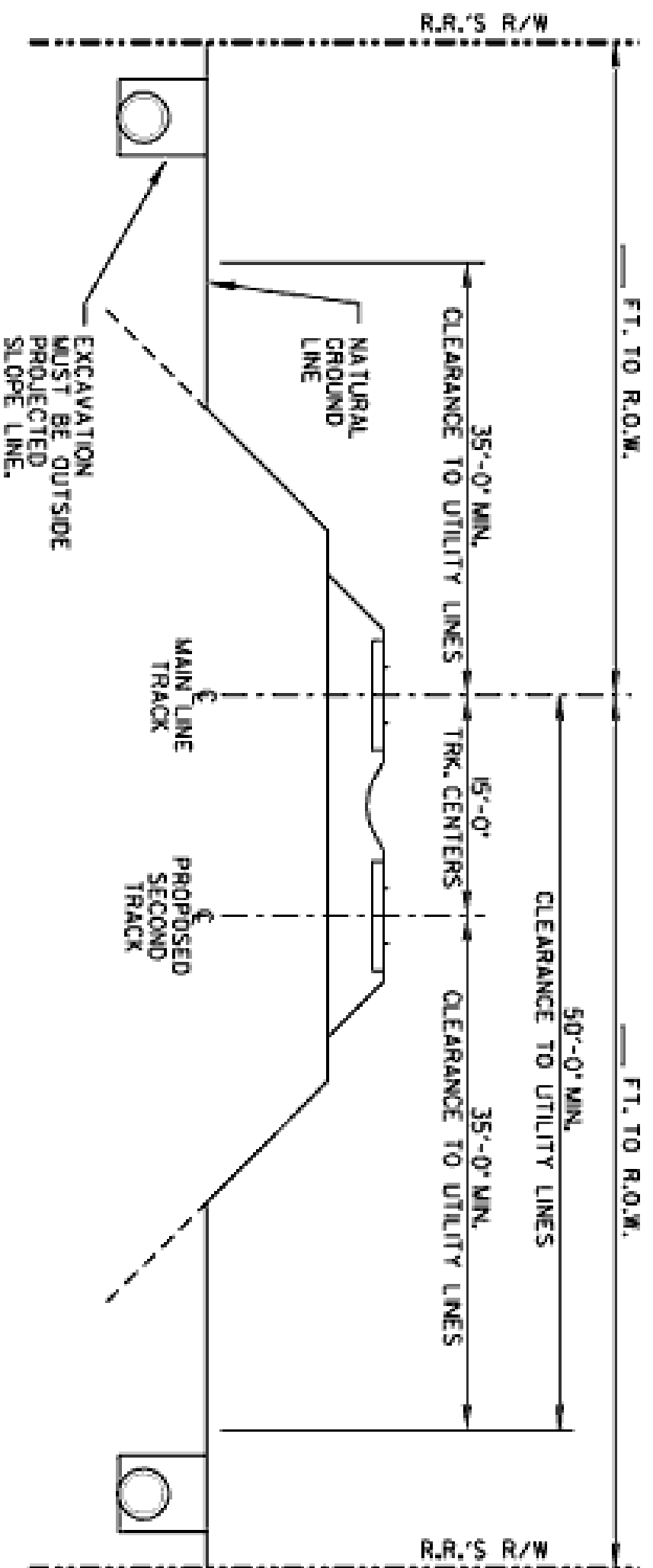

PARALLEL ENCROACHMENTS FOR UTILITY LINES

NO SCALE

- NOTES:
1. IT WILL NOT BE PERMISSIBLE TO ATTACH UTILITY LINES HANDLING GAS OR FLUIDS TO BRIDGES. COMMUNICATION LINES MAY BE ATTACHED WITH THE ATTACHMENT TO THE BRIDGE STRUCTURE APPROVED ON A PER BRIDGE BASIS.
 2. ALL PIPELINES SHALL BE BURIED A MINIMUM OF 5 FEET BELOW NATURAL GROUND.

Road Crossing Checklist

In order for Union Pacific to review your proposed project, you need to provide a Preliminary Engineering Agreement, location map and concept Plan. It is not implied that your project shall be accepted or approved by Union Pacific by executing a Preliminary Engineering Agreement.

The following checklist is meant to assist your agency and Union Pacific in assuring an accurate scope of work and a clear understanding of the agency's project by creating a detailed plan and profile. If you have additional details available that were not included in this checklist, please provide them as an attachment with your Concept Plan. Your Concept Plan should be presented on 11 x 17-inch paper with a scale of 1 inch to 20 feet.

DETAIL	PROVIDED	N/A
Scope of Work detailing work to be done by Agency and/or Railroad		
Show existing and proposed Roadway Right of Way lines		
Show existing Railroad Right of Way		
Degree of angle of roadway intersection at railroad crossing.		
Number & width of roadway lanes		
Number & width of shoulders		
Number & width of sidewalks		
Width of median		
Degree of curvature and profile grade of roadway on railroad right of way		
Existing or proposed super elevation of roadway over on railroad right of way		
Curbing type		
Number, length, width and distance to near rail of medians		
Existing and proposed pavement markings		
Fencing		
Illumination		
Photos of all four quadrants of project location.		
Direction of traffic per lane		
Existing and proposed warning device type and location as selected by highway authority consistent with applicable Federal and State Guidelines and Regulations.		
Distance from near rail to parallel roadway		
Intersection within 200 ft of railroad.		
Traffic signal within 200 ft of a railroad.		
Location of traffic signal on railroad right of way		
Existing and proposed pre-emption type and requested timing		
Existing and proposed utilities locations and types		
Location of existing signboards/billboards		
Traffic type (public, industrial, commercial, agricultural, residential)		
Existing and proposed traffic counts.		
Existing agreements with railroad.		
Deeds, surveys, legal description of property to be accessed by private crossing		



**PERMIT TO BE ON RAILROAD PROPERTY
FOR NONINTRUSIVE CIVIL ENGINEERING SURVEY WORK**

RECITALS:

1. The undersigned party seeking permission to be on Railroad property is hereinafter called "Permittee".
2. Due to the nature of Railroad operations, Railroad property can be a dangerous place for people and/or property. Railroad's safety rules and practices shall be strictly observed and followed at all times while on Railroad property.

WHEREAS, Permittee desires to obtain temporary permission to enter and be on or about the tracks and/or property of the UNION PACIFIC RAILROAD COMPANY (hereinafter called "Railroad"), for the purpose of performing nonintrusive civil engineering survey work, without the use of vehicles and/or machinery on Railroad's property; and

WHEREAS, the Railroad is willing to allow the Permittee temporary permission to be on or about its premises for the purpose aforesaid on the terms and conditions stated herein:

NOW THEREFORE, Railroad grants to Permittee temporary permission to be on or about the tracks and/or property of the Railroad for the purpose above stated, subject to the following conditions:

1. Before exercising any privilege under the permission herein given, Permittee shall contact the Railroad Superintendent's office having jurisdiction over the property involved.
2. Permittee shall become familiar with and strictly observe Railroad's safety rules and all other rules, regulations, or directions of Railroad's Superintendent or his representatives.
3. Permittee shall agree to the terms and conditions of this instrument, and shall so evidence by his execution of same.
4. The above recited permission is granted solely upon the condition that Permittee shall and hereby does agree to indemnify, protect and save harmless, Railroad from any and all loss or damage that Railroad may sustain or become liable for, caused by, resulting from, or by reason of any injury to or death of any persons whomsoever, or destruction of property of any kind to whomsoever belonging, howsoever suffered or caused, regardless of whether caused solely or contributed to in part by the negligence or fault of the Railroad, in or incident to or in connection with the aforesaid work on Railroad's property hereinabove referred to. Public Agencies shall indemnify Railroad as herein described to the extent allowed by law.
5. Upon completion of your work, but in no event later than the last day of the term of this agreement, Permittee will remove all of his tools, equipment, and other property of any kind whatsoever, and restore Railroad's property to substantially the same condition that existed prior to the performance of your work hereunder.
6. This permit may be revoked at any time by the Railroad, but if not revoked shall expire at the end of the last date written below. PLEASE complete the following information and execute in the space marked "By". You should then FAX a copy to 402-233-2022 for execution on behalf of the Railroad Company, after which one copy will be returned to you by fax. You must KEEP your fully-executed copy in your possession at all times while on Railroad property. It MUST be shown on request to any Railroad employee or official.

(Company Name)

(Street Address)

(City, State, Zip)

(Telephone) (Return Fax Number)

(E-mail Address)

By: _____ / _____
(Print Name) (Signature)

Title: _____

Date of Survey: _____ / _____
(30 Day Max)

Location of Survey: _____
(City, State)

UNION PACIFIC RAILROAD COMPANY

BY: _____
Director - Contracts

Real Estate
Union Pacific Railroad Company
STOP 1690
1400 Douglas Street
Omaha NE 68179-1690

Please include map of location (ex:- google, mapsco)

APPENDIX SECTION 3.2

UTA DOCUMENTS

5. Is Proposed Use a (check all that apply): crossing (perpendicular to Tracks)
 encroachment (parallel to Tracks)

Utility Surface
 Other _____ overhead
_____ underground

6. Is Proposed Use within a dedicated street(s)? no
 yes If yes, name of street(s):

7. Additional information pertinent to the Proposed Use:

8. Will construction be by a contractor? yes
 no

By Applicant? yes
 no

If contractor, name of contractor: _____

Address: _____

Representative of contractor to contact in the event of questions.

(Name) (Phone #) (Fax #)

9. Describe in detail the method and manner of installation on UTA Property:

Submit application with administration fee and pertinent drawings to:

UTAH TRANSIT AUTHORITY
Attn: Property Manager
669 West 200 South
Salt Lake City, UT 84101

UTA

Cat. I: Utility Crossing / Minor Property Use License Procedure

This procedure is intended for the individual or business entity that needs to install and maintain facilities (utility lines, minor general property uses, etc.) across, over, or under UTA property or track corridors. Upon granting of license, Licensee should be prepared to pay a onetime real estate usage charge for its use and occupation of UTA property.

1. The review-approval process for the License will begin once UTA has received from applicant all of the following items:
 - a. A completed Category I License Application. (Applications may be obtained via E-mail, fax or mail, by contacting UTA property administrators at (801) 237-1916 or 1995.)
 - b. A \$1000 administrative fee made out to Utah Transit Authority.
 - c. A written summary of the License desired.
 - d. An area map identifying the portion of the property / corridor to be encumbered.
 - e. An engineered drawing (Plan and Profile) that includes the following:
 1. The location and dimension of the UTA property / corridor.
 2. The location and dimension of any adjacent streets.
 3. The location of the centerline (or footprint) of the proposed facility.
 4. The depth of the conduit or other facility. (UTA conduit depth requirements: Steel = 6 feet, PVC = 11 feet)
 5. The type, size and thickness of the conduit and line.
2. Application materials may be mailed or delivered to:

Property Administrator
Utah Transit Authority
669 West 200 South
Salt Lake City, UT 84101

OR

Applicant may request a meeting with UTA property staff to deliver the application materials and introduce or clarify the request.

3. The customary time for UTA staff to review, approve, create and execute a minor property use or right-of-way "crossing" license agreement is approximately 45 days (from the day that an acceptable drawing is received). If this time frame does not meet the applicant's needs, accommodations for expedited processing may be considered and granted for an additional fee of \$2,500.

UTAH TRANSIT AUTHORITY
CAT. II APPLICATION
General Encroachments / Grade Crossings /Trails

A One Time Administration Fee is assessed to cover the cost of engineering and legal review, document preparation, and other costs:

- An advance non-refundable payment of \$ 1000.00 is required with this application.
 - The advance payment will apply to the final Administration Fee.
 - **The amount of the final Administration Fee depends on extent of administrative, engineering and legal review required for this application.**
 - **Upon receipt of application and advance payment, applicant will be informed of the amount of the final Administration Fee**
 - The application will not be processed without this advance payment.
-

1. Name of Applicant: _____
(Name to be shown on document)

Business Address: _____

*Invoicing Address: _____

*Invoicing information needed by Applicant: _____

* Please provide the address to which invoicing for relevant fees or costs should be sent and describe information that is needed on all invoices to assure proper handling (such as file no., street location, type of crossing or encroachment, etc.)

NOTE: The corporate name of a company should be exactly as stated in its articles of incorporation.

Applicant is an:

- | | |
|--|------------------------------|
| <input type="checkbox"/> Corporation | What state? _____ Type _____ |
| <input type="checkbox"/> Limited Liability Company | What state? _____ |
| <input type="checkbox"/> Partnership | What state? _____ |
| <input type="checkbox"/> Individual / Proprietorship | |
| <input type="checkbox"/> Other | Explain _____ |

2. Name and title of person who will execute the License Agreement for the Applicant.

(Name) (Title)

3. Contact person regarding preparation of the License Agreement.

Name: _____ Title _____
Address: _____
Phone: _____
Fax: _____

4. When do you propose to begin construction on UTA Property / Right-of-Way.

5. Is Proposed Use a (check all that apply):
- | | |
|---|--|
| <input type="checkbox"/> Crossing (perpendicular to Tracks) | <input type="checkbox"/> Encroachment (parallel to Tracks) |
| <input type="checkbox"/> Utility | <input type="checkbox"/> Surface |
| <input type="checkbox"/> Roadway | <input type="checkbox"/> Overhead |
| <input type="checkbox"/> Trail | <input type="checkbox"/> Underground |
| <input type="checkbox"/> Other _____ | |

6. Is Proposed Use within a dedicated street(s)? No Yes

If yes, name of street(s):

7. Additional information pertinent to the Proposed Use:

8. Will construction be by a contractor? yes no

By Applicant? yes no

If contractor, name of contractor: _____

Address: _____

Representative of contractor to contact in the event of questions.

(Name) (Phone #) (Fax #)

9. Describe in detail the method and manner of installation on UTA Property:

Please attach any additional information if the allotted space is inadequate.

Submit application with administration fee and pertinent drawings to:

UTAH TRANSIT AUTHORITY
Attn: Property Manager
669 West 200 South
Salt Lake City, UT 84101

UTA

Cat. II: General Encroachment / Grade Crossing License Procedure

This procedure is intended for the individual or business entity that needs to install and maintain facilities or structures (utility lines, buildings, road crossings, etc.) across, over, or under UTA track corridors. Upon granting of license, Licensee should be prepared to pay a onetime real estate usage charge for its use and occupation of UTA property.

1. The review-approval process for the License will begin once UTA has received from applicant all of the following items:
 - a. A completed Category II License Application (Applications may be obtained via E-mail, fax or mail, by contacting UTA property administrators at (801) 237-1917.)
 - b. A \$1,000 deposit towards the administrative fee. Make check payable to Utah Transit Authority.
 - c. Two (2) copies of the following:
 1. A written summary of the License desired.
 2. An area map identifying the portion of the property / corridor to be encumbered.
 3. An engineered drawing (Plan and Profile) that includes the following:
 - a. The location and dimension of the UTA property / corridor.
 - b. The location and dimension of any adjacent streets.
 - c. The location of the centerline (or footprint) of the proposed facility.
 - d. The depth of the conduit or other facility. The type, size and thickness of the conduit and line.
2. Application materials may be mailed or delivered to:

Property Manager
Utah Transit Authority
669 West 200 South
Salt Lake City, UT 84101

OR

Applicant may request a meeting with UTA property staff to deliver the application materials and introduce or clarify the request.

3. The customary time for UTA staff to review, approve, create and execute a Cat. II general property use or right-of-way "encroachment" license agreement is at least 90 days (from the day that an acceptable drawing is received). Cat. II requests must be reviewed and approved by UTA Development Review Committee (DRC), which meets monthly. Complex issues may require more than one review by the DRC.

UTAH TRANSIT AUTHORITY

Right of Entry Agreement Application

- UTA approved drawings and necessary insurance requirements must be submitted prior to the final execution of the Right of Entry Agreement
- All persons doing work on an active railway must have rail safety training
- If work is being done on a shared Right of Way, a Right of Entry must be granted by all owners of the Right of Way.

1. Name of Applicant: _____
(Company Name to be shown on document)

Business Address: _____

NOTE: The corporate name of a company should be exactly as stated in its articles of incorporation.

Applicant is an:

- Corporation What state? _____
- Limited Liability Company What state? _____
- Partnership What state? _____
- Individual / Proprietorship
- Other Explain _____

2. Name and title of person who will execute the Right of Entry Agreement for the Applicant.

Name: _____
Title: _____

3. Contact person regarding preparation of the Right of Entry Agreement.

Name: _____ Title _____
Address: _____
Phone: _____
Fax: _____
Email: _____

4. Who has contracted this work to be done (Licensee)? _____

5. Nature of work (check all that apply):
- crossing (perpendicular to Tracks)
 - encroachment (parallel to Tracks)
 - Utility
 - Surface
 - Other _____
 - overhead _____
 - underground

6. At what location will this work be done? (The party contracting the work should have this info)
Mile Post? _____ Line? _____ City? _____

Or

Detailed description of the location? _____

7. When do you propose to begin work on UTA Property / Right-of-Way? _____

8. How long will work take to complete? _____

9. Additional information pertinent to the work being done:

Submit application with pertinent drawings to:

UTAH TRANSIT AUTHORITY
Attn: Property Administration
3600 South 700 West
Salt Lake City, Utah 84119

P.O. Box 30810
Salt Lake City, Utah 84130-0810

EXHIBIT "B"
INSURANCE REQUIREMENTS

LICENSEE shall, at its sole cost and expense, procure and maintain during the life of this Agreement the following insurance coverage:

- A. General liability policy providing coverage for death, personal injury and property damage with a combined single limit of at least \$5 million each occurrence or claim and an aggregate limit of at least \$10 million. The policy shall contain broad form contractual liability insurance covering the indemnity obligations assumed by Licensee in the Agreement. Exclusions for railroads (except where the Grade Separated Crossing is in all places more than 50 feet from any railroad tracks, bridges, trestles, roadbeds, terminals, underpasses or crossings), and explosion, collapse and underground hazard shall be removed. Coverage provided on a "claims made" form shall provide for at least a two-year extended reporting and discovery period if (a) the coverage changes from a claims made form to an occurrence form, (b) there is a lapse/cancellation of coverage, or (c) the succeeding claims made policy retroactive date is different for the expiring policy.
- B. Automobile liability insurance providing bodily injury, property damage and uninsured vehicles coverage with a combined single limit of at least \$2 million each occurrence or claim. This insurance shall cover all motor vehicles including hired and non-owned, and mobile equipment if excluded from coverage under the commercial general liability insurance.
- C. Worker's compensation and employer's liability insurance covering Licensee's statutory liability under the laws of the State of Utah. If Licensee is self-insured, evidence of State approval must be provided.
- D. Contractor must maintain Railroad Protective Liability insurance on behalf of UTA as named insured, with a limit of not less than \$2,000,000 per occurrence and an aggregate of \$6,000,000. A binder stating the policy is in place must be submitted to UTA before the work may be commenced and until the original policy is forwarded to UTA.

Licensee's insurance shall be primary with respect to any insurance carried by UTA. Licensee's policy(ies) shall contain a provision that the insurance company will furnish UTA 30 days' advance written notice of any cancellation or lapse, or the effective date of any reduction in the amount or scope of coverage.

The required insurance policy(ies) shall be written by a reputable insurance company with a current AM Best's Insurance Guide Rate of A better, or as may be otherwise be acceptable to UTA. Such insurance company shall be authorized to transact business in the State of Utah.

The fact that insurance is obtained by Licensee shall not be deemed to release or diminish the liability of Licensee including, without limitation, liability under the indemnity provisions of this Agreement. Damages recoverable by UTA shall not be limited by the amount of the required insurance coverage.

APPENDIX SECTION 3.3
FORM B FLAGGING REQUIREMENTS

On Track Safety Roadway Worker Protection

OTS	On Track Safety--prevent death or injury to roadway workers
Roadway Worker	Railway Worker or Contractor to a Railroad
Job Briefing	Everyday before occupying Right of Way
EIC	Employee in Charge
MCT	Minimum Clearance Time: 15 Seconds
POC	Point of Contact
GCOR	General Code of Operating Rules
FRA	Federal Railroad Administration
PPE	Personal Protective Equipment: Hard Hat, Safety Glasses, Proper Footwear, Orange Safety Vest w/Reflective Stripes

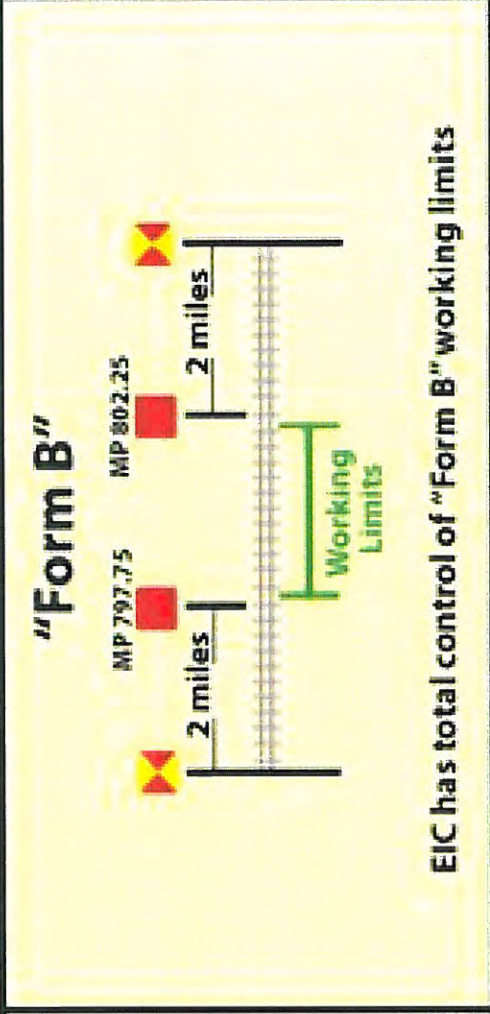
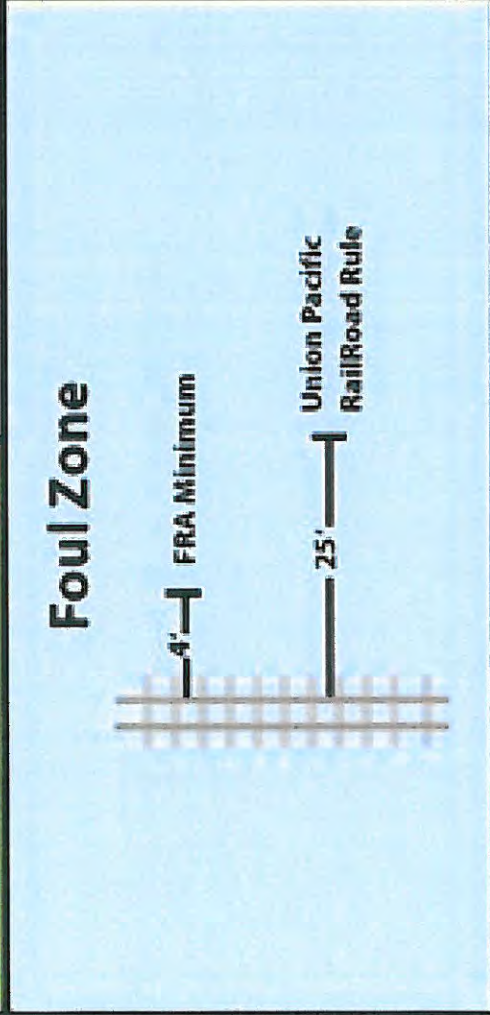

unless they are Stop signals.

5.3.7 Radio Response

When radio communication is used to make movements, crew members must respond to specific instructions given for each movement. In addition:

- Radio communications for backing and shoving movements must specify the direction and distance and must be acknowledged when distance specified is more than four cars.

Movement must stop within half of the distance specified unless additional instructions are received.



5.4 Flags for Temporary Track Conditions

5.4.1 Temporary Restrictions

Track bulletins, track warrants, or general orders may restrict or stop train movements because of track conditions, structures, men, or equipment working. Yellow flags will be used for temporary speed restrictions. Yellow-red flags will be used when a train may be required to stop.

5.4.2 Display of Yellow Flag

A. Restriction Specified in Writing

Two Miles Ahead of Restricted Area. Yellow flags warn trains to restrict movement because of track conditions or structures. To make sure train movement is restricted at the right location, employees must display a yellow flag 2 miles before the restricted area



Less than Two Miles Ahead of Restricted Area. When the restricted area is close to a terminal, junction, or another area, employees will display the yellow flag less than 2 miles before the restricted area. This information will also be included in the track bulletin, track warrant, or general order.

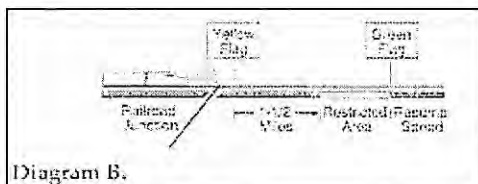

Once the Train Reaches the Restricted Area. The speed specified by track warrant, track bulletin, or general order must not be exceeded until the rear of the train clears the restricted area.

B. Restriction Is Not Specified in Writing

When a yellow flag is displayed and the restriction is not specified by a track bulletin, track warrant, or general order, once the train is 2 miles beyond the yellow flag, crew members

must:

1. Continue moving the train but at a speed not exceeding 10 MPH.
 2. Resume speed only after the rear of the train has:
 - a. Passed a green flag.
- or
- b. Traveled 4 miles beyond the yellow flag and the train dispatcher has verified that no track bulletin or track warrant is in effect specifying a temporary speed restriction at that location.



5.4.3 Display of Yellow-Red Flag

A. Restriction Specified in Writing

Two Miles Ahead of Restricted Area. Yellow-red flags warn a train to be prepared to stop because of men or equipment. To make sure the train is prepared to Stop at the right location, employees must display a yellow-red flag 2 miles before the restricted area.

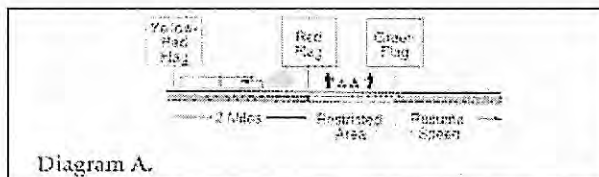

Less Than Two Miles Ahead of Restricted

Area. When the restricted area is close to a terminal, junction, or another area, employees will display the yellow-red flag less than 2 miles before the restricted area. This information will also be included in the track bulletin, track warrant, or general order.

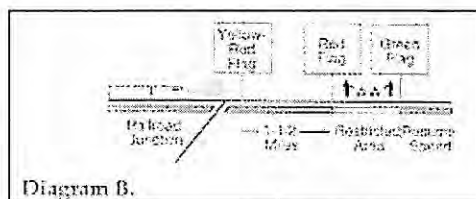

B. Restriction Is Not Specified in Writing

When a yellow-red flag is displayed and the restriction is not specified by a track bulletin, track warrant, or general order, crew members must be prepared to stop short of a red flag 2 miles beyond the yellow-red flag. If a red flag is displayed, proceed as outlined in Rule 5.4.7 (Display of Red Flag or Red Light). If no red flag is displayed:

1. Move at restricted speed.
2. Increase speed only after:
 - a. A crew member has received permission from the employee in charge.
 - b. The rear of the train has passed a green flag.

or

c. The rear of the train has traveled 4 miles beyond the yellow-red flag, and the train dispatcher has verified that no track bulletin or track warrant protecting men or equipment is in effect at that location.

5.4.4 Authorized Protection by Yellow or Yellow-Red Flag

On subdivisions where maximum speed does not exceed 40 MPH, and it is authorized by special instructions, yellow or yellow-red flags may be displayed without the use of track bulletins, track warrants, or flagmen. Yellow or yellow-red flags must be displayed 2 miles before the restricted area. Protection will begin at a point 2 miles beyond the yellow or yellow-red flag and continue for 2 more miles, as outlined in Rule 5.4.2 (Display of Yellow Flag) and Rule 5.4.3 (Display of Yellow-Red Flag).

Note: Crew members do not need to receive verification from the train dispatcher when this rule is in effect.

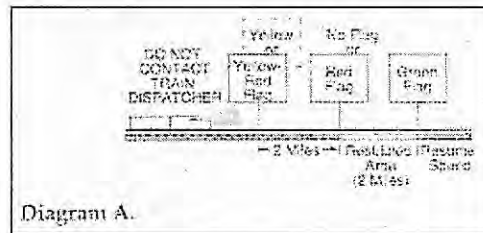

5.4.5 Display of Green Flag

A green flag indicates the end of a restricted area. If a series of locations require reduced speeds or protection for men or equipment, the green flags could overlap yellow or yellow-red flags. When this is the case, employees must:

- Place a yellow or yellow-red flag for each restricted area.
- Place a green flag only at the end of the last restricted area.

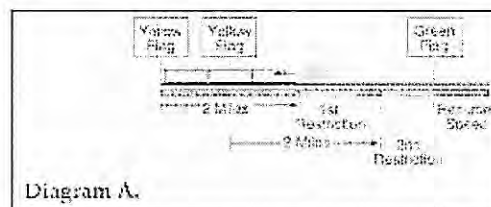

5.4.6 Display of Flags Within Current of Traffic

A. Yellow and Green Flags

Flags for temporary speed restrictions will only be placed for trains moving with the current of traffic.

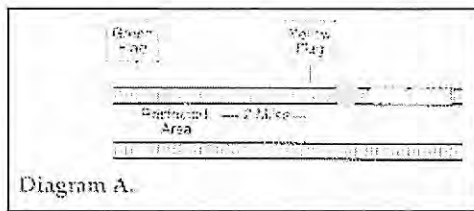
**B. Yellow-Red and Green Flags**

Flags protecting men or equipment must be placed in both directions on each track affected.

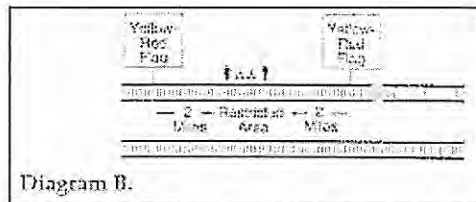

5.4.7 Display of Red Flag or Red Light

A red flag or red light is displayed where trains must stop. When approaching a red flag or red light, the train must stop short of the red flag or red light and not proceed unless the employee in charge gives verbal permission. If permission to proceed is received before the train stops, the train may pass the red flag or red light without stopping.

If track bulletin Form B is not in effect, permission must include speed and distance. This speed must not be exceeded until the rear of the train has passed the specified distance from the red flag or red light, unless otherwise instructed by the employee in charge.

Displayed Between Rails. When a red flag or red light is displayed between the rails of a track other than a main track or controlled siding, the train must stop and not proceed until the flag or light has been removed by an employee of the class that placed it.

5.4.8 Flag Location

Flags will be displayed only on the track affected. However, when yellow, yellow-red, or red flags or red lights are used for protection without a flagman, track bulletin, track warrant, or general order, these flags must be placed to protect all possible access to the restricted area.

Flags must be displayed to the right of the track as viewed from an approaching train, except red flags or red lights may be displayed between the rails as outlined in Rule 5.4.7 (Display of Red Flag or Red Light). Flags will be placed in this manner unless otherwise specified by track bulletin, track warrant, special instructions, or general order.

When flags are displayed beyond the first rail of an adjacent track, the flags will not apply to the track on which the train is moving.

5.5 Permanent Speed Signs

Permanent speed restriction signs will be placed in advance of permanent speed restrictions. Numbers on the face of these signs indicate the highest speed permitted over the limits of the restriction.

Two Sets of Numbers

When two sets of numbers are shown, the greater number governs trains consisting entirely of passenger equipment. The lesser number governs all other trains.

Resume Speed Signs

A permanent resume speed sign or a speed sign showing a higher speed will be placed at the end of each restriction.

Crew members must not exceed the speed shown on each permanent speed restriction sign until the rear of the train:

- Has passed a permanent resume speed sign or a sign showing a higher speed.
- or
- Has cleared the limits of the restriction.



5.6 Unattended Fusee

If a train approaches an unattended fusee burning on or near its track, the train must stop before passing the fusee, if consistent with good train handling.



A train moving at restricted speed must stop before passing the fusee.



After the fusee burns out, or after 10 minutes if the fusee is not visible, the train must proceed at restricted speed until the head end is 1 mile beyond the fusee.

If the unattended burning fusee is beyond the first rail of an adjacent track, the fusee does not apply to the track on which the train is moving.

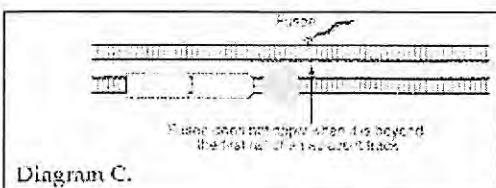

Do not place fusees where they may cause fires.

5.7 Torpedoes

If one or more torpedoes explode, the train must slow to restricted speed immediately and remain at this speed until the head end is 2 miles beyond where the torpedoes exploded.

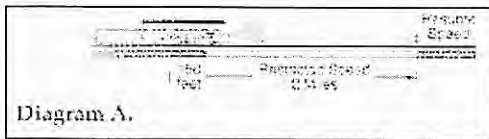

When placing torpedoes, two must be placed not less than 150 feet apart on each rail. They must not be placed near station buildings, crossings, or on other than main tracks or sidings.

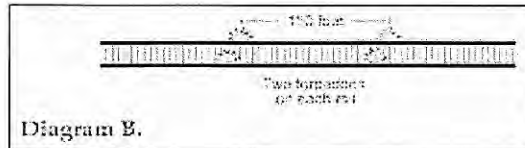

5.8 Bell and Whistle Signals

5.8.1 Ringing Engine Bell

Ring the engine bell under any of the following conditions:

- Before moving, except when making momentary stop and start switching movements.
- As a warning signal anytime it is necessary.
- When approaching public crossings at grade with the engine in front, as follows:
 - If distance permits, ringing must begin at least 1/4 mile before the public crossing and continue until the crossing is occupied.
 - or
 - If distance does not permit, ringing must begin soon enough before the crossing to provide a warning and continue until the crossing is occupied,

5.8.2 Sounding Whistle

When weather conditions impair visibility, sound the whistle frequently.

If the whistle fails, ring the bell continuously while moving.

When other employees are working in the immediate area, sound the required whistle signal before moving.

The radio may be used in place of whistle signals, except signals (1) and (1 1). See following chart.

The required whistle signals are illustrated by "o" for short sounds and "-" for longer sounds:

Indication	Sound
------------	-------

APPENDIX SECTION 3.4
RAILROAD COST SHARING TEMPLATE

Optional Railroad Share of Cost

1. RAILROAD TO SHARE IN PROJECT COST

As set forth in 23 Code of Federal Regulations, 646.210(b)(3), **Railroad** acknowledges that Work described herein results in the elimination of an existing grade crossing at which active warning devices are in place or ordered to be installed by the State regulatory agency therefore, **Railroad** is required to share in the project cost. Said cost has be determined in accordance with the provisions of § 646.210(c), as shown in the attached "**Exhibit F**", attached hereto and thereby made a part hereof.

AND

11. ESTIMATE OF COST

Add the following:

In accordance with **23 CFR 464.210(b)(3)**, the **Railroad's** share of the cost for the project has been determined to be \$_____, as shown in the attached "**Exhibit F**".

TOTAL LUMP SUM COST TO THE RAILROAD IS \$_____

Note: Upon completion of the project, **UDOT** will submit a bill to the **Railroad** in the above referenced amount. **Railroad** will reimburse **UDOT** within sixty (60) days of **Railroad's** receipt of billing from **UDOT**.

APPENDIX SECTION 4

MAPS

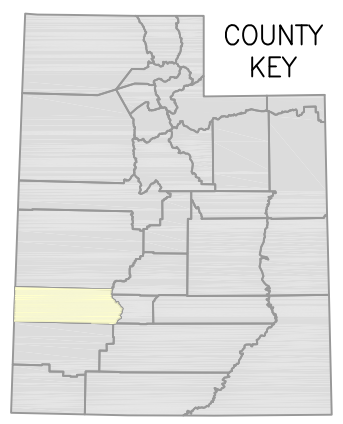
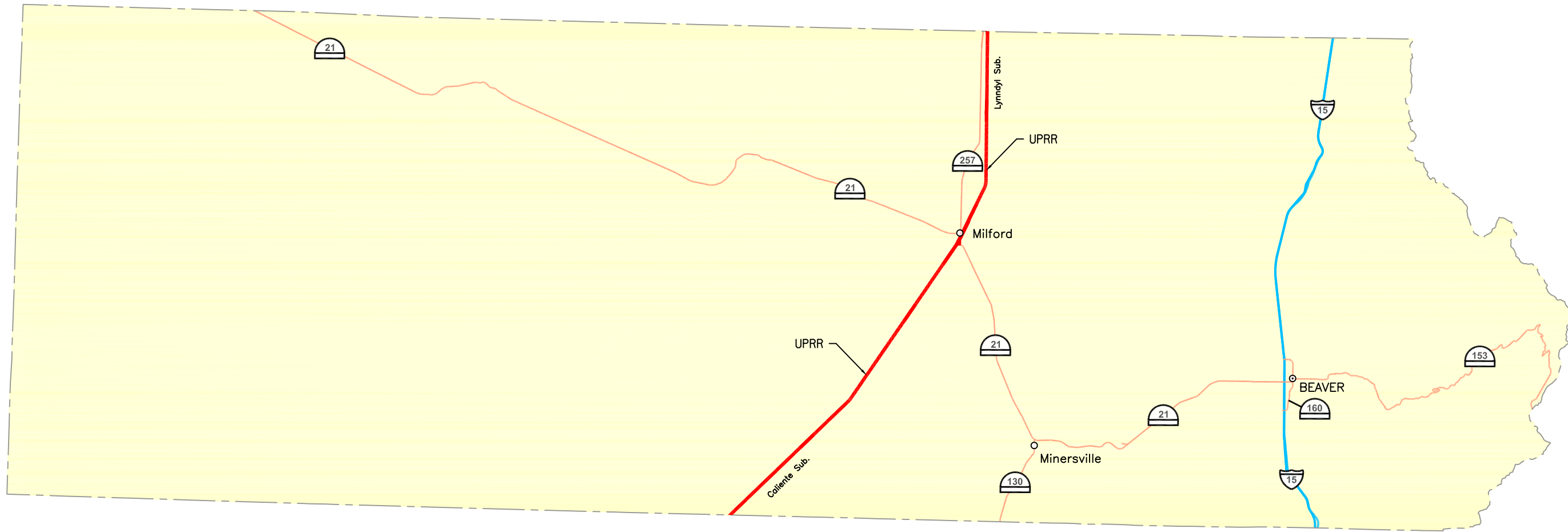

**BEAVER COUNTY
RAILROAD & HIGHWAY
LOCATION MAP**

LEGEND

	INTERSTATE
	U.S. HIGHWAY
	STATE HIGHWAY
	UNION PACIFIC RAILROAD
ABCD	TRACK OWNER
-ABCD	OPERATING RIGHTS

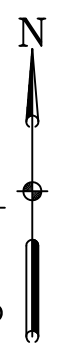
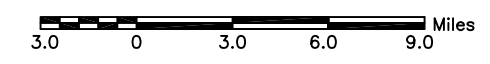

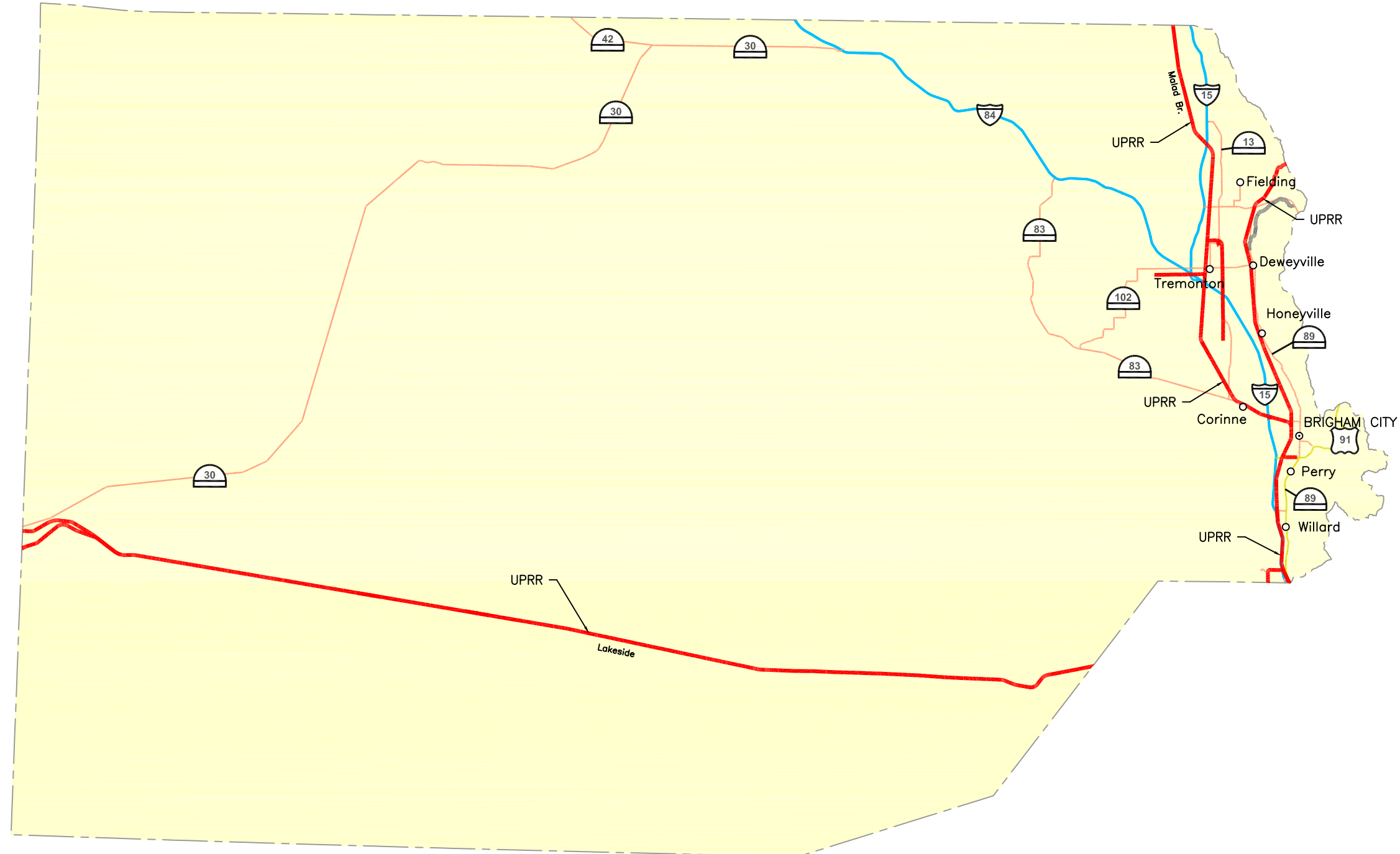
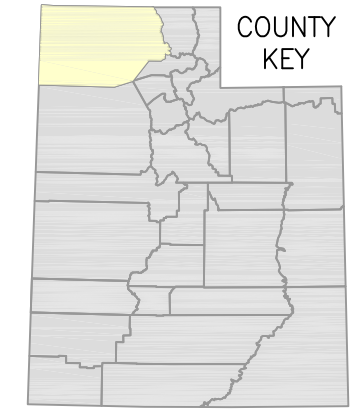

**BOX ELDER COUNTY
RAILROAD & HIGHWAY
LOCATION MAP**

LEGEND

	INTERSTATE
	U.S. HIGHWAY
	STATE HIGHWAY
	UNION PACIFIC RAILROAD
ABCD	TRACK OWNER
-ABCD	OPERATING RIGHTS

4.5 0 4.5 9.0 13.5 Miles

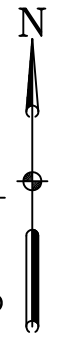

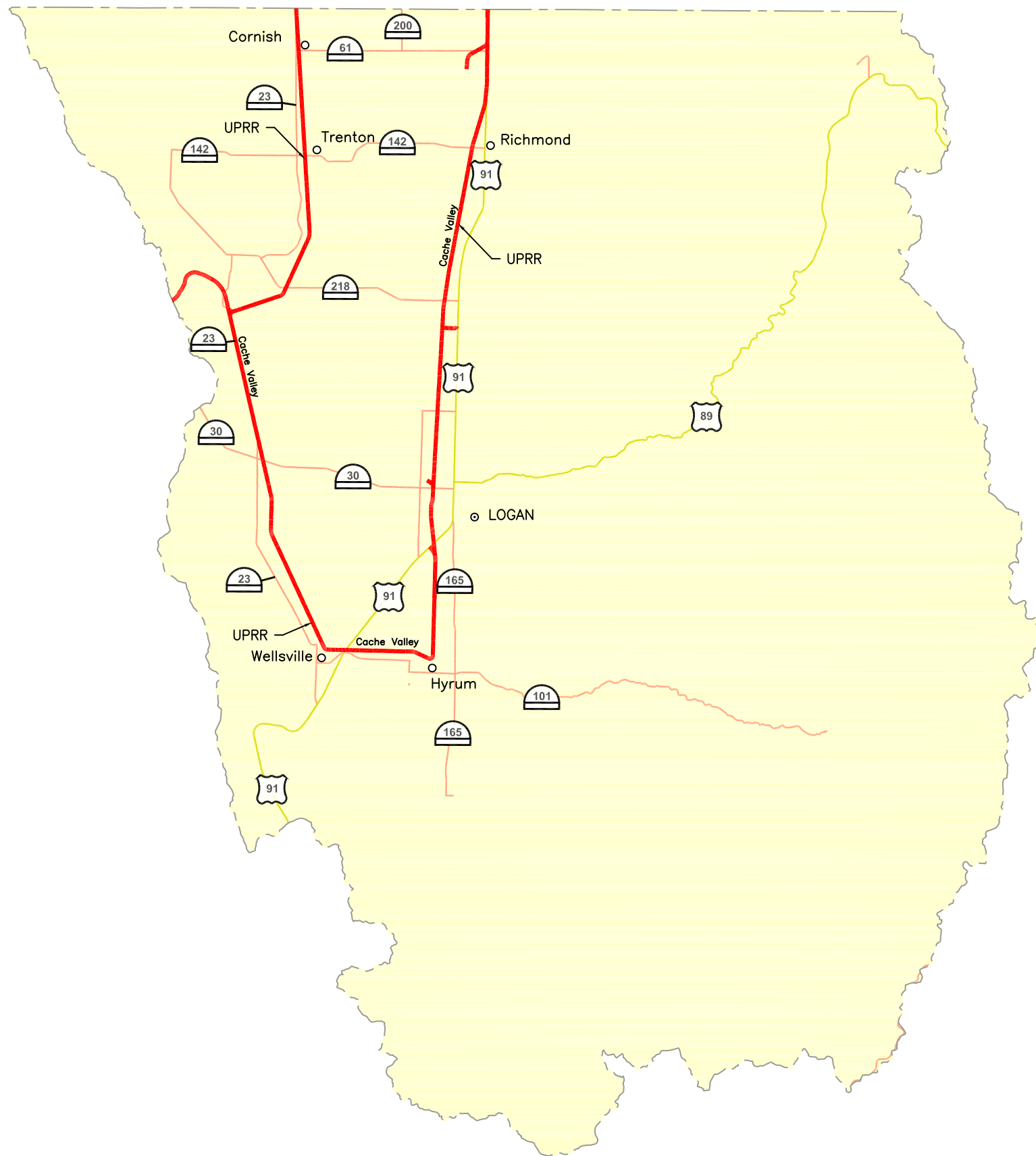

CACHE COUNTY
RAILROAD & HIGHWAY
LOCATION MAP

LEGEND

- INTERSTATE
- U.S. HIGHWAY
- STATE HIGHWAY
- UNION PACIFIC RAILROAD
- ABCD TRACK OWNER
- ABCD OPERATING RIGHTS

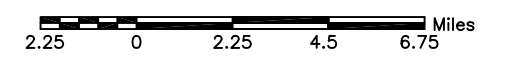
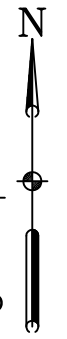

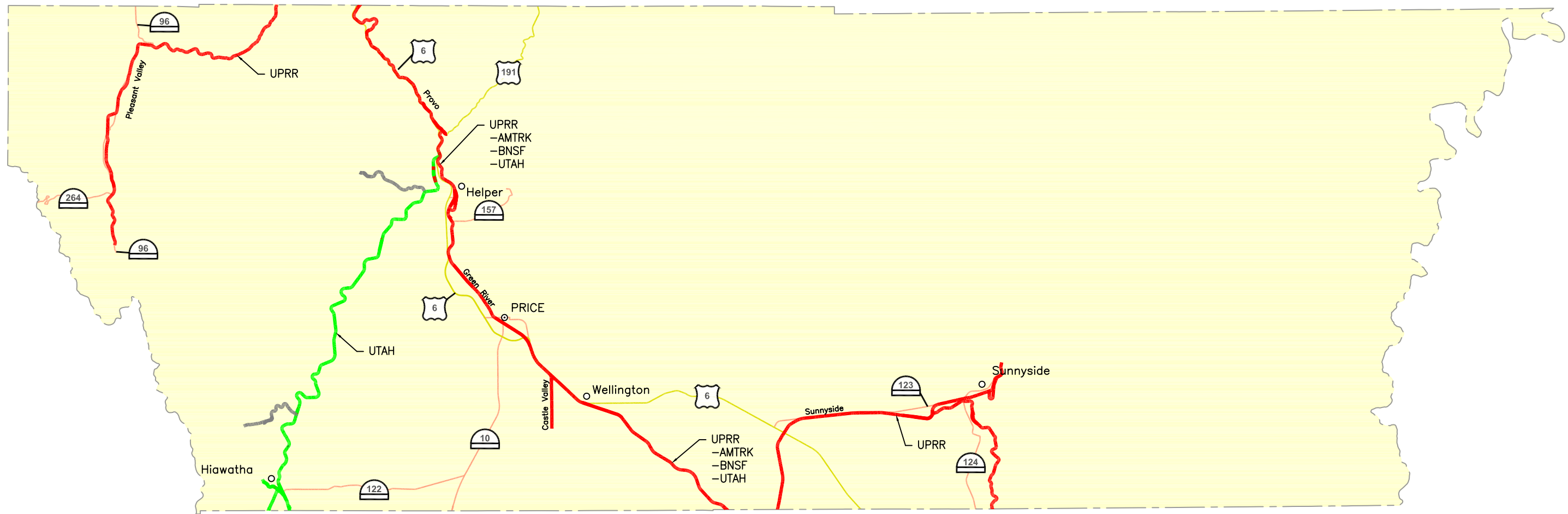

**CARBON COUNTY
RAILROAD & HIGHWAY
LOCATION MAP**

LEGEND

- INTERSTATE
- U.S. HIGHWAY
- STATE HIGHWAY
- UNION PACIFIC RAILROAD
- UTAH RAILWAY
- ABCD TRACK OWNER
- ABCD OPERATING RIGHTS

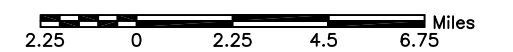

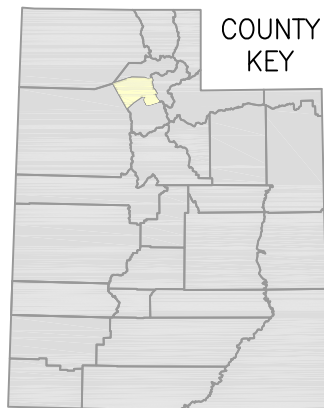
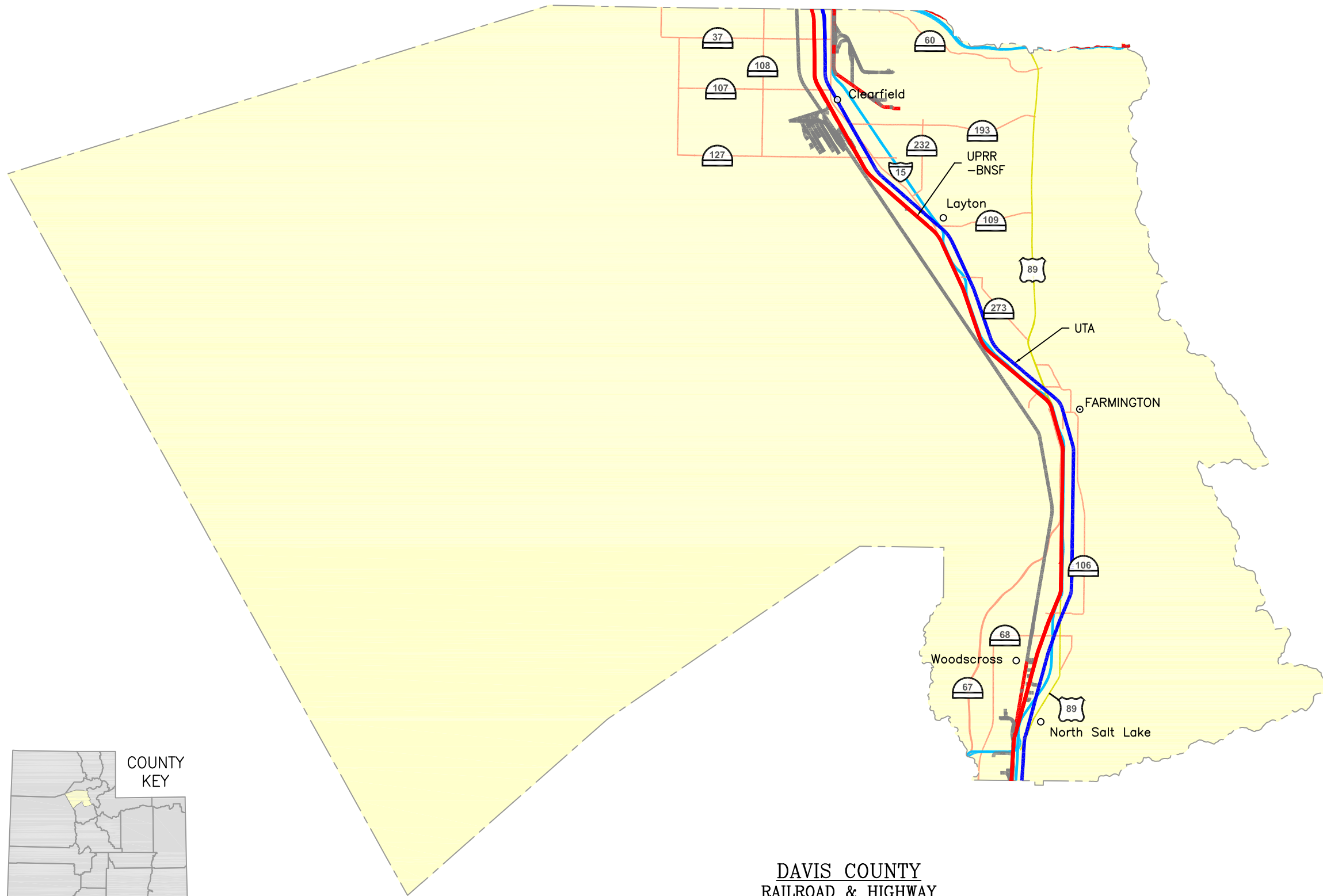

DAVIS COUNTY
RAILROAD & HIGHWAY
LOCATION MAP

LEGEND

- INTERSTATE
 - U.S. HIGHWAY
 - STATE HIGHWAY
 - UNION PACIFIC RAILROAD
 - UTAH TRANSIT AUTHORITY
 - UNSPECIFIED
(PRIVATE, ABANDONED, ETC...)
- ABCD TRACK OWNER
-ABCD OPERATING RIGHTS

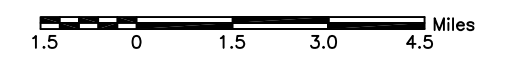

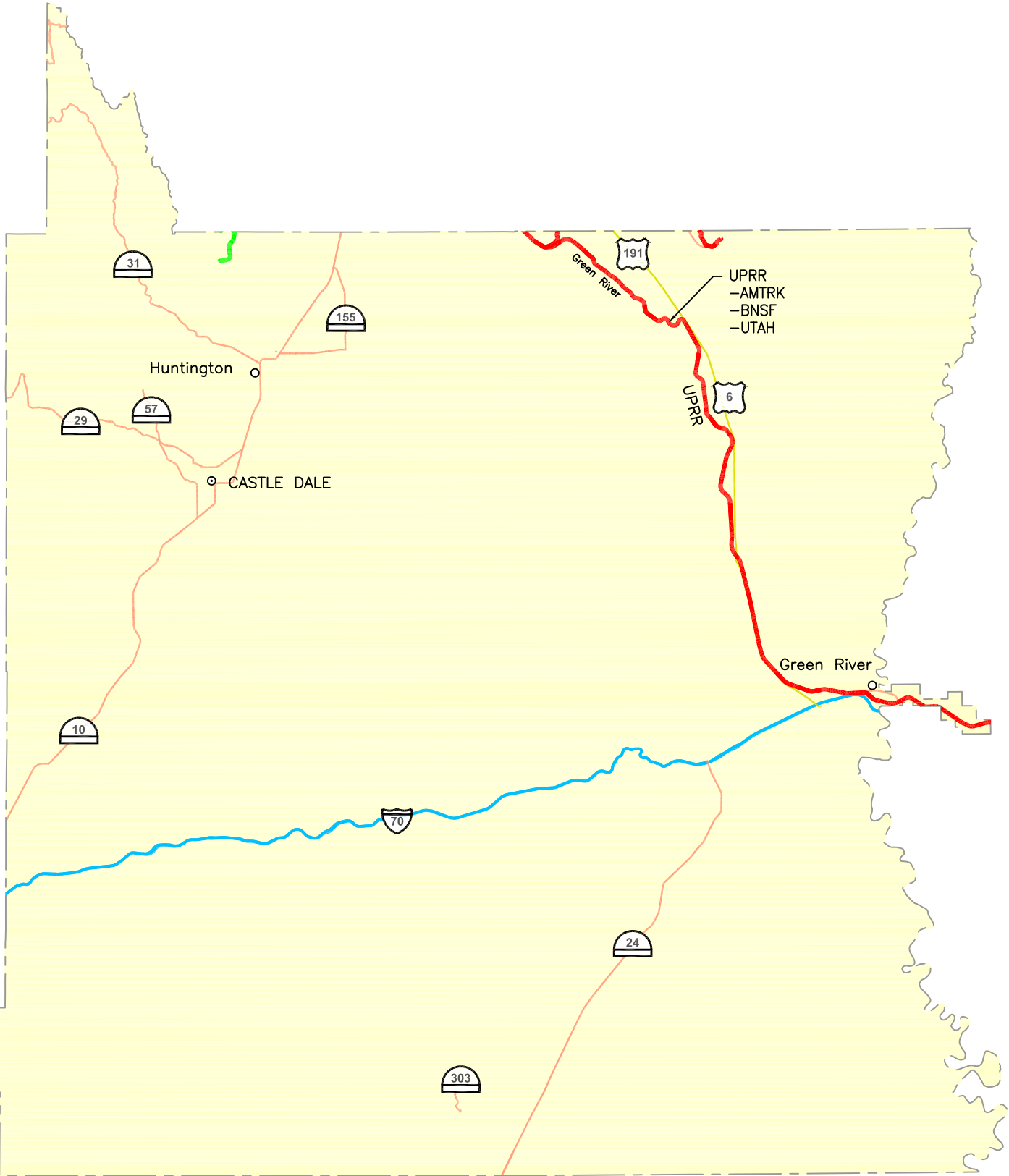

EMERY COUNTY
RAILROAD & HIGHWAY
LOCATION MAP



LEGEND

- INTERSTATE
- U.S. HIGHWAY
- STATE HIGHWAY
- UNION PACIFIC RAILROAD
- ABCD TRACK OWNER
- ABCD OPERATING RIGHTS

N

4.5 0 4.5 9.0 13.5 Miles

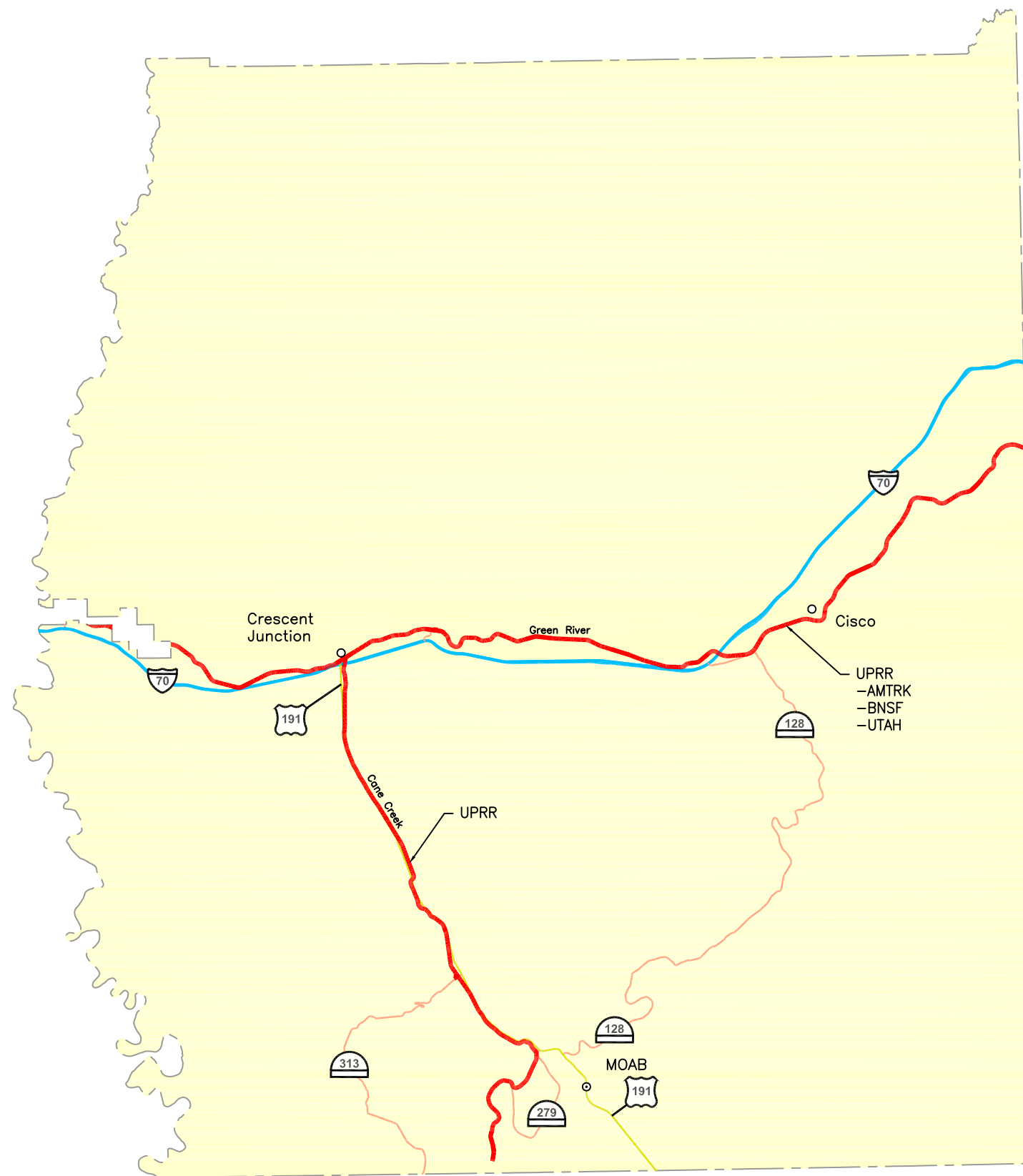

GRAND COUNTY
RAILROAD & HIGHWAY
LOCATION MAP

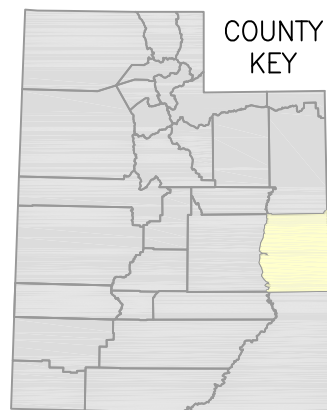

LEGEND

- INTERSTATE
- U.S. HIGHWAY
- STATE HIGHWAY
- UNION PACIFIC RAILROAD
- ABCD TRACK OWNER
- ABCD OPERATING RIGHTS

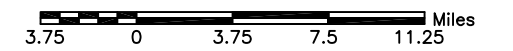

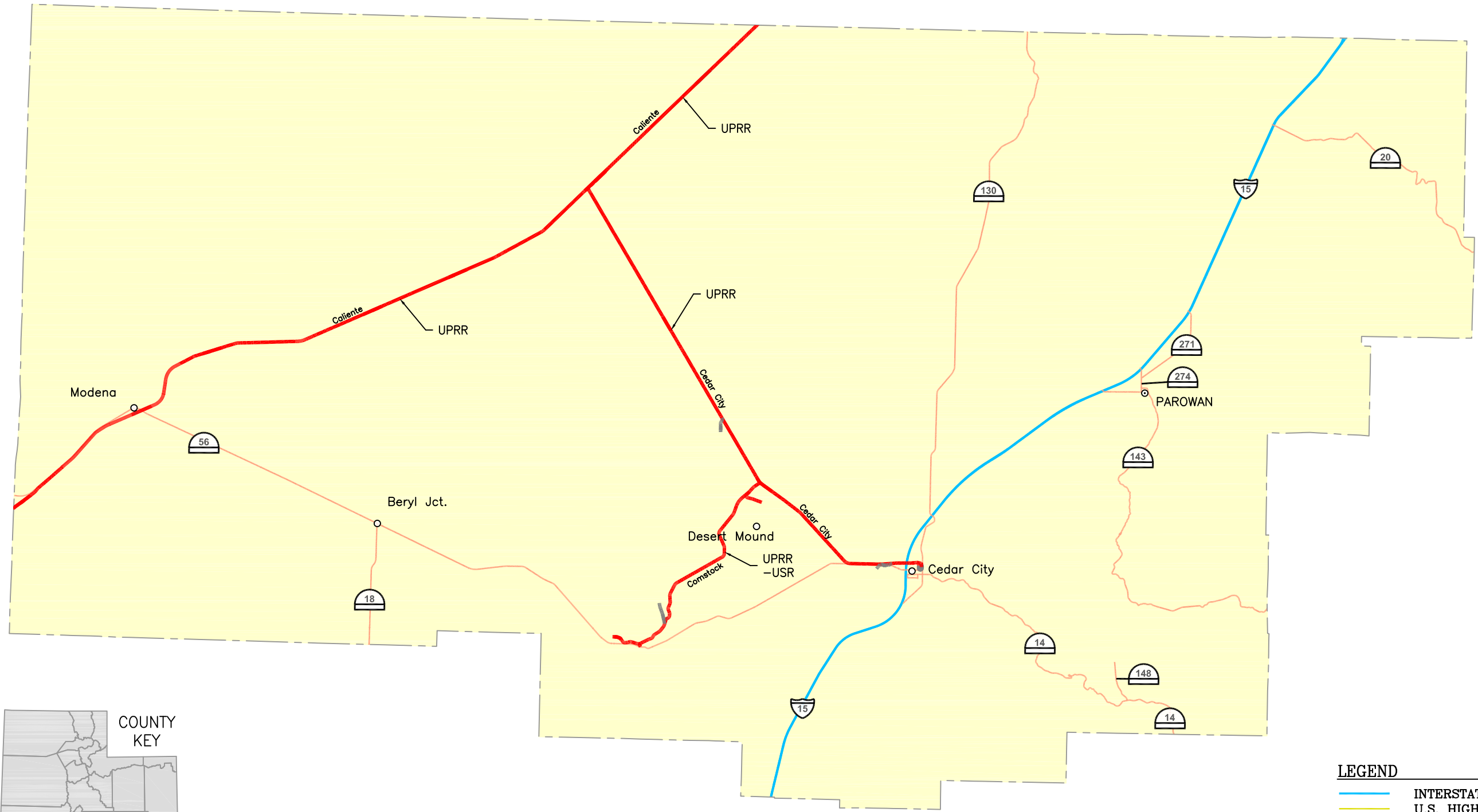

**IRON COUNTY
RAILROAD & HIGHWAY
LOCATION MAP**

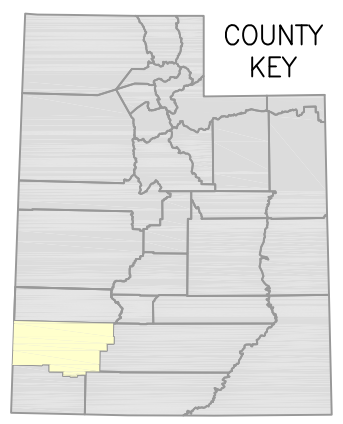

LEGEND

	INTERSTATE
	U.S. HIGHWAY
	STATE HIGHWAY
	UNION PACIFIC RAILROAD
ABCD	TRACK OWNER
-ABCD	OPERATING RIGHTS

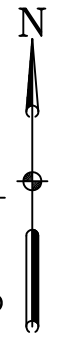
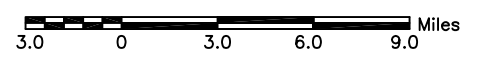

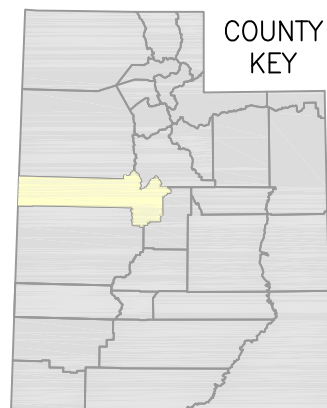
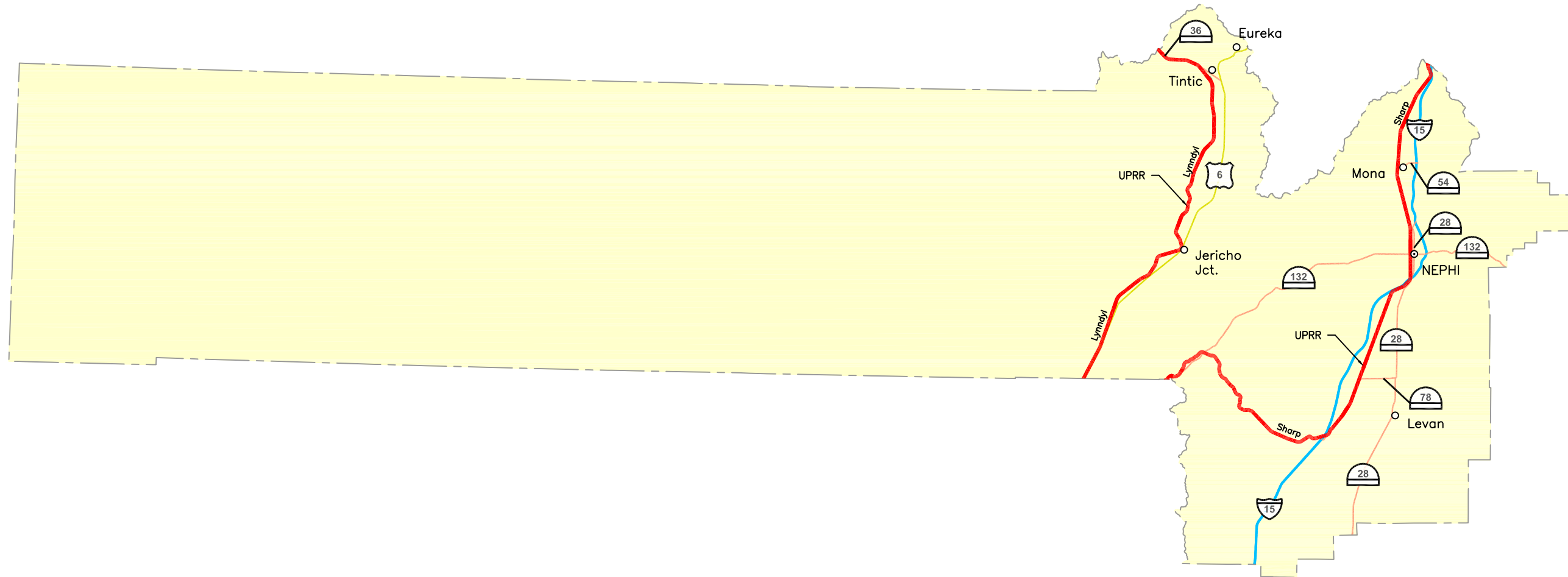

JUAB COUNTY
RAILROAD & HIGHWAY
LOCATION MAP

LEGEND



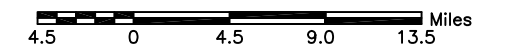

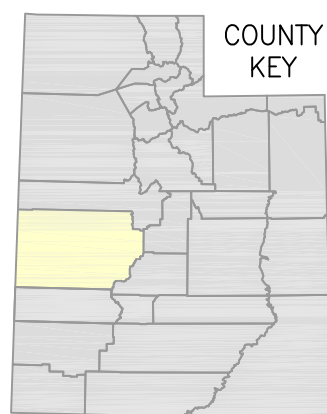
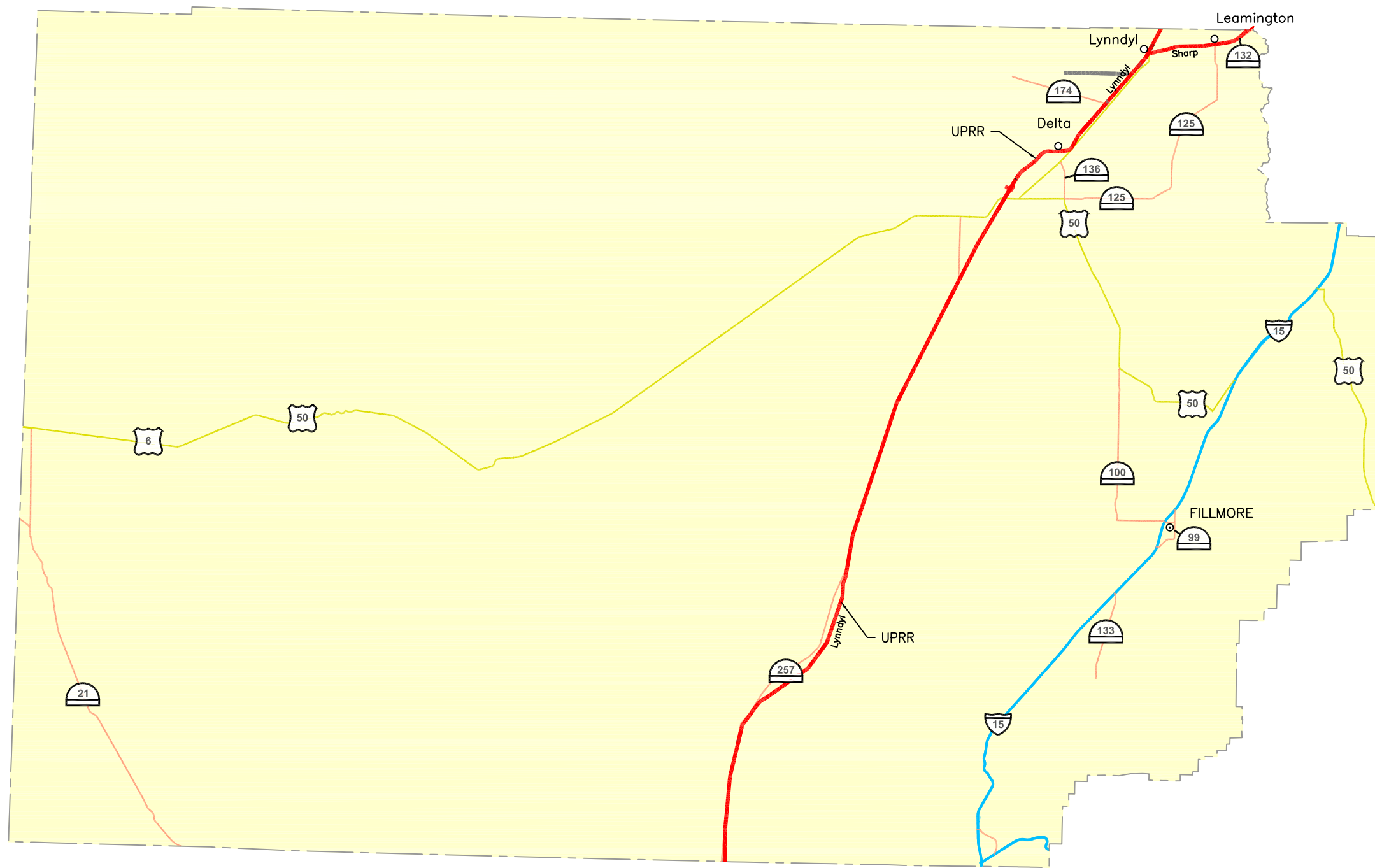
- INTERSTATE
- U.S. HIGHWAY
- STATE HIGHWAY
- UNION PACIFIC RAILROAD
- ABCD TRACK OWNER
- ABCD OPERATING RIGHTS





**MILLARD COUNTY
RAILROAD & HIGHWAY
LOCATION MAP**

LEGEND

	INTERSTATE
	U.S. HIGHWAY
	STATE HIGHWAY
	UNION PACIFIC RAILROAD
ABCD	TRACK OWNER
-ABCD	OPERATING RIGHTS

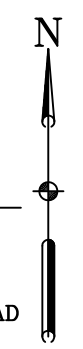
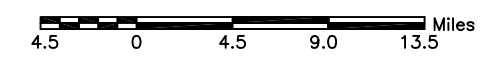

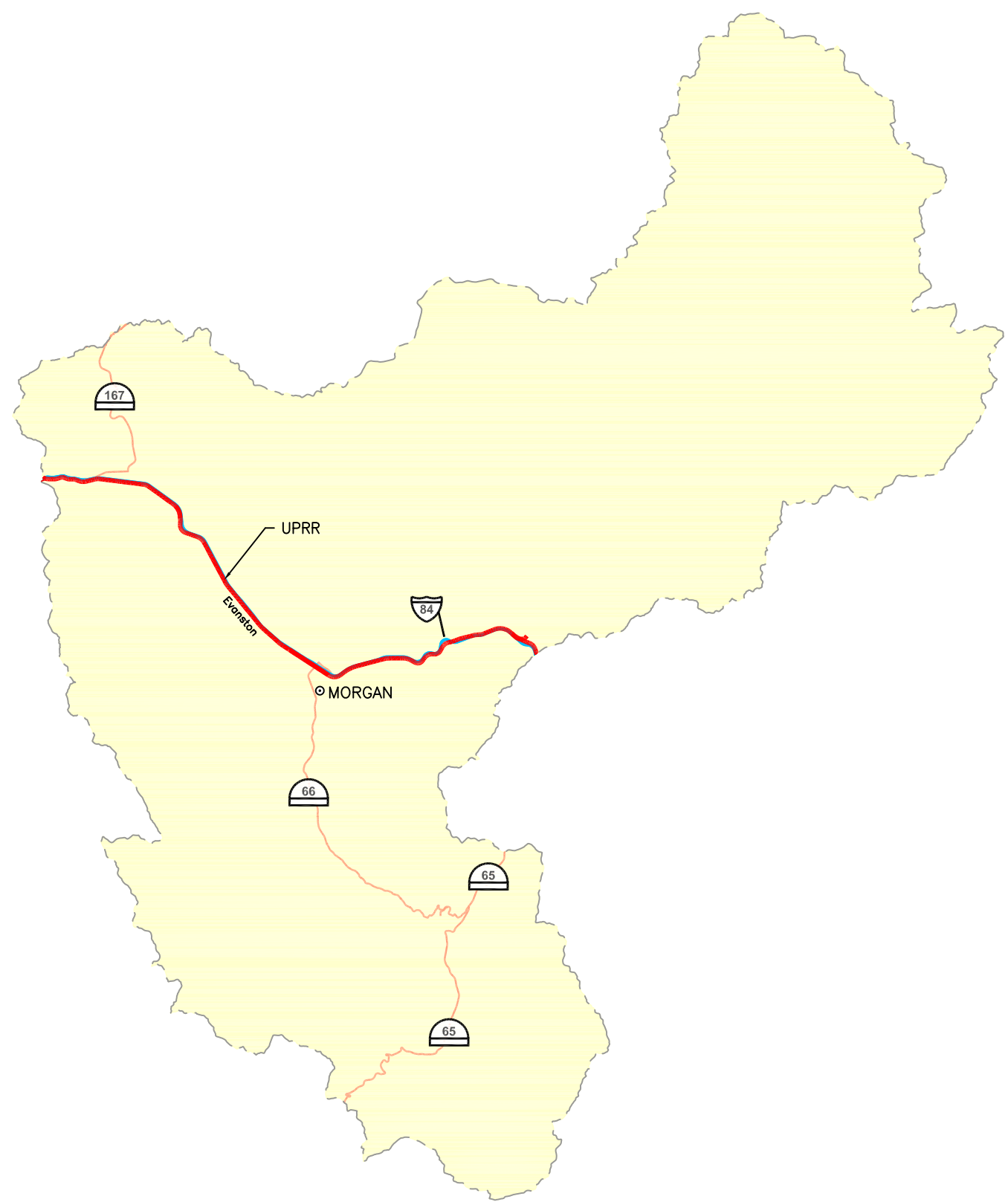

MORGAN COUNTY
RAILROAD & HIGHWAY
LOCATION MAP

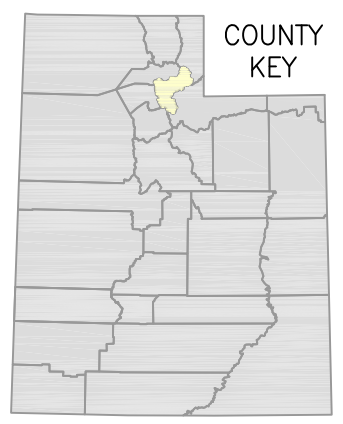

LEGEND

- INTERSTATE
- U.S. HIGHWAY
- STATE HIGHWAY
- UNION PACIFIC RAILROAD
- ABCD TRACK OWNER
- ABCD OPERATING RIGHTS

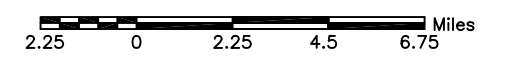
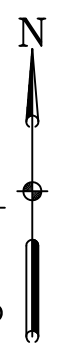

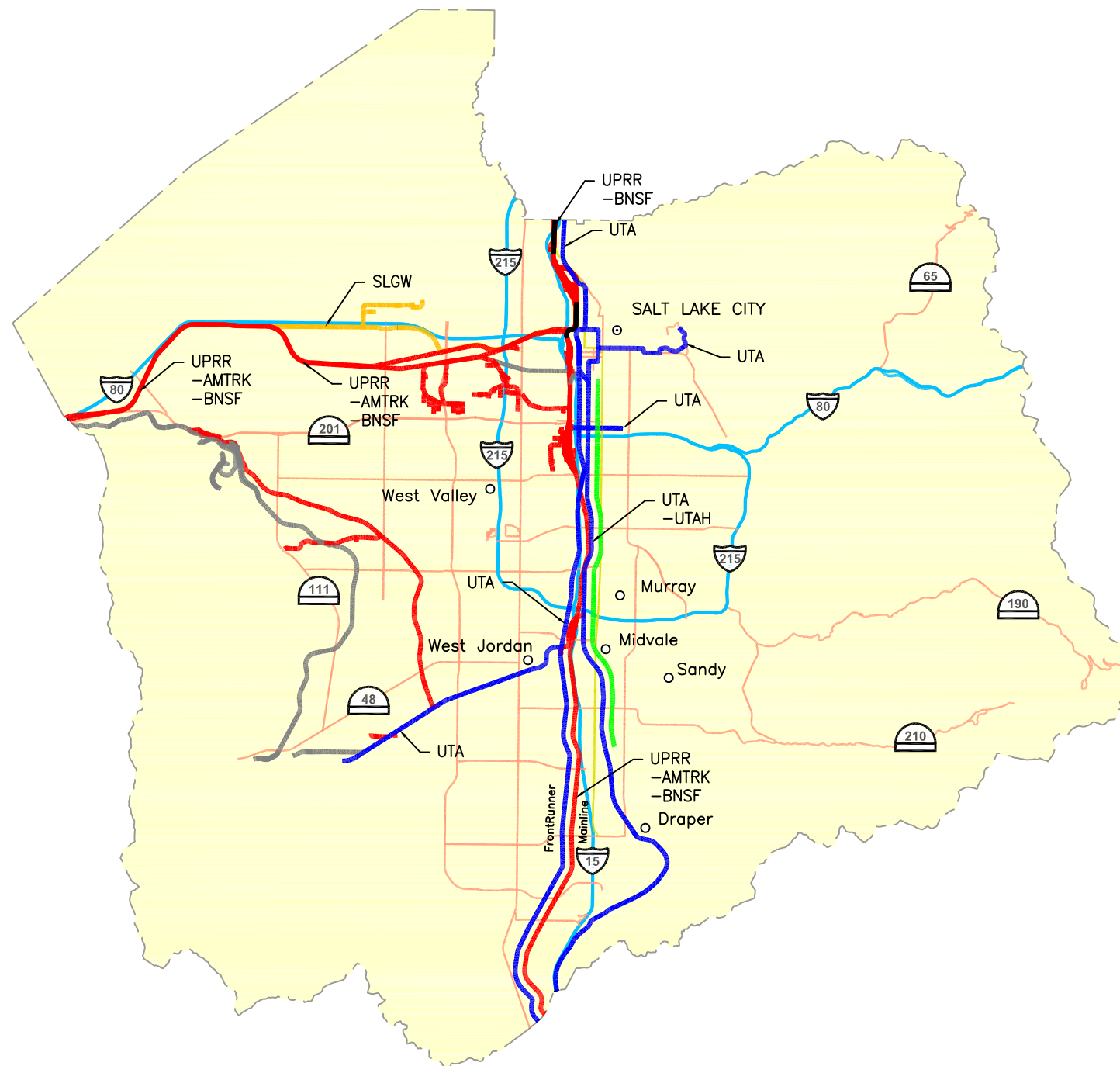

SALT LAKE COUNTY
RAILROAD & HIGHWAY
LOCATION MAP

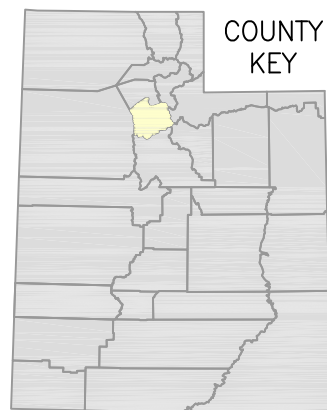

LEGEND

- INTERSTATE
 - U.S. HIGHWAY
 - STATE HIGHWAY
 - UNION PACIFIC RAILROAD
 - UTAH TRANSIT AUTHORITY
 - UTAH RAILWAY
 - SLGW
- ABCD TRACK OWNER
-ABCD OPERATING RIGHTS

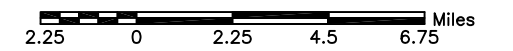

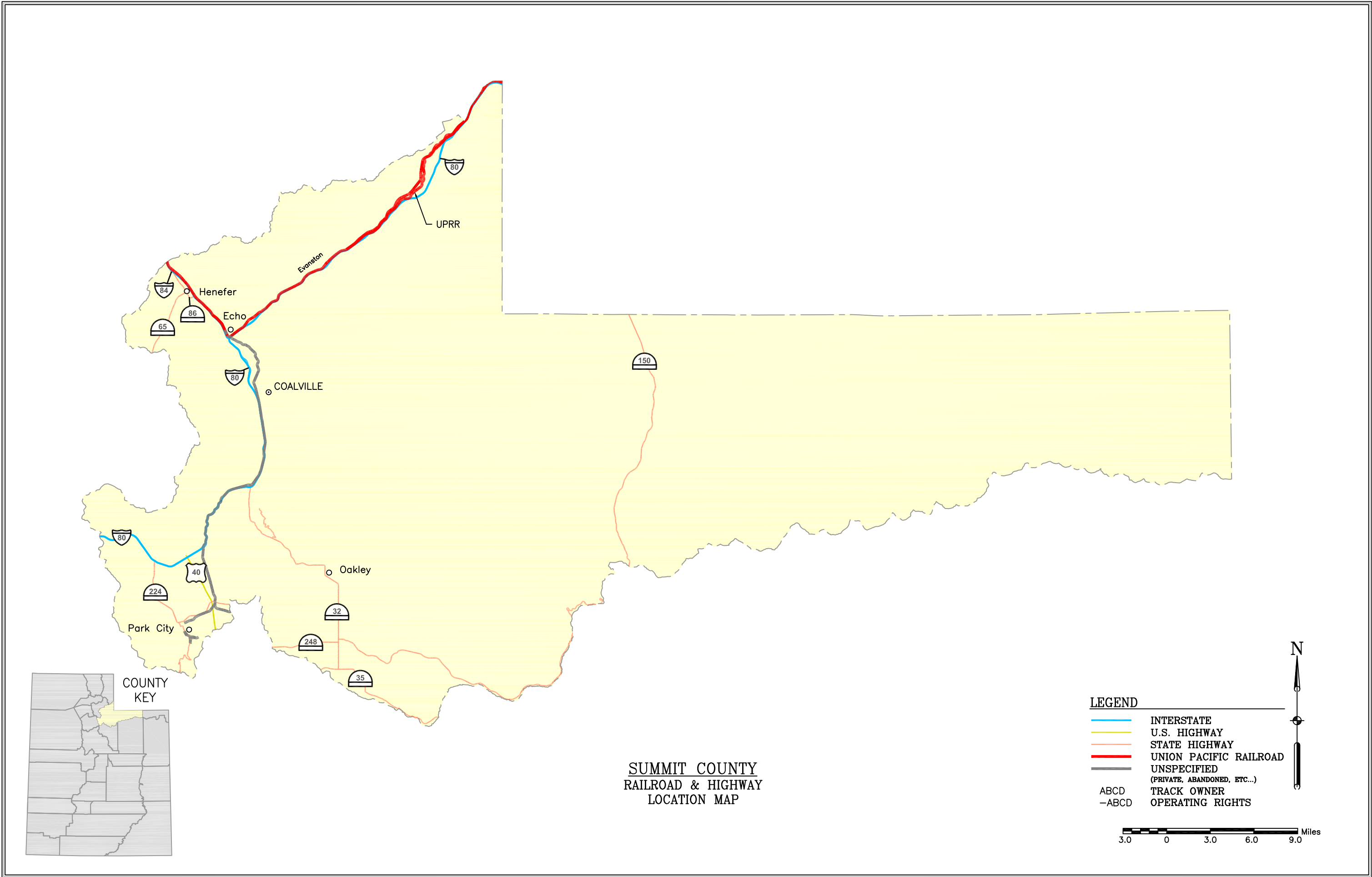



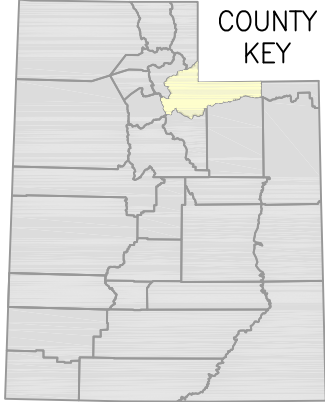

**SUMMIT COUNTY
RAILROAD & HIGHWAY
LOCATION MAP**



LEGEND

	INTERSTATE
	U.S. HIGHWAY
	STATE HIGHWAY
	UNION PACIFIC RAILROAD
	UNSPECIFIED (PRIVATE, ABANDONED, ETC...)
ABCD	TRACK OWNER
-ABCD	OPERATING RIGHTS

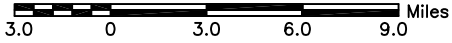

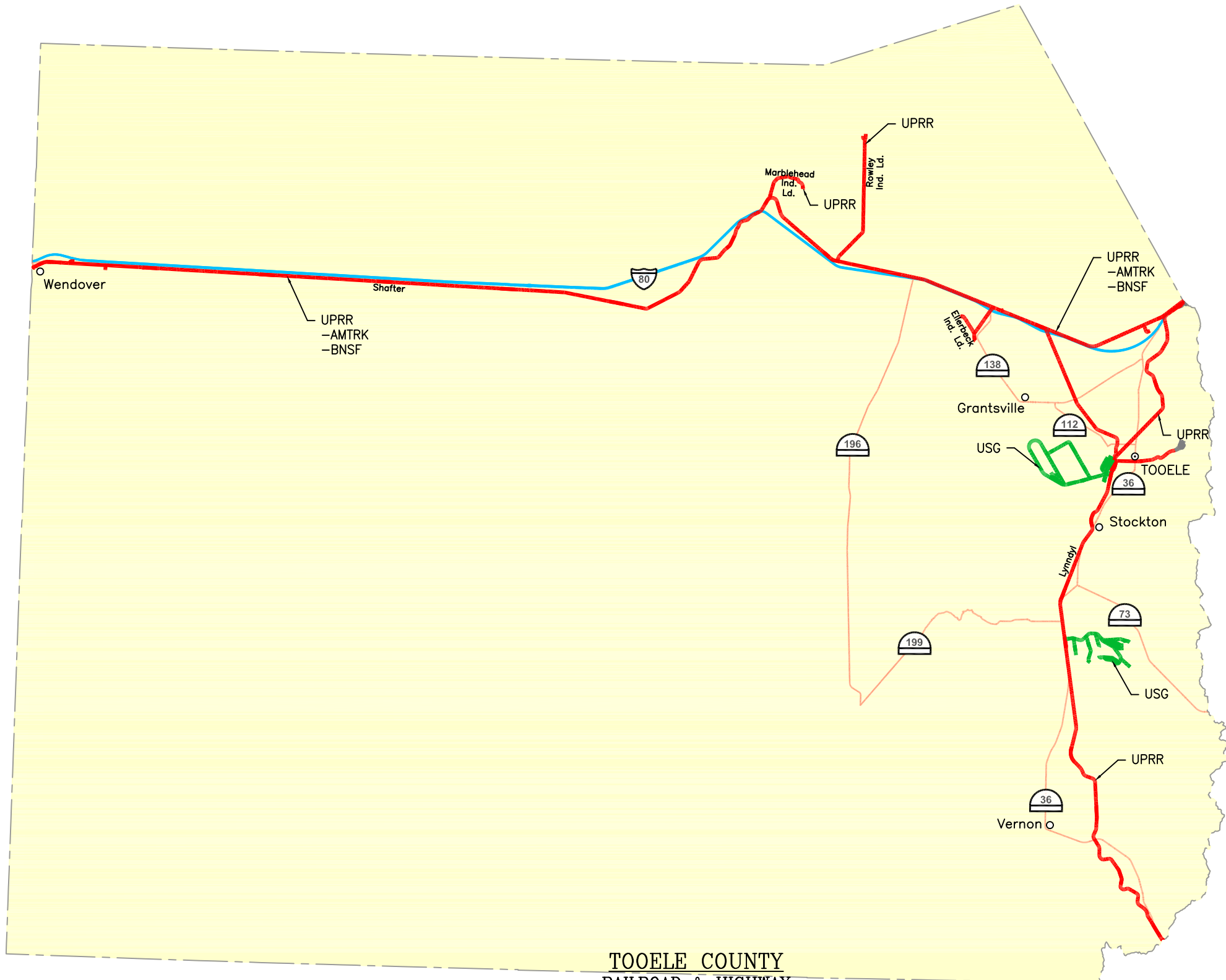

TOOELE COUNTY
RAILROAD & HIGHWAY
LOCATION MAP

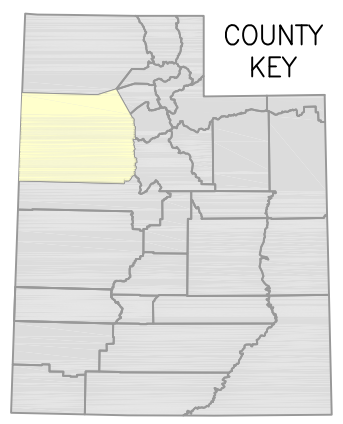

LEGEND

- INTERSTATE
- U.S. HIGHWAY
- STATE HIGHWAY
- UNION PACIFIC RAILROAD
- U.S. GOVERNMENT
- ABCD TRACK OWNER
- ABCD OPERATING RIGHTS

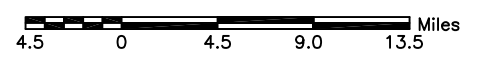

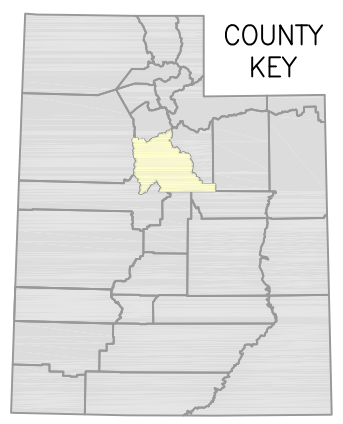
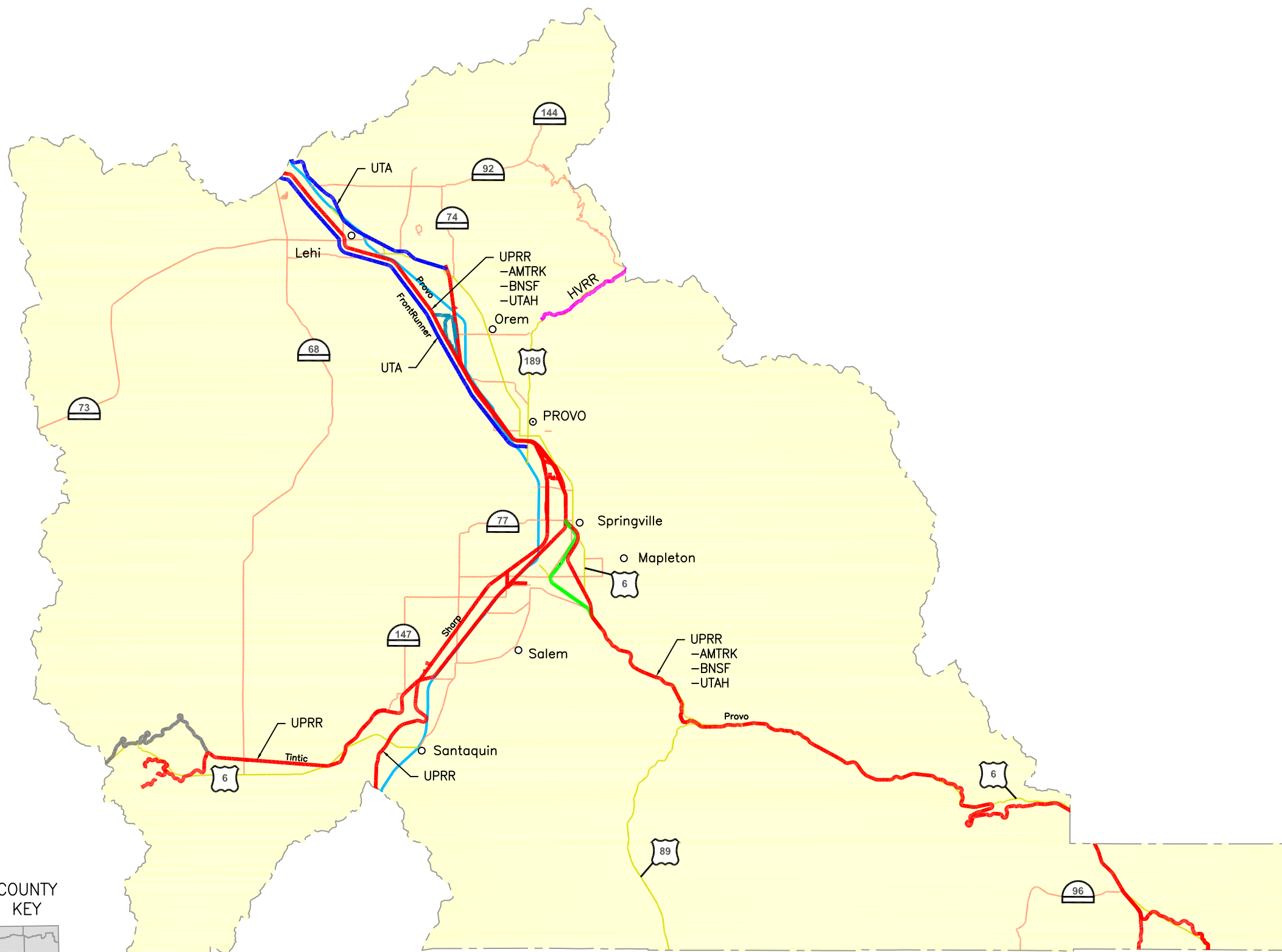

UTAH COUNTY
RAILROAD & HIGHWAY
LOCATION MAP

- LEGEND**
- INTERSTATE
 - U.S. HIGHWAY
 - STATE HIGHWAY
 - UNION PACIFIC RAILROAD
 - UTAH TRANSIT AUTHORITY
 - HEBER VALLEY RAILROAD
 - ABCD TRACK OWNER
 - ABCD OPERATING RIGHTS

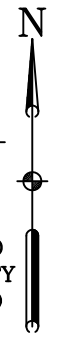
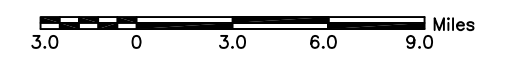

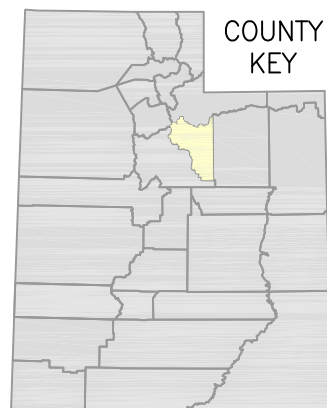
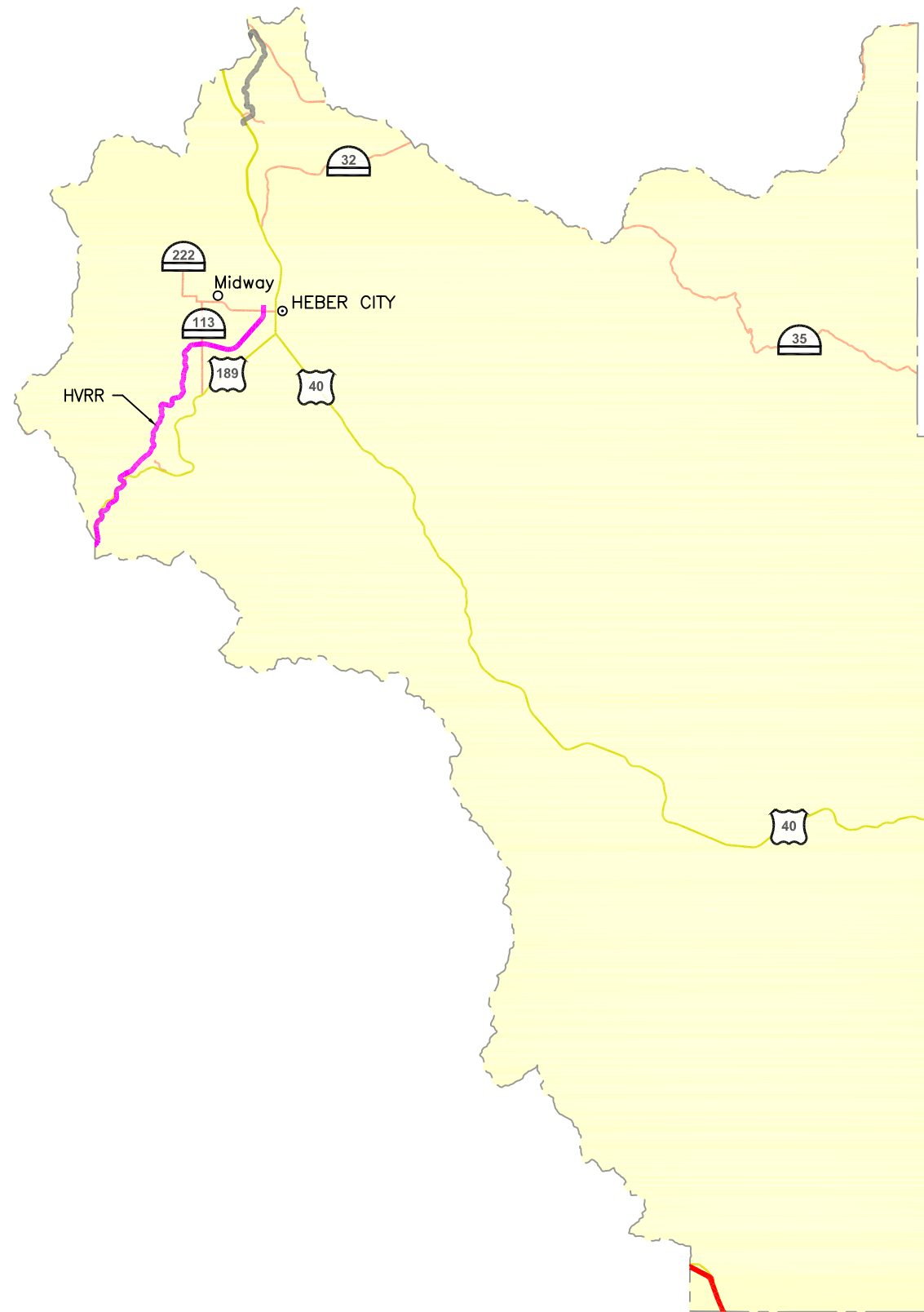

WASATCH COUNTY
RAILROAD & HIGHWAY
LOCATION MAP

LEGEND

- INTERSTATE
- U.S. HIGHWAY
- STATE HIGHWAY
- HEBER VALLEY RAILROAD
- ABCD TRACK OWNER
- ABCD OPERATING RIGHTS

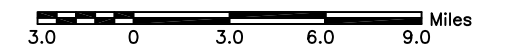

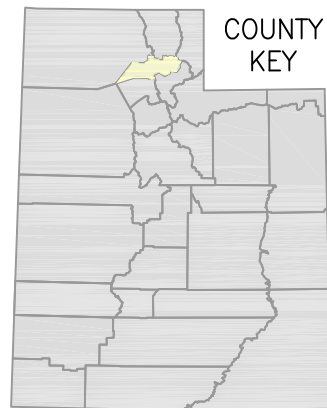
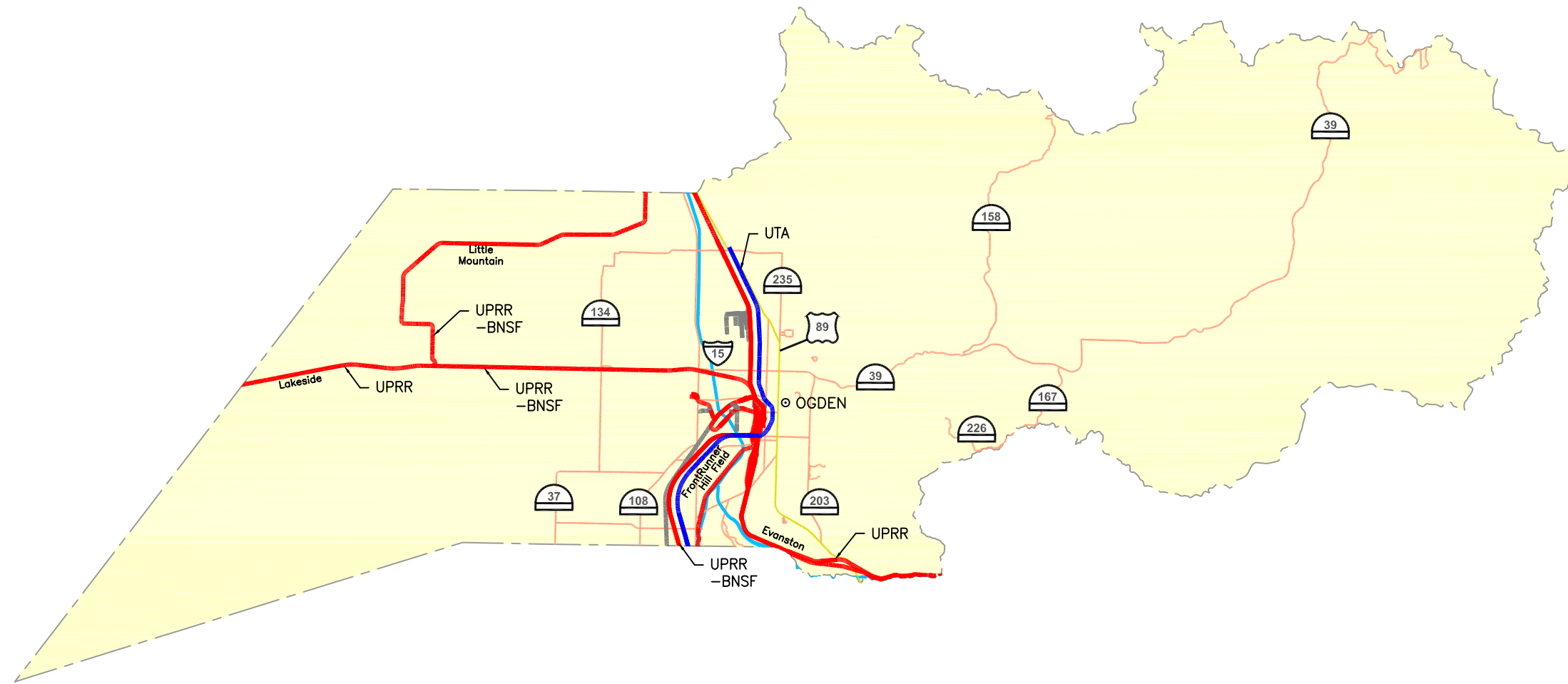

**WEBER COUNTY
RAILROAD & HIGHWAY
LOCATION MAP**

LEGEND

- INTERSTATE
- U.S. HIGHWAY
- STATE HIGHWAY
- UNION PACIFIC RAILROAD
- UTAH TRANSIT AUTHORITY
- ABCD TRACK OWNER
- ABCD OPERATING RIGHTS

